

JACKSON[®]

SAFETY

RESPIRATORY PROTECTION

WELDING PROTECTION

TOOLS

FACE & EYE PROTECTION

GENERAL PPE



2021

SAFETY PRODUCTS

EUROPEAN CATALOGUE

A/Une/Eine/Una/La



Brand / Marque / Marke / Marca

BE SMART. BE SAFE. BE SURE.

Follow us on Facebook
SureWerx Europe



JACKSON
SAFETY

sellstrom

duenorth

BALDER
TECHNOLOGY

WILSON

CURV-0-MARK

K1
SERIES

JACKSON[®]

SAFETY

OUR NEW WEBSITE IS LIVE

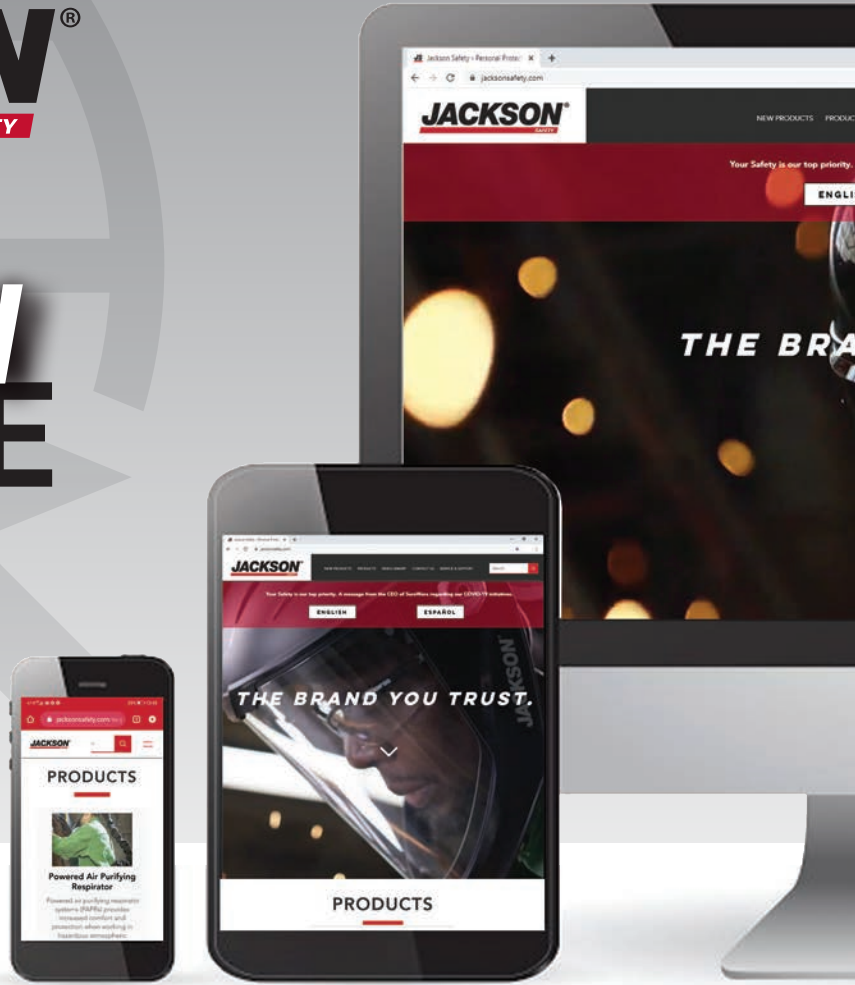

NEW PRODUCT ANNOUNCEMENT



SELL SHEETS



A / Une / Eine / Una / La

SureWerx™
Brand / Marque / Marke / Marca

Ordering E-mail sales@jacksonsafety.eu
Customer Service +386 1 477 67 84
www.jacksonsafety.eu



ABOUT SureWerx

BE SMART. BE SAFE. BE SURE.

Co-headquartered in Vancouver, British Columbia, and Elgin Illinois, SureWerx™ is a leading supplier of professional tool, equipment and safety products for workers. SureWerx markets its products in Canada under the JET®, Strongarm®, ITC®, STARTECH®, Pioneer®, Ranpro®, PeakWorks®, Jackson®, Wilson®, Curv-O-Mark®, Due North® and Sellstrom® brands, and in the United States under the American Forge & Foundry®, Pioneer®, PeakWorks®, Jackson®, Wilson®, Curv-O-Mark®, Due North®, Geroline/K1 and Sellstrom® brands. And now in Europe under our Jackson®, Sellstrom®, Due North®, Geroline/ K1, Balder® and Curv-O-Mark® brands, SureWerx™ offers unparalleled access to its brands through its partner distributor network servicing the industrial, construction, safety, and automotive aftermarket in North America and Europe.

www.surewerx.com

NAM



"We want all of our distributor partners and the end users of our products to experience tangible value for the products and services we offer and we will continue to enhance that proposition vastly over the coming years"

— A message from our CEO, Chris Baby

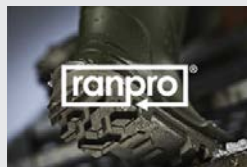

Building a tool & equipment business

1957–2000

● Acquires Pioneer

● Acquires PeakWorks

● Acquires Sellstrom

● Acquires Ranpro

● Establishes STARTECH

2009–today

Building a health, safety and productivity business

2009

2014

2015

OUR COMMITMENT TO THIS REGION

To bring a range of feature rich PPE products and services to our distributor partners in the industrial, automotive, safety, medical and food markets.

As we only sell our own brands we control the appropriate certification of the products and the quality of the manufacture.

Our new catalogue includes new 'exclusive' products in the following categories:

- PAPER systems
- Welding helmets
- Auto Darkening Filters
- Welding blankets and curtains
- Tools
- Head, face and eye protection
- Knee protection
- Slip protection

OUR FUTURE COMMITMENT TO THE REGION

- Continue to bring new 'exclusive' certified products to the markets.
- Invest in the systems, processes and people to deliver the best customers experience.
- Invest in your businesses with training and Marketing support.

EMEA

Europe, Middle East and Africa

JACKSON
SAFETY

sellstrom

duenorth

BALDER
TECHNOLOGY

WILSON

CURV-0-MARK

KI MID-SOLE
ICE CLEAT

www.jacksonsafety.eu

"Our acquisition of Jackson Safety provided us with a platform in Europe on which we intend to build a comprehensive health, safety and productivity focused business. We have a successful track record in achieving this goal in other regions and will draw on that legacy to deliver the best customer experience in Europe. Our investment is already considerable and this catalogue reflects our commitment to delivering the right products to the worker to ensure they are totally confident of their health and safety and can concentrate on their productivity and delivering their best work."



— A message from Clive Shepherd
GM/VP - EMEA Region



● Acquires KP Industries

● Acquires Jackson Safety and Wilson Brands

● Acquires ADA Solutions and Due North

● Acquires Geroline

2016

2018

2019

2020

YOUR BEST WORK YET... NEEDS YOUR TOTAL FOCUS

The safety and productivity of every professional worker is our goal. Our mission is to design products that deliver on this goal. We are always finding better ways help increase worker productivity and safety.



Every day 100's of professional workers are injured at work - industrial accidents are avoidable.



Our goal is to ensure that you return home, after a safe and productive day at work, in the same healthy condition as you went to work.



Legislation and regulation continue to increase safety at work and all of our products will meet or exceed the necessary levels.



We also work to ensure that all of our distributors receive product knowledge training to ensure they provide the right product for the right application. We are committed to understanding the needs of the professional end users.



When workers are confident that their PPE is designed with their health and safety in mind they can concentrate on the job at hand, achieving maximum productivity.

• **ACCIDENTS**

• **INJURIES**

• **RISK**

Reduce





Increase ● ● ● ●

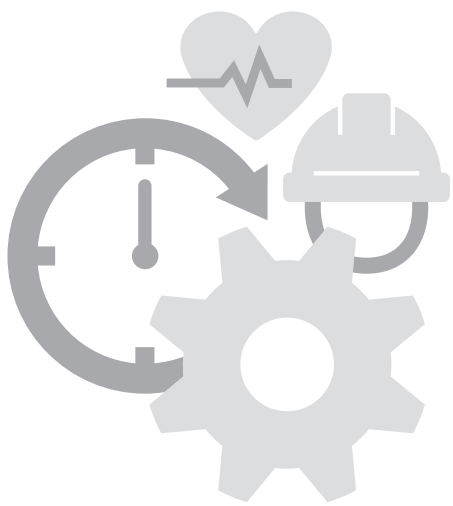

**HEALTH
SAFETY
PRODUCTIVITY**
Finding a better way

JACKSON[®]
SAFETY



YOUR BEST WORK YET NEEDS THE RIGHT PRODUCT FOR THE RIGHT APPLICATION



10 RESPIRATORY PROTECTION

	Page
PAPR Welding	14-25
PAPR Face Shield	26-27
PAPR Soft Hood	28-29

30 WELDING PROTECTION

Welding Helmets	34-59
Welding Filters	60-67
Welding Blankets	68-71
Welding Curtains	72-73

74 TOOLS

Curv-O-Mark	74-77
-------------	-------

78 FACE & EYE PROTECTION

Face Shields	82-89
Goggles	90-93
Glasses	94-99

100 GENERAL PPE

Head Protection	102
Headlamps	103
Hearing Protection	104-109
Knee Protection	110-111
Slip Protection	112-118

Product Index	119-121
---------------	---------

Warranty Table	121
----------------	-----

MARKET FOCUS

INDUSTRIAL

CONSTRUCTION

METAL
FABRICATION

AUTOMOTIVE

AGRICULTURE

FOOD
PROCESSING

MEDICAL



RESPIRATORY PROTECTION PPE

YOUR HEALTH MATTERS



Health hazards associated with welding processes typically include exposures to ultraviolet (UV) radiation and intense visible light that have the potential to cause eye damage. Physical eye hazards include welding spatter and grinding particles. Professional welders know about these hazards and provide protection with welding helmets and auto-darkening welding filters.

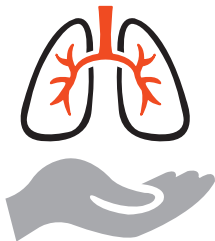

But other hazards - like **welding fumes, which contain particles** - are sometimes not as well known and may not be addressed. Prolonged exposure to welding fumes can lead to cancer of the lung, larynx and urinary tract, as well as nervous system and kidney damage.

REDUCE EXPOSURE TO HAZARDS

● Understand the risks

Identify the hazard - metal fumes, gases, vapours, mist, dust.
The selection of respiratory protection should be the result of the **risk assessment** conducted by a professional health and safety officer.

● Maintain clean surfaces

Welding surfaces should be cleaned of any coating that could potentially result in toxic exposure levels.

● Avoid breathing fume and gases

Position yourself to avoid breathing fume and gas, for example, stay upwind of welding fumes when working in open or outdoor areas. Be aware that welding outdoors or in open work environments does not guarantee safe ventilation.

● Use general or local ventilation

PAPR is not suitable for work in poorly ventilated areas where oxygen level is suspected to be below 17%.

Ventilation can reduce fume and gas levels in the work area and remove fume and gases from the welder's breathing zone.

● Wear respiratory protection

Chose the right respiratory protection and reduce exposures to safe levels.

PROTECTION CLASSIFICATION

GOOD

TH1

inward
leakage
max. **10%**

NPF = 10

BETTER

TH2

inward
leakage
max. **2%**

NPF = 50

BEST

TH3

inward
leakage
max. **0.2%**

NPF = 500

NPF - Nominal Protection Factor

Based on EN 12941

Awareness is the first step in controlling hazards. Investing in the right personal protective equipment creates a healthier, safer and more productive workplace.

Metal fumes



Fine, airborne particles from metal generated by condensation of vaporized material at high temperatures.

Gases



A normally formless fluid, often odourless and invisible, can spread freely and quickly through the air.

Vapours



Gases formed when solids or liquids evaporate at room temperatures.

Mist



Tiny liquid droplets generated by condensation or by breaking up a liquid into the dispersed state, in processes such as spraying.

Dust



Particulate matter formed when solid matter is broken down into fine, airborne particles. In welding about 95% is particle filtration.



HEALTH SAFETY

PRODUCTIVITY

Finding a better way

PAPR SYSTEMS

	NEW GOOD	NEW BETTER	NEW BEST	
HEADTOPS	● ● ●	● ● ●	● ● ●	● ● ●
	WH25 DUO	TRANSLIGHT 355	TRANSLIGHT FLIP 455	
				
	TH3	TH3	TH3	TH3
PAPR SYSTEMS				
	AIRMAX	AIRMAX+	AIRMAX+	AIRMAX+
		IP 5 4	IP 5 4	IP 5 4



NEW

NEW

NEW

● ● ●
**TRANSLIGHT+
555**



TH3



AIRMAX+

IP 5 4

● ● ●
WH70



TH3



AIRMAX Elite

● ● ●
F50

Face Shield



TH3



AIRMAX+

IP 5 4

● ● ●
SOFT HOOD

White

Black



TH3



AIRMAX+

IP 5 4

NEW

PAPR Welding

JACKSON[®]
SAFETY

Best in Class Protection

NEW /
NOUVEAU /
NEU /
NUOVO /
NUEVO /

TH3 P R SL
PAPR SYSTEM

Jackson Safety® PAPR Welding



AIRMAX® with DUO

AIRMAX PAPR System with
DUO PAPR Welding Helmet

- **TH3 P R SL** best in class (see table opposite)
- Operation time up to **9 hours**
- **Light weight 990g** (blower unit, battery and filter)
- P3 filter with increased surface area
- Easy to operate
- Replaceable and rechargeable 4 cell Li-ion battery 7.4V/5200mAh. Charging time: 5 hours
- Replacement filter available
- Fitted with **flame retardant supporting belt** and **hose cover** for prolonged operational time
- Noise level 75dBA

TH1	TH2	TH3
inward leakage max. 10%	inward leakage max. 2%	inward leakage max. 0.2%
NPF = 10	NPF = 50	NPF = 500

NPF - Nominal Protection Factor

Based on EN 12941

A / Une / Eine / Una / La



Brand / Marque / Marke / Marca

Ordering E-mail sales@jacksonsafety.eu

Customer Service +386 1 477 67 84

www.jacksonsafety.eu



More details about the DUO welding helmet on pages 40/41.

EN 12941:1998+A1:2003+A2:2008
TH3 P R SL



> 20 Amp



AIRMAX PAPR SYSTEM

Product No	Description	Pack Qty
J7050	AIRMAX PAPR System with Duo Welding Helmet 4/9-13 ADF - Single Speed	1

SPARE PARTS & ACCESSORIES

Product No	Description	Pack Qty
J7063	AIRMAX Welding PAPR FR Hose & Cover	1
J5241	AIRMAX Welding PAPR FR Hose Cover	1
J7065	AIRMAX Welding PAPR Motor	1
J7210	AIRMAX Welding P3 PAPR Filter	6
J7067	AIRMAX Welding PAPR Charger	1
J7068	AIRMAX Welding PAPR 4C Battery	1
J7069	AIRMAX Welding PAPR Waist Belt	1
40391	PAPR Carrying Bag - optional extra	1
J7061	DUO PAPR Face Seal	10

Jackson Safety® PAPR Systems

AIRMAX+®

AIRMAX+ PAPR System - Blower

- **TH3 Particle Protection - Highest Possible Rating**
- Air flow: **180 to 260 lpm (10 lpm Increment)**
- Blower System comes with **8 different blower speed settings**
- **IP 54 Certified** – Protects against dust (limited ingress, no harmful deposits) and water splash from all directions (limited ingress permitted)
- **Vibration and Audible Filter Alarms** to inform when filters need changing or low battery
- Comes with replaceable and rechargeable **HD 4 Cell Li-ion Battery 7.4V/5200mAh**. Charging time: 5 hours
- Operation time up to **10 hours** with a new filter P R SL and airflow 180 l/min
- Unit contains battery charger, battery, waist belt, hose, HEPA Filter, Pre-Filter, (odour removing filter sold separately)
- Compatible with Translight 355, Translight Flip 455, and Translight+ 555 Welding Helmet kits
- Sleek controls, large enough to use with oversized gloves
- Unit is CE Certified

Compatible with:

- **TRANSLIGHT series**
- **F50 Face Shield**
- **Soft Hood**

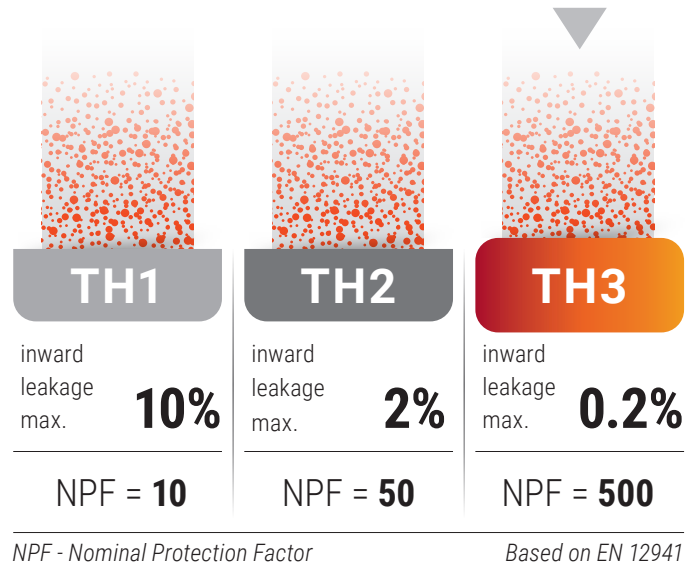

40381

Exclusive **IP54** rating protects the blower unit against water splashes, and allows easy cleaning and disinfecting when used in medical settings



INGRESS PROTECTION RATING

IP 54



SOLID

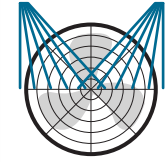

WATER

- 1** Protected against solid objects greater than 50 mm such as a hand.
- 2** Protected against solid objects greater than 12.5 mm such as a finger.
- 3** Protected against solid objects greater than 2.5 mm such as screwdriver.
- 4** Protected against solid objects greater than 1 mm such as a wire.
- 5** Dust protected. Prevents ingress of dust sufficient to cause harm.
- 6** Dust tight. No ingress of dust.

- 1** Protected against vertically falling drops of water.
- 2** Protected against direct sprays of water up to 15° from the vertical.
- 3** Protected against direct sprays of water up to 60° from the vertical.
- 4** Protected against water splashed from all directions.
- 5** Protected against low pressure jets of water from all directions.
- 6** Protected against strong jets of water.
- 7** Protected against the effects of temporary immersion between 15 cm and 1 m for 30 minutes.
- 8** Protected against long periods of immersion under pressure.

CE 0082

Product No	Description	Pack Qty
40381	AIRMAX+ Blower unit - 8 Speed	1

SPARE PARTS & ACCESSORIES

Product No	Description	Pack Qty
40332	HEPA PAPR filter	1
40363	PAPR charger	1
40353	Replacement 4-Cell 7.4V Battery	1
40371	Replacement Waist belt	1
40311	Replacement Pre-filters	10
40312	Odour removing filter	10
40341	FR Hose with cover, 105 cm	1
40340	FR Hose with cover, 85 cm	1
J5241	FR Hose cover, 105 cm	1
J7064	Hose without cover, 85 cm	1

Jackson Safety® PAPR Welding

AIRMAX® with TRANSLIGHT™ 355

AIRMAX+ PAPR System with TRANSLIGHT 355 Welding Helmet

- **TH3** Particle Protection (Highest Possible Rating)
- **8 different** blower speed settings, adjustable airflow from 180 lpm to 260 lpm (**10 lpm Increment**)
- **IP 54** Certified
- **Vibration** and **Filter Alarms** to inform when filters need changing or low battery
- Comes with **HD 4 Cell Li-ion Battery 7.4V/5200mAh**. Charging time: 5 hours
- Operation time up to **10 hours** with a new filter P R SL and airflow 180 l/min
- In combination with Translight 355 welding helmet - featuring **ultra slim true color ADF** with **external mode control**
- Unit is CE Certified

Integrated air duct with hose connector

Breathing hose with flame retardant cover - protection from sparks and spatter

Control of air supply to upper or lower part of helmet

Integrated air system

Large controls
• Easy to use with oversized gloves



40040

Vibration and **Audible Filter Alarms** - filters changing / low battery



TRANSLIGHT™
SERIES

Unit contains battery charger, battery, waist belt, hose, HEPA Filter, Pre-Filter and PAPR welding helmet with ADF (odour removing filter sold separately)

**TRANSLIGHT™
SERIES**

- **Ultra slim True Color ADF**
- **Optical Classes 1/1/1/1**
- Switching speed 0.25 ms
- 110 x 90 mm cartridge size, 98 x 62 mm viewing area
- Shade range 3/5-8/9-14, sensitivity and delay adjustment, grinding mode
- ADF warranty: 3 years

B rated impact resistance

**370™
SPEED DIAL**

Features Jackson Safety® Speed Dial headgear

4 sensor technology

- Outer lens - 1.5 mm thickness
- Greater **impact resistance**
- Greater **heat resistance** with high amp work

External grind button for quick changes between modes



TH3

IP 5 4

EN 12941 TH3 P R SL

CE 0082

More details about the Translight 355 welding helmet on pages 50/51.



> 5 Amp

AIRMAX+ with TRANSLIGHT 355 PAPR SYSTEM

Product No	Description	Pack Qty
40040	AIRMAX+ PAPR with Translight 355 Welding Helmet	1

SPARE PARTS & ACCESSORIES

Product No	Description	Pack Qty
40341	FR Hose with cover, 105 cm	1
J5241	FR Hose cover, 105 cm	1
40381	AIRMAX+ Blower unit - 8 Speed	1
40332	HEPA PAPR filter	1
40363	PAPR charger	1
40353	Replacement 4-Cell 7.4V Battery	1
40371	Replacement Waist belt	1
40311	Replacement Pre-filters	10
40312	Odour removing filter	10
40100	Translight 355 shell with Face Seal and Airduct	1
40200	Translight 355 PAPR Face Seal	1
40391	PAPR Carrying Bag	1

Jackson Safety® PAPR Welding



AIRMAX+ with TRANSLIGHT™ FLIP 455

AIRMAX+ PAPR System with TRANSLIGHT FLIP 455 Welding Helmet

- **TH3** Particle Protection (Highest Possible Rating)
- **8 different** blower speed settings, adjustable airflow from 180 lpm to 260 lpm (**10 lpm Increment**)
- **IP 54** Certified
- **Vibration** and **Filter Alarms** to inform when filters need changing or low battery
- Comes with **HD 4 Cell Li-ion Battery 7.4V/5200mAh**. Charging time: 5 hours
- Operation time up to **10 hours** with a new filter P R SL and airflow 180 l/min
- In combination with Translight 455 welding helmet - featuring **new grip strip technology** to easily raise or lower the outer welding shell, exposing the clear **extra-large polycarbonate face shield** window for grinding operations
- Unit is CE Certified

Integrated air duct with hose connector

Breathing hose with flame retardant cover - protection from sparks and spatter

Control of air supply to upper or lower part of helmet

Integrated air system

- Large controls
- Easy to use with oversized gloves



40041

Vibration and **Audible Filter Alarms** - filters changing / low battery

TRANSLIGHT™
SERIES

Unit contains battery charger, battery, waist belt, hose, HEPA Filter, Pre-Filter and PAPR welding helmet with ADF (odour removing filter sold separately)

**TRANSLIGHT™
SERIES**

- **True Color ADF**
- **Optical Classes 1/1/1/1**
- **Excellent switching speed 0.1 ms**
- 110 x 90 mm cartridge size, 98 x 62 mm viewing area
- Shade range 4/5-8/9-13, sensitivity and delay adjustment, grinding mode
- ADF warranty: 3 years

Flip-Up/Flip-Down ADF module

Features Jackson Safety® Speed Dial headgear



- Outer lens - 1.5 mm thickness
- Greater **impact resistance**
- Greater **heat resistance** with high amp work

4 sensor technology

Extra-large face shield 205 x 155 mm

- **250 sq cm viewing area**
- Superior peripheral vision
- Flip-up for grinding, flip down for welding

B rated impact resistance



TH3

IP 5 4

EN 12941 TH3 P R SL

More details about the Translight Flip 455 welding helmet on pages 52/53.



> 5 Amp



AIRMAX+ with TRANSLIGHT FLIP 455 PAPR SYSTEM

Product No	Description	Pack Qty
40041	AIRMAX+ PAPR with Translight Flip 455 Welding Helmet	1

SPARE PARTS & ACCESSORIES

Product No	Description	Pack Qty
40341	FR Hose with cover, 105 cm	1
J5241	FR Hose cover, 105 cm	1
40381	AIRMAX+ Blower unit - 8 Speed	1
40332	HEPA PAPR filter	1
40363	PAPR charger	1
40353	Replacement 4-Cell 7.4V Battery	1
40371	Replacement Waist belt	1
40311	Replacement Pre-filters	10
40312	Odour removing filter	10
40101	Translight Flip 455 shell with Face Seal and Airduct	1
40201	Translight Flip 455 PAPR Face Seal	1
40391	PAPR Carrying Bag	1

Jackson Safety® PAPR Welding

AIRMAX® with TRANSLIGHT™ + 555

AIRMAX+ PAPR System with TRANSLIGHT+ 555 Welding Helmet

- **TH3** Particle Protection (Highest Possible Rating)
- **8 different** blower speed settings, adjustable airflow from 180 lpm to 260 lpm (**10 lpm Increment**)
- **IP 54** Certified
- **Vibration** and **Filter Alarms** to inform when filters need changing or low battery
- Comes with **HD 4 Cell Li-ion Battery 7.4V/5200mAh**. Charging time: 5 hours
- Operation time up to **10 hours** with a new filter P R SL and airflow 180 l/min
- In combination with Translight 555 welding helmet - featuring **extra large 98 x 82 mm viewing area** and **innovative external adjuster**
- Unit is CE Certified

Integrated air duct with hose connector

Breathing hose with flame retardant cover - protection from sparks and spatter

Control of air supply to upper or lower part of helmet



Extra large viewing area 98 x 82 mm

- Large controls
- Easy to use with oversized gloves

Vibration and Audible Filter Alarms - filters changing / low battery

TRANSLIGHT™
SERIES

Unit contains battery charger, battery, waist belt, hose, HEPA Filter, Pre-Filter and PAPR welding helmet with ADF (odour removing filter sold separately)

- **True Color ADF**
- **Optical Classes 1/1/1/1**
- Switching speed 0.2 ms
- 114 x 133 mm cartridge size, 98 x 82 mm viewing area
- Shade range 3/5-8/9-14, sensitivity and delay adjustment, grinding mode
- ADF warranty: 3 years

B rated impact resistance

Features Jackson Safety® Speed Dial headgear

TRANSLIGHT™ SERIES



- Convenient external shade adjuster
- Digital innovation
- Micro Adjust to eye and environment conditions
- Finest tunes shades +/-, full shade with 2 shade adjusting increments

- Outer lens - 1.5 mm thickness
- Greater **impact resistance**
- Greater **heat resistance** with high amp work

Extra large viewing area 98 x 82 mm

External grind mode

4 sensor technology

TH3

IP 5 4

EN 12941 TH3 P R SL

CE 0082

More details about the Translight+ 555 welding helmet on pages 54/55.



> 5 Amp

AIRMAX+ with TRANSLIGHT+ 555 PLUS PAPR SYSTEM

Product No	Description	Pack Qty
40043	AIRMAX+ PAPR with Translight+ 555 Welding Helmet	1

SPARE PARTS & ACCESSORIES

Product No	Description	Pack Qty
40341	FR Hose with cover, 105 cm	1
J5241	FR Hose cover, 105 cm	1
40381	AIRMAX+ Blower unit - 8 Speed	1
40332	HEPA PAPR filter	1
40363	PAPR charger	1
40353	Replacement 4-Cell 7.4V Battery	1
40371	Replacement Waist belt	1
40311	Replacement Pre-filters	10
40312	Odour removing filter	10
40103	Translight+ shell with Face Seal and Airduct	1
40203	Translight+ PAPR Face Seal	1
40391	PAPR Carrying Bag	1

Ultimate respiratory protection with highest protection factor

Jackson Safety® PAPR Welding



AIRMAX® ELITE with WH70

AIRMAX Elite PAPR System with WH70 PAPR Welding Helmet

The welding community is fully aware that welding fumes are carcinogenic. Our PAPR system achieves the best in class respiratory protection with TH3 rating. Our welding helmet offers best possible optical ratings of 1/1/1/1 and comfort. An almost unbeatable system. When welders are confident that their PPE is designed with their health and safety in mind they can concentrate on the job at hand, achieving maximum productivity.

- Simple control with only one button
- Operation time up to 10 hours with a new filter P R SL and airflow 160 l/min
- Adjustable airflow 160 lpm and 210 lpm
- Constant flow regardless of battery level
- Audiovisual and vibrating alarm indicating low airflow and low battery charge
- Ergonomic shape and low weight - only 980 g
- Slim profile of the unit - only 65 mm





POSSIBLE UPGRADES

- Hard hat combination
- Flip front option for grinding (110 x 90 mm clear grinding glass with shade 10 mineral glass optional)
- Magnifying lenses 107 x 51 mm (1.0, 1.25, 1.5, 1.75, 2.0, 2.5)



More details about the WH70 on pages 56/57.

TH3

EN 12941 TH3 P R SL

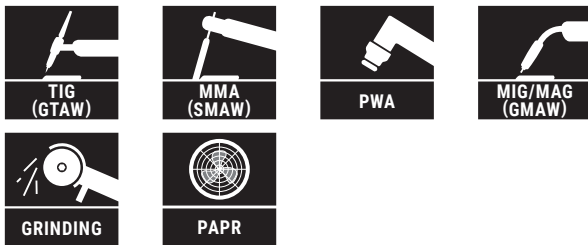

R60 AIRMAX Elite PAPR System

Product No	Description	Pack Qty
J5205	R60 Airmax Elite PAPR system	1

SPARE PARTS & ACCESSORIES

Product No	Description	Pack Qty
J5223	Exchangeable battery	1
J5254	Comfort padded belt	1
J5255	Light flexi hose	1
J5256	Battery charger	1
J5258	Chemical filter A1 P R SL	2
J5264	Chemical filter A1B1E1 P R SL + ozone	2
J5257	Particle filters P R SL	6
J5259	Pre-filter	10
J5262	Spark arrester	2

WH70 PAPR Welding Helmet

Product No	Description	Pack Qty
J5225	WH70 BH3 AIR PAPR Grand GDS	1
J5227	WH70 BH3 AIR PAPR Grand ES	1
J5226	WH70 BH3 AIR PAPR Grand DS	1
J5224	WH70 BH3 AIR PAPR for INT ADF	1
J5229	WH70 BH3 AIR PAPR for EXT ADF	1

SPARE PARTS & ACCESSORIES

Product No	Description	Pack Qty
J5233	Concept hard hat	1
J5234	Hard hat adaptor set	1
J5243	Hard hat sweat band	2
J9940	Flip front kit 110 x 90 mm	1
J9941	Flip front kit 108 x 51 mm	1
J8570	375 head gear	1
J5237	375 sweat band	1
J9931	Outer lens 147 x 125mm	10
J9932	Inner lens 107.5 x 71.5mm	10
J9934	Washer set	1
J9936	Mag lens holder	1
J9942	Leather neck protection	1
J9933	Flexi face seal	1
J5238	Standard face seal	1
J9935	Hose holder	1
40391	PAPR Carrying Bag	1

Jackson Safety® PAPR Face Shields



AIRMAX®+ with F50

AIRMAX+ PAPR System with F50 Face Shield

- **TH3** Particle Protection (Highest Possible Rating)
- **8 different** blower speed settings, adjustable airflow from 180 lpm to 260 lpm (**10 lpm Increment**)
- **IP 54** Certified
- **Vibration** and **Filter Alarms** to inform when filters need changing or low battery
- Comes with **HD 4 Cell Li-ion Battery 7.4V/5200mAh**. Charging time: 5 hours
- Operation time up to **10 hours** with a new filter P R SL and airflow 180 l/min
- In combination with F50 face shield
- Unit is CE Certified

- **Grinding**
- **Industrial tasks**



Unit contains battery charger, battery, waist belt, hose, HEPA Filter, Pre-Filter and PAPR welding helmet with ADF (odour removing filter sold separately)

Respiratory protection during grinding and other industrial tasks where the wearer is exposed to contamination from solid and liquid particles

Adjustable ergonomic headgear with airduct

Breathing hose with flame retardant cover - protection from sparks and spatter

Fitted with an **impact rated** grinding visor

- Large controls
- Easy to use with oversized gloves

Large viewing area
225 x 144 mm

Vibration and Audible Filter Alarms - filters changing / low battery



TH3

IP 5 4

CE 0082

EN 12941 TH3 P R SL



AIRMAX+ with F50 FACE SHIELD PAPR SYSTEM

Product No	Description	Pack Qty
J7265	AIRMAX+ with F50 Face Shield	1

SPARE PARTS & ACCESSORIES

Product No	Description	Pack Qty
40340	FR Hose with cover, 85 cm	1
J5241	FR Hose cover, 105 cm	1
40381	AIRMAX+ Blower unit - 8 Speed	1
40332	HEPA PAPR filter	1
40363	PAPR charger	1
40353	Replacement 4-Cell 7.4V Battery	1
40371	Replacement FR Waist belt	1
40311	Replacement Pre-filters	10
40312	Odor removing filter	10
J7261	F50 PAPR Face Shield	1
J5252	F50 Visor Lens	20
J7260	F50 PAPR Head Gear	5
J5462	PAPR Sweat Band	50
J5251	F50 PAPR Face Seal	5

Jackson Safety® PAPR Soft Hood



AIRMAX®+ with SOFT HOOD

AIRMAX+ PAPR System with Soft Hood

- **TH3** Particle Protection (Highest Possible Rating)
- **8 different** blower speed settings, adjustable airflow from 180 lpm to 260 lpm (**10 lpm Increment**)
- **IP 54** Certified
- **Vibration** and **Filter Alarms** to inform when filters need changing or low battery
- Comes with **HD 4 Cell Li-ion Battery 7.4V/5200mAh**. Charging time: 5 hours
- Operation time up to **10 hours** with a new filter P R SL and airflow 180 l/min
- In combination with soft hood - **medical use, painting and spraying**
- Unit is CE Certified

- **Medical use**
- **Painting**
- **Spraying**



**AVAILABLE
IN BLACK COLOR**



Unit contains battery charger, battery, waist belt, hose, HEPA Filter, Pre-Filter and soft hood (odour removing filter sold separately)

DISPOSABLE SOFT HOOD
ALSO AVAILABLE





- Extremely light weight
- Maximum comfort
- Positive pressure system reduces user fatigue
- Superior protection

- Fitted with an **impact rated** polycarbonate visor
- Clear vision
- Protection from Aerosol Generated Particulate and splash protection

The hood **does not require a face fit**; therefore, complexity of fitting is reduced, which is **highly desirable in Pandemic situations**

It is **suitable for all face shapes** including people with facial hair, making the system extremely versatile

- The hood is manufactured from **tough washable materials** which:
 - allows a **full clean down after use**
 - or it may be **disposed of in clinical waste**

- Large controls
- Easy to use with oversized gloves

Vibration and Audible Filter Alarms - filters changing / low battery



TH3

IP 54

CE 0082

EN 12941 TH3 P R SL

AIRMAX+ with SOFT HOOD PAPR SYSTEM

Product No	Description	Pack Qty
40070	AIRMAX+ with Soft Hood, white	1
40071	AIRMAX+ with Soft Hood, black	1

SPARE PARTS & ACCESSORIES

Product No	Description	Pack Qty
40340	FR Hose with cover, 85 cm	1
J7064	Hose without cover, 85 cm	1
J5241	FR Hose cover, 105 cm	1
40381	AIRMAX+ Blower unit - 8 Speed	1
40332	HEPA PAPR filter	1
40363	PAPR charger	1
40353	Replacement 4-Cell 7.4V Battery	1
40371	Replacement FR Waist belt	1
40372	Washable belt	1
40311	Replacement Pre-filters	10
40312	Odor removing filter	10
40170	Replacement soft hood, reusable, white	1
40171	Replacement soft hood, reusable, black	1
40175	Disposable soft hood, white	5
J7060	Sweat band	2

WELDING PROTECTION PPE



WELDING HELMETS AND WELDING FILTERS

Designed to perform in a range of welding conditions, Jackson Safety® Helmets are available in a variety of styles and features.

Choose from a selection of filters – from **passive** to **digital ADF** platforms and numerous graphic designs to reflect personal style.

PASSIVE VS. AUTO-DARKENING FILTER HELMETS

Passive helmets offer great protection.

Auto-Darkening Filters offer protection and productivity.

Both passive and Auto-Darkening Filter (ADF) welding helmets provide excellent eye protection. Research shows that ADF helmets also offer impressive productivity gains, as well as greater user comfort.

ADDED BENEFITS OF AN ADF

- **Increased accuracy**

Because the welder can always see what he's doing, and start in exactly the right spot.

- **Increased comfort**

By eliminating the repetitive "lifting and nodding" that can cause neck strain.

- **Increased protection**

From injuries caused by welding, chipping or grinding in the proximate area.

- **Increased peace of mind**

Because even if the ADF should not become active during an arc, it still protects eyes from serious damage.

- **Increased productivity**

By eliminating the time it takes to lift and nod the helmet before and after each weld.

Welders at all experience levels know the value and essential protection requirements of the right helmet and filter for the right job. That's why we provide a range of welding helmets and filters with features that are just right for you.

True Color ADF

JACKSON SAFETY[®] auto-darkening filters with 1/1/1/1 optical classification provide:

- **A clear view from various angles**

Which can reduce eye fatigue (the need to move, adjust and refocus).

- **Superior optical quality**

Allows you to do your most creative and productive work.

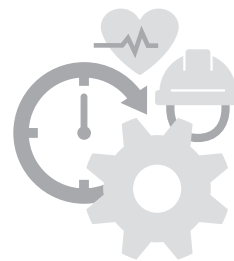

HEALTH
SAFETY

PRODUCTIVITY

Finding a better way

WELDING HEADTOPS



NEW
WH05
FLIP



NEW
WH25
DUO



NEW
REBEL

GOOD

● ● ●
WH10
FLIP UP



● ● ●
WH20
ASPIRE



BETTER

● ● ●
WH30
ALBATROSS



● ● ●
WH40
ADVANTAGE



CHOOSE YOUR HEADTOP	WH05 FLIP	WH10 FLIP UP	WH20 ASPIRE	WH25 DUO	WH30 ALBATROSS	REBEL	
Moderate Welding	●	●	●	●	●	●	
Professional Welding							
Light Grinding				●			
Heavy Grinding							



NEW

**TRANSLIGHT
355**



NEW

**TRANSLIGHT FLIP
455**



NEW

**TRANSLIGHT FLIP
455 Hard Hat**



NEW

**TRANSLIGHT+
555**



BEST



**WH50
MULTIVIEW**



WH70



	TRANSLIGHT 355	WH40 ADVANTAGE	TRANSLIGHT FLIP 455	TRANSLIGHT FLIP 455 HARD HAT	WH50 MULTIVIEW	TRANSLIGHT+ 555	WH70
	●	●	●	●	●	●	●
		●	●	●	●	●	●
	●		●	●		●	●
			●	●			●

NEW

Welding Helmets

JACKSON[®]
SAFETY

Value helmet
for preparation
and welding

Jackson Safety® Welding Helmets



WH05 FLIP

WH05 FLIP Welding Helmet with mineral glass Shade 11 Filter

- Integrated flip-up lid with a quick release system for mineral glass and compatible with ADF
- Flip up sizes 110 x 90 mm / 108 x 51 mm / 110 x 60 mm
- Comes with Shade 11 mineral glass



J7188

A / Une / Eine / Una / La



Brand / Marque / Marke / Marca

- Integrated flip-up lid with a quick release system
- Mineral glass Shade 11 Filter
- Compatible with SOLERA II ADFs
- 46440, 46470, 46480
(for models 46470, 46480 additional ADF adapter is necessary - special order J7199, J7197)



TECHNICAL DATA

Viewing Area	110 x 90 mm / 108 x 51 mm / 110 x 60 mm
Hard Hat Option	no
Weight	464 g / 420 g / 431 g
Passive Lens Shade	11

WH05 FLIP

Product No	Description	Pack Qty
J7187	WH05 FLIP Welding Helmet 110 x 60 mm, black	20
J7188	WH05 FLIP Welding Helmet 110 x 90 mm, black	20
J7189	WH05 FLIP Welding Helmet 108 x 51 mm, black	20

SPARE PARTS & ACCESSORIES

Product No	Description	Pack Qty
J7179	WH05 FLIP Inside Cover Lens	10
J7165	WH05 FLIP Protective Lens 110 x 60 mm Cover Lens	10
J7166	WH05 FLIP Protective Lens 108 x 51 mm Cover Lens	10
J7167	WH05 FLIP Protective Lens 110 x 90 mm Cover Lens	10

JACKSON®

SAFETY

Welding Helmets





WH10 FLIP UP

WH10 FLIP UP Welding Helmet with mineral glass Shade 10 Filter

- Integrated flip-up lid with a quick release system for welding filter and protective lenses

Quick release system •
Mineral glass Shade 10 Filter •



J8070



TECHNICAL DATA

Viewing Area	110 x 60 mm
Weight	410 g
Passive Lens Shade	10

WH10 FLIP UP

Product No	Description	Pack Qty
J8070	WH10 FLIP-UP Welding Helmet with Mineral Glass Shade 10	1

SPARE PARTS & ACCESSORIES

Product No	Description	Pack Qty
J8342	Flip up lid 110 x 60 mm	10
J8348	Outer lens 110 x 60 mm	100
J8356	WF10 Mineral glass 110 x 60 mm Shade 9 Filter	200
J8347	WF10 Mineral glass 110 x 60 mm Shade 10 Filter	200
J8357	WF10 Mineral glass 110 x 60 mm Shade 11 Filter	200
J8359	WF10 Mineral glass 110 x 60 mm Shade 12 Filter	200
J5233	Hard Hat Concept	1

JACKSON[®]
SAFETY

A helmet that will
aspire you

Jackson Safety[®] Welding Helmets



WH20 ASPIRE[®]

WH20 ASPIRE Welding Helmet
with 4/9-13 ADF

- 110 x 90 mm cartridge size, 97 x 42 mm viewing area
- Shade range 9-13
- Shade selection, sensitivity and delay adjustment
- External shade adjustment
- Total weight 510 g (ADF included)



J8049



External shade adjustment

- Shade range 9-13 (external control), sensitivity and delay adjustment (internal)
- 110 x 90 mm cartridge size, 97 x 42 mm viewing area



Adjustable ergonomic headgear



> 50 Amp



TECHNICAL DATA

Viewing Area	97 x 42 mm
Optical Clarity	1/2/1/3
Weight	495 g
Open State Shade	4
Closed State Shade	9-13
Shade Adjustment	yes / external
Sensitivity Adjustment	yes / internal
Delay Adjustment	yes / internal
Grinding Mode	no
Switching Time	0.3 ms
Energy Supply	solar cells / no battery change

WH20 ASPIRE

Product No	Description	Case Qty
J8049	WH20 ASPIRE Welding Helmet with WF20 4/9-13 EXT ADF	6

SPARE PARTS & ACCESSORIES

Product No	Description	Case Qty
J8370	Head gear with sweatband	1
J8319	Outer lens 115 x 104 mm	100
J8302	Inner lens 107 x 51 mm	100

NEW

Welding Helmets

JACKSON[®]
SAFETY

Protect your
eyes

Jackson Safety[®] Welding Helmets



WH25 DUO

WH25 DUO Welding Helmet with 4/9-13 ADF
for welding and grinding

- Optical classes 1/1/1/2
- AIRMAX PAPR compatible
- 110 x 90 mm cartridge size, 92 x 41 mm viewing area
- Shade range 9-13, sensitivity and delay adjustment, grinding mode
- Total weight 498 g (ADF included)



J7101

A / Une / Eine / Una / La



Brand / Marque / Marke / Marca

Ordering E-mail sales@jacksonsafety.eu

Customer Service +386 1 477 67 84

www.jacksonsafety.eu



- ADF Optical Classes 1/1/1/2
- 110 x 90 mm cartridge size, 92 x 41 mm viewing area
- Shade range 9-13, sensitivity and delay adjustment, grinding mode
- ADF warranty: 1 year

- External shade adjustment
- Positive click mode to grind

TECHNICAL DATA

Viewing Area	92 x 41 mm
Optical Clarity	1/1/1/2
Hard Hat Option	no
Weight	498 g
Open State Shade	4
Closed State Shade	9-13
Shade Adjustment	yes / external
Sensitivity Adjustment	yes / internal
Delay Adjustment	yes / internal
Grinding Mode	yes
Switching Time	0.3 ms
Energy Supply	solar cells / non replaceable 3V Li-ion batteries



Combinable with AIRMAX®



> 20 Amp



WH25 DUO / WH25 DUO PAPR

Product No	Description	Pack Qty
J7101	WH25 DUO Welding Helmet with 4/9-13 ADF	1
J7051	WH25 DUO PAPR Welding Helmet with 4/9-13 ADF	1

SPARE PARTS & ACCESSORIES

Product No	Description	Pack Qty
J7176	WH25 DUO Front Cover Lens	10
J7177	WH25 DUO Inner Cover Lens	10
J7172	WH25 DUO ADF Cradle	1
J7173	WH25 DUO Welding - Lens Retainer	1
J7910	WH25 DUO Weld Helm Spacer Kit	1
J7174	WH25 DUO Welding Head Gear Pro	1
J7175	WH25 DUO Sweat Band Pro	2
J7180	DUO ADF 4/9-13	1
J7061	WH25 DUO PAPR Faceseal	1
J7060	WH25 DUO PAPR Sweatband	2
J7062	WH25 DUO PAPR Head Gear	1



Heavy duty performer

Jackson Safety® Welding Helmets



WH30 ALBATROSS

WH30 ALBATROSS welding/grinding helmet for most demanding tasks

- Combined welding and grinding solution
- Supplied with Shade 10 mineral glass filter (ADF available as extra if required)
- Tough design for demanding tasks
- B rated impact resistance for grinding
- Flip helmet allows user to easily convert from welding mode (down position) to grind mode (up position)
- Large clear window in grind mode



J5032



TECHNICAL DATA

Filter Lens	J8102
Viewing Area	110 x 90 mm
Weight	592 g
Passive Lens Shade	10



WH30 ALBATROSS

Product No	Description	Pack Qty
J5032	WH30 ALBATROSS Welding Helmet with Mineral Glass Shade 10	1

SPARE PARTS & ACCESSORIES

Product No	Description	Case Qty
J8333	PRO head gear	5
J8304	Inner lens 110 x 90 mm	100
J8302	Inner lens 107 x 51 mm	100
J8354	Outer lens 107 x 87 mm	100
J8346	Lens retainer for passive filter black	50
J8353	Welding visor clear	10

JACKSON[®]

SAFETY

All in oneJackson Safety[®] Welding Helmets

WH40 ADVANTAGE

WH40 ADVANTAGE welding helmet offers you to choose your own elements

- Classic style available with or without ADF and choice of ADF options
- Colour options available: silver and blue
- 1/1/1/2 optical clarity



J8010



J8034

• Two colors available

• Silver

• Blue

• Optional External Shade Adjustment



TECHNICAL DATA	EXT ADF	INT ADF
	<i>blue, silver</i>	<i>blue</i>
Filter Lens	J8190	J8187
Viewing Area	96 x 42 mm	
Optical Clarity	1/1/1/2	
Weight	550 g	520 g
Open State Shade	4	
Closed State Shade	9-13	
Shade Adjustment	yes / external	yes / internal
Sensitivity Adjustment	yes / internal	
Delay Adjustment	yes / internal	
Grinding Mode	no	
Switching Time	0.3 ms	
Energy Supply	solar cells + 2x Li-ion battery	

WH40 ADVANTAGE

Product No	Description	Pack Qty
J8019	WH40 ADVANTAGE Welding Helmet with WF40 4/9-13 TN EXT ADF, blue	1
J8034	WH40 ADVANTAGE Welding Helmet with WF40 4/9-13 TN EXT ADF, silver	1
J8010	WH40 ADVANTAGE Welding Helmet with WF40 4/9-13 TN INT ADF, blue	1
J8011	WH40 ADVANTAGE Welding Helmet for INT (w/o ADF), blue	1
J8016	WH40 ADVANTAGE Welding Helmet for INT (w/o ADF), silver	1

SPARE PARTS & ACCESSORIES

Product No	Description	Pack Qty
J8333	PRO head gear	5
J8328	Inner lens 103.5 x 47 mm	100
J8302	Inner lens 107 x 51 mm	100
J8301	Outer lens 110 x 97 mm	100
J8362	Replacement Front Bezel Plate - Black	50
J8361	Replacement Front Bezel Plate - Silver	50
J8162	WF40 SM INT 4/9-12 ADF	1
J8187	WF40 TN INT 4/9-13 ADF	1
J8190	WF40 TN EXT 4/9-13 ADF	1

Expand your horizons

Jackson Safety® Welding Helmets



WH50 MULTIVIEW

Welding helmet with side windows for increased awareness during the welding task

- IRUV Shade 5 side windows for lateral vision
- Fitted with easy-to-adjust ratcheting Pro headgear mechanism
- High quality carbon graphite graphics
- Designed to accommodate disposable respirator underneath helmet



J8024

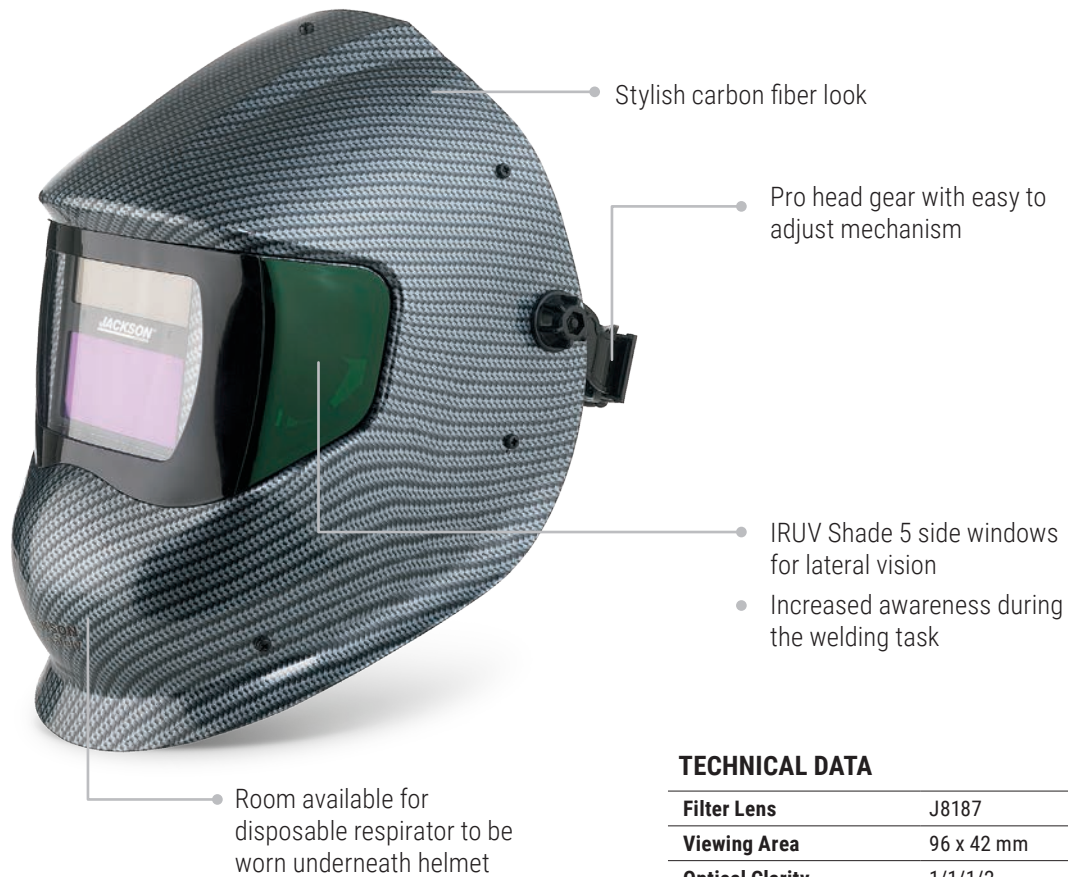

TECHNICAL DATA

Filter Lens	J8187
Viewing Area	96 x 42 mm
Optical Clarity	1/1/1/2
Weight	515 g
Open State Shade	4
Closed State Shade	9-13
Shade Adjustment	yes / internal
Sensitivity Adjustment	yes / internal
Delay Adjustment	yes / internal
Grinding Mode	no
Switching Time	0.2 ms
Energy Supply	solar cells + 1x battery



WH50 MULTIVIEW

Product No	Description	Pack Qty
J8024	WH50 MULTIVIEW IR/UV5 Welding Helmet with WF50 4/9-13 TN INT ADF	1
J8003	WH50 MULTIVIEW IR/UV5 Replacement shell for INT ADF	1

SPARE PARTS & ACCESSORIES

Product No	Description	Pack Qty
J8333	PRO head gear	5
J8303	Inner lens 109 x 66 mm	100
J8327	Inner lens 104 x 53 mm	100
J8338	Outer lens 142.4 x 89.2 mm	100
J8358	WH50 Multiview Side windows RL	20
J8172	WF50 SM INT 4/9-12 ADF	1
J8191	WF50 TN INT 4/9-13 ADF	1

NEW

ADF Welding/Goggle Mask

JACKSON[®]
SAFETY



Jackson Safety[®] ADF Welding Mask



REBEL™

ADF Welding/Goggle Mask - Digital

The all new, exclusive Jackson Safety[®] Rebel™ welding mask is a great addition to our welding program, incorporating modern ADF technology. The Rebel™ is a lightweight product designed to reduce neck strain. In addition, the Rebel is designed to fit under most hard hats without the need for adaptor brackets, making it extremely versatile.

- New Rebel ADF masks are an ideal product for intermittent welding applications such as: automotive, fleet and agricultural equipment repairs; DIY projects; general shop applications
- Constructed with the goggle / face shield as a one piece integrated unit; eliminating spark & spatter risks to front of face
- The Rebel's soft, comfortable goggle body conforms very well to face contours, reducing UV/IR ray leakage concerns
- Specially designed to fit over most prescription eyewear – no cheater magnifying lens needed!
- Features a replaceable clear outer lens for added ADF protection (46930–5 pack)
- No adapters needed to use with hard hats
- Low TIG amp rated >10 amps
- Solar panel recharges CR 2450 replaceable battery – each battery lasts up to 1,300 hours before replacement is necessary



A / Une / Eine / Una / La

 **SureWerx**[™]

Brand / Marque / Marke / Marca



TECHNICAL DATA

REBEL

Viewing Area	90 x 35 mm
Optical Clarity	1/1/1/2
True Color	Yes
Weight	250 g
Open State Shade	3
Closed State Shade	5-12
Button Controls	digital
Shade Adjustment	yes / external
Sensitivity Adjustment	yes / external
Delay Adjustment	yes / external
Grinding Mode	yes / external
Switching Time	0.1 ms
Energy Supply	Solar cells & Lithium (CR2450) Batteries



> 10 Amp



Product No	Description	Case Qty
46200	Rebel ADF Welding Mask & FR Hood (kit)	6

SPARE PARTS & ACCESSORIES

Product No	Description	Case Qty
46600	Rebel Replacement FR Hood	10
46930	Rebel Replacement Lens Kit, 5 External, 2 Internal	100

NEW

Welding Helmets



Jackson Safety® Welding Helmets



TRANSLIGHT™ 355

TRANSLIGHT™ 355 Premium Auto Darkening Welding Helmet

- Translight 355 Series is super-lightweight with a sleek, modern design and look
- Auto Darkening Filter meets **1/1/1/1 Optical Clarity Standard**, the highest in the industry
- ADF contains external grind button for quick changes between modes
- Welding, Grinding, Cutting modes included
- Includes patented **370 Speed Dial** ratcheting headgear system
- Switching speeds of 0.25 ms
- Solar & Lithium Batteries (CR2032)
- 4 sensor technology for optimal performance
- Outer lens at 1.5 mm thickness

TRANSLIGHT™
SERIES

EXCLUSIVE!



46230

A / Une / Eine / Una / La

 **SureWerx™**

Brand / Marque / Marke / Marca

Ordering E-mail sales@jacksonsafety.eu

Customer Service +386 1 477 67 84

www.jacksonsafety.eu

**TRANSLIGHT™
SERIES**



Features Jackson Safety® premium 370 Series **Easy Grip-Easy Turn** ratcheting mechanism—**AN INDUSTRY BEST!**



- **Ultra slim True Color ADF**
- **Optical Classes 1/1/1/1**
- Switching speed 0.25 ms
- 110 x 90 mm cartridge size, 98 x 62 mm viewing area
- Shade range 3/5-8/9-14, sensitivity and delay adjustment, grinding mode
- ADF warranty: 3 years



Combinable with AIRMAX+



> 5 Amp



TECHNICAL DATA TRANSLIGHT 355

Viewing Area	98 x 62 mm
Optical Clarity	1/1/1/1
True Color	Yes
Weight	521 g
Open State Shade	3
Closed State Shade	5-14
Button Controls	digital/analogue
Shade Adjustment	yes / internal
Sensitivity Adjustment	yes / internal
Delay Adjustment	yes / internal
Grinding Mode	yes / external
Switching Time	0.25 ms
Energy Supply	Solar & Lithium (CR2032) Batteries

TRANSLIGHT 355

Product No	Description	Pack Qty
46230	TRANSLIGHT 355 Welding Helmet with ADF, black	1

SPARE PARTS & ACCESSORIES

Product No	Description	Pack Qty
46432	Translight 355 Replacement ADF	1
46913	Translight 355 Internal Safety Plates (Pack of 10)	10
46923	Translight 355/455 External Safety Plates (Pack of 10)	10
20693	Translight Replacement 370 Headgear	1
46993	Translight 355 Lens retainer	1

NEW

Welding Helmets

JACKSON[®]
SAFETY



Jackson Safety® Welding Helmets



TRANSLIGHT™ FLIP 455

TRANSLIGHT™ Flip 455 Auto Darkening
Welding Helmet

- Translight™ Flip 455 helmet comes with **new grip strip technology** to easily raise or lower the outer welding shell, exposing the clear extra-large polycarbonate face shield window for grinding operations
- Flip system ensures maximum safety – provides uninterrupted face protection when switching from welding to grinding operations
- High quality **True Color ADF** provides a full **60 square cm** viewing area
- Features an extra-large face shield which provides superior peripheral vision
- Welding, grinding, cutting modes functions are standard features
- 4 sensor technology for optimal performance
- Auto-darkening filter meets **1/1/1/1 optical clarity** standard, the highest in the industry
- Includes patented **370 Speed Dial** ratcheting headgear system
- Switching speeds of 0.1 ms

TRANSLIGHT™
SERIES

Jackson Safety setting NEW standards for
flip welding helmet design & comfort

EXCLUSIVE!



46240

Available option with hard hat:

**TRANSLIGHT FLIP 455
HARD HAT**



46241

A / Une / Eine / Una / La

 **SureWerx™**

Brand / Marque / Marke / Marca

**TRANSLIGHT™
SERIES**

New, state-of-the-art sleek shell design

New grip strip technology to easily raise or lower the outer welding shell



- Outer lens - 1.5 mm thickness
- Greater **impact resistance**
- Greater **heat resistance** with high amp work
- **True Color ADF**
- **Optical Classes 1/1/1/1**
- **Excellent switching speed 0.1 ms**
- 110 x 90 mm cartridge size, 98 x 62 mm viewing area
- Shade range 4/5-8/9-13, sensitivity and delay adjustment, grinding mode
- ADF warranty: 3 years

Features Jackson Safety® premium 370 Series **Easy Grip-Easy Turn** ratcheting mechanism—
AN INDUSTRY BEST!



Extra-large face shield 205 x 155 mm

250 sq cm viewing area

- Superior peripheral vision
- Flip-up for grinding, flip down for welding

B rated impact resistance



Combinable with AIRMAX+



> 5 Amp



TECHNICAL DATA	TRANSLIGHT FLIP 455
Viewing Area	98 x 62 mm
Optical Clarity	1/1/1/1
True Color	Yes
Weight	725 g
Open State Shade	4
Closed State Shade	5-8/9-13
Button Controls	digital & analog
Shade Adjustment	yes / internal
Sensitivity Adjustment	yes / internal
Delay Adjustment	yes / internal
Grinding Mode	yes / internal
Switching Time	0.1 ms
Energy Supply	Solar & Lithium (CR2032) Batteries

TRANSLIGHT FLIP 455

Product No	Description	Pack Qty
46240	TRANSLIGHT FLIP 455 Welding Helmet with ADF, black	1
46241	TRANSLIGHT FLIP 455 Welding Helmet with Hard hat and ADF, black	1

COMING SOON

SPARE PARTS & ACCESSORIES

Product No	Description	Pack Qty
46442	Translight 455 Replacement ADF	1
46923	Translight 355/455 External Safety Plates (Pack of 10)	10
46914	Translight 455 Internal Safety Plates (Pack of 10)	10
46640	Translight Flip 455 Face Shield Replacement Window (Pack of 5)	5
46641	Translight Flip 455 Replacement Hard Hat	1
20693	Translight Replacement 370 Headgear	1
46994	Translight Flip 455 Lens retainer	1

COMING SOON

NEW

JACKSON[®]
SAFETY

Welding Helmets



Jackson Safety® Welding Helmets



TRANSLIGHT™ + 555

TRANSLIGHT™ + 555 Auto Darkening Welding Helmet

The Translight™ Series is defined philosophies by our innovative global design. We mix industry leading features with new advancements in technology to transcend the welding industry.

- Translight™ shell has a sleek modern design
- Helmet is lightweight & ergonomically balanced to reduce stress & fatigue
- Auto Darkening Filter meets **1/1/1/1 Optical Clarity** standard, the highest in the industry
- Includes an external grind button, so end users can switch modes with ease
- Features the new external shade adjuster to help aid in visual focus
- The new shade adjuster can finely tune shades up to +/- 1 full shade with .2 shade adjusting increments
- Welding, Grinding and Cutting can be done with this versatile ADF
- Includes patented **370 Speed Dial** ratcheting headgear system
- Advanced digital controls are a great QOL enhancement for welders
- Switching speeds of 0.2 ms

EXCLUSIVE!



46250

TRANSLIGHT™
SERIES

Jackson Safety setting NEW standards for
large viewing area welding helmets

**TRANSLIGHT™
SERIES**

- Outer lens - 1.5 mm thickness
- Greater **impact resistance**
- Greater **heat resistance** with high amp work

Lightweight & ergonomically balanced to reduce stress & fatigue

4 sensor technology



Features Jackson Safety® premium 370 Series **Easy Grip-Easy Turn** ratcheting mechanism—**AN INDUSTRY BEST!**



External grind mode

- Convenient external shade adjuster
- Digital innovation
- Micro Adjust to eye and environment conditions
- Finest tunes shades +/-, full shade with 2 shade adjusting increments

True Color ADF

- **Optical Classes 1/1/1/1**
- Switching speed of 0.2 ms
- 114 x 133 mm cartridge size, **extra large 98 x 82 mm viewing area**
- Shade range 3/5-8/9-14, sensitivity and delay adjustment, grinding mode
- ADF warranty: 3 years

B rated impact resistance



Combinable with AIRMAX+



> 5 Amp



TECHNICAL DATA TRANSLIGHT+ 555

Viewing Area	98 x 82 mm
Optical Clarity	1/1/1/1
True Color	yes
Weight	612 g
Open State Shade	3
Closed State Shade	5-8/9-14
Button Controls	Digital
Shade Adjustment	yes / internal
Sensitivity Adjustment	yes / internal
Delay Adjustment	yes / internal
Grinding Mode	yes / external
Switching Time	0.2 ms
Energy Supply	Solar & Lithium (CR2032) Batteries

TRANSLIGHT+ 555

Product No	Description	Pack Qty
46250	TRANSLIGHT+ 555 Welding Helmet with ADF, black	1

SPARE PARTS & ACCESSORIES

Product No	Description	Pack Qty
46452	Translight+ 555 Replacement ADF	1
46925	Translight+ 555 External Safety Plates (Pack of 10)	10
46915	Translight+ 555 Internal Safety Plates (Pack of 10)	10
46995	Translight+ 555 Replacement Retainer	1
20693	Translight Replacement 370 Headgear	1

JACKSON[®]

SAFETY

Welding Helmets

Take the art of welding to its highest level

Jackson Safety[®] Welding Helmets



WH70

Welding helmet with 1/1/1/1 optical classes and XL viewing area

- Aerodynamic design for better fume deflection and a smooth rounded perimeter for increased comfort
- Protective lenses and ADFs are easily removed to be replaced or cleaned
- Large viewing area 96 x 68.5 mm
- Lightweight, 399 g w/o ADF
- European designed
- All components made in EU
- Available with 3 different ADFs - your choice!
- A European legend!

BALDER[®]
TECHNOLOGY

370[™]
SPEED DIAL



J9916

A / Une / Eine / Una / La

 **SureWerx**[™]

Brand / Marque / Marke / Marca

- XL viewing area - 96 x 68.5 mm
- 1/1/1/1 optical classification



- Aerodynamic design for better fume deflection
- Smooth rounded perimeter for increased comfort
- Features Jackson Safety® premium **370 Speed Dial** ratcheting mechanism

BALDER
TECHNOLOGY

370
SPEED DIAL

External ADF Option

TECHNICAL DATA	GDS	ES	DS
Filter Lens	J9927	J9928	J9929
Viewing Area	96 x 68.5 mm		
Hard Hat Option	yes		
Optical Clarity	1/1/1/1		
Weight	565 g	560 g	520 g
Open State Shade	4		
Closed State Shade	6-8/9-13	9-13	9-13
Shade Adjustment	yes / ext	yes / ext	yes / int
Sensitivity Adjustment	yes / ext	yes / ext	yes / int
Delay Adjustment	yes / ext	yes / ext	yes / int
Grinding Mode	yes / ext	no	no
Switching Time	0.15 ms		
Energy Supply	solar cells + 2x Li-ion battery		



Combinable with
AIRMAX Elite



WH70

Product No	Description	Pack Qty
J9914	WH70 Welding Helmet with Grand DS ADF	1
J9915	WH70 Welding Helmet with Grand ES ADF	1
J9916	WH70 Welding Helmet with Grand GDS ADF	1
J9912	WH70 Replacement Shell for INT ADF	1
J9913	WH70 Replacement Shell for EXT ADF	1

SPARE PARTS & ACCESSORIES

Product No	Description	Pack Qty
J5233	Concept hard hat	1
J5234	Hard hat adaptor set	1
J5243	Hard hat sweat band	2
J9940	Flip front kit 110 x 90 mm	1
J9941	Flip front kit 108 x 51 mm	1
J8570	370 head gear	1
J5237	370 sweat band	1
J9931	Outer lens 147 x 125 mm	10
J9932	Inner lens 107.5 x 71.5 mm	10
J9934	Washer set	1
J9936	Mag lens holder	1
J9942	Leather neck protection	1

JACKSON[®]

SAFETY

Welding Helmets

The World's Greatest Ratcheting Headgear System

Jackson Safety[®] Headgears



370 SPEED DIAL

Headgear system

Our patented Jackson Safety[®] 370 Speed Dial[™] offers the fastest, easiest, and most efficient ratcheting headgear system in the industry today! The 370 Speed Dial[™] incorporates two unique designs—an oversized “speed dial ratcheting adjuster knob, and a patented “quick-fit” rear headband that swivels up and down. Together, these two features combine to achieve a perfect fit every time, increasing safety, productivity and satisfaction. Try any of our industry-leading Jackson Safety[®] products that incorporate our famous 370 Speed Dial[™] and experience the difference yourself!

EXCLUSIVE!

370[™]
SPEED DIAL

A / Une / Eine / Una / La

 **SureWerx**[™]

Brand / Marque / Marke / Marca

Engineered detents lock equipment in the up and down position and eliminate "creep"

Easy to adjust pin-lock upper adjustment band allows proper positioning of face shield

Three-position slider adjusts distance of the lens from your eyes for precise vision

Extra wide replaceable fabric sweatband for maximum comfort and convenience

Patented "quick-fit" rear swivel headband quickly adjusts the suspension to the user's head for superior comfort, convenience, and productivity

Lock-nut feature keeps components intact even when the bracket is loosened

"Easy Grip-Easy Turn" rotation allows instant loosening and tightening of the headgear

Oversized soft rubber adjuster dial is easy to find and grab even when wearing gloves



Fine tooth ratcheting mechanism guarantees a more precise fit without overtightening

Product No	Description	Pack Qty
J8570	370 Speed Dial Headgear - for use with Airmax Elite	1
20693	370 Speed Dial Headgear - for use with Translight series	1
20694	370 Speed Dial Headgear - for use with Quad 500	1
20695	370 Speed Dial Headgear - for use with Maxview and F4XP	1



20693



J8570

A JACKSON EXCLUSIVE!

Welding Filters

SAFETY FIRST

● CE certified

All ADFs are CE certified and most of them **exceed required protection** levels by large margin (switching speed, UV/IR protection).

● Protection against UV and IR light

ADFs are designed so that regardless of dark or clear state welder's eyes are **always protected** against harmful UV and IR light occurring during welding process.

● Excellent switching speed

Switching speed and detection of welding arc **prevent light flash** from reaching welder's eyes.

● Safe in any weld process

Variable shade level, sensitivity and delay allow for **adjusting protection** parameters to any weld process.

WIDE SELECTION OF PRODUCT PERFORMANCE LEVELS AVAILABLE



EASE OF WORK

ADFs can be adjusted to any type of welding by selecting shade level, sensitivity to welding arc and opening time delay.

Selectable operation mode (Weld/Grind/Cut) allows for permanent eye protection during the whole metal processing operation.

Increased productivity as both hands can be used.

● Simple welding tasks

Mineral glass or single shade ADFs.

●● Entry level welding tasks

Limited shade range, average speed and window size – cost effective.

●●● Professional tasks

All required features at moderate cost with added functionality.

●●●● Extremely demanding tasks

Highest optical performance, switching speed, sensitivity range and various modes of operation.

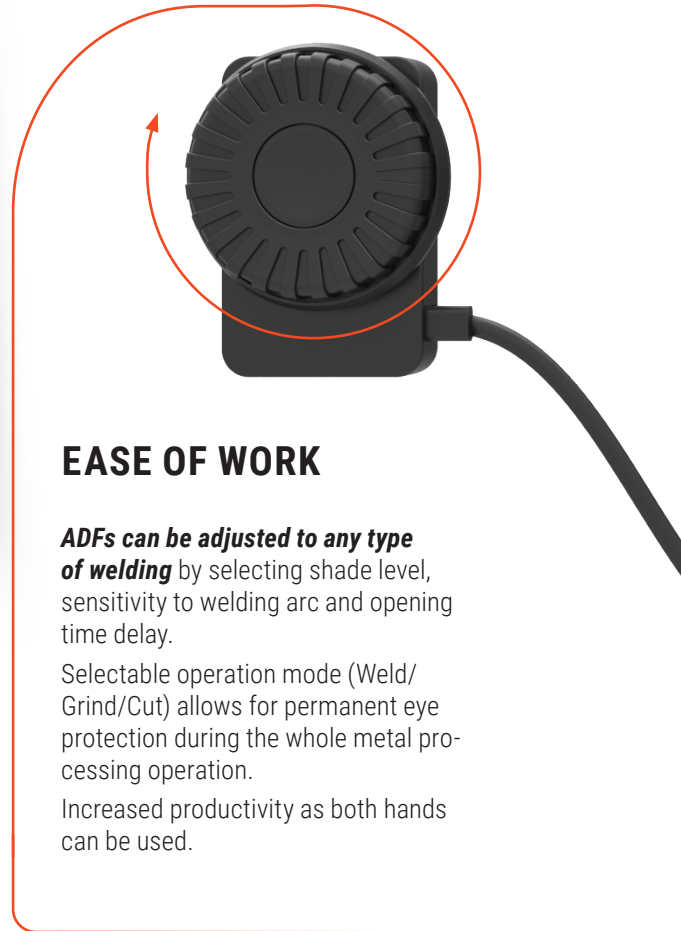

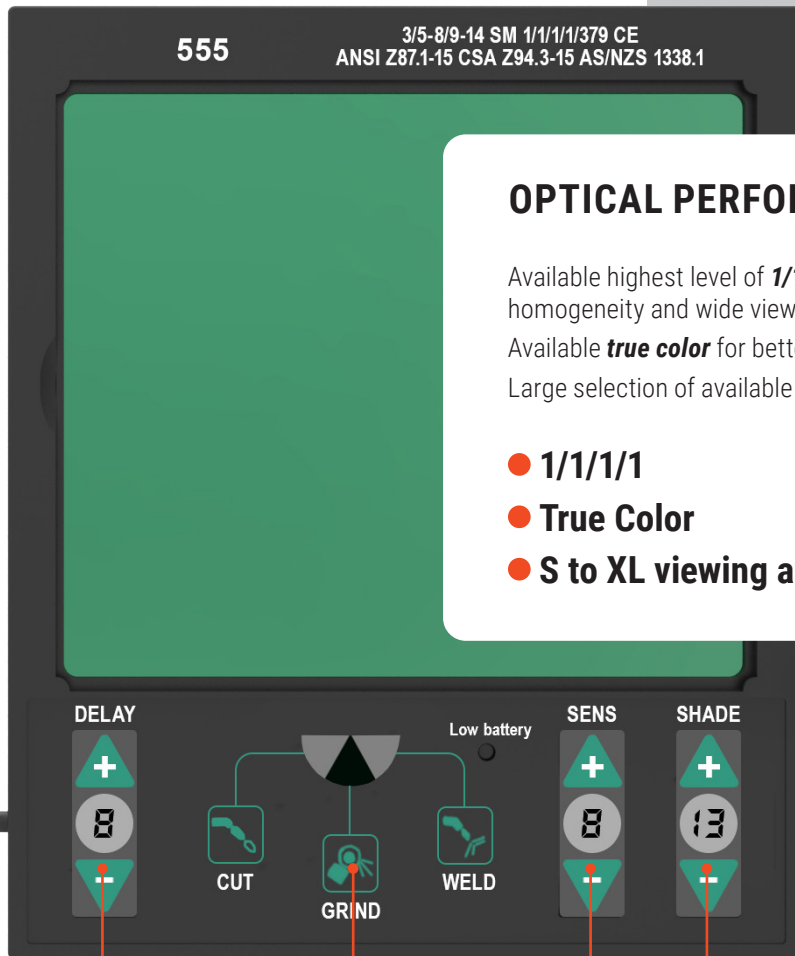

OPTICAL PERFORMANCE

Available highest level of **1/1/1/1** with highest optical clarity, homogeneity and wide viewing angle.
Available **true color** for better process control.
Large selection of available viewing area sizes from 35 to 80 cm².

- **1/1/1/1**
- **True Color**
- **S to XL viewing area**

- **Shade level**
- **Sensitivity**
- **Operation mode**
- **Opening time delay**

ADDITIONAL FEATURES

- **Highest speed ADFs**
Surface mode technology on some models.
- **ADF power source selection**
 - **Replaceable batteries** (alkaline or lithium).
 - **Fixed batteries** - No battery changes for the lifetime of the product.
 - **Solar cells** for battery life extension.
- **Low weight and ultraslim ADFs**
Reduced weight and ultraslim ADFs available.
- **Warranty**
1, 2, 3 or 5 year warranty depending on ADF model.

Jackson Safety® Welding Passive Filters



PASSIVE WELDING FILTERS - MINERAL GLASS

- Passive welding filters are made of toughened mineral glass
- Offered in two sizes: 110 x 60 mm and 110 x 90 mm
- Wide range of DIN shades 9, 10, 11, 12

Product No	Description	Case Qty
J8356	WF10 Welding Passive Filter 110 x 60 mm Shade 9	200
J8347	WF10 Welding Passive Filter 110 x 60 mm Shade 10	200
J8357	WF10 Welding Passive Filter 110 x 60 mm Shade 11	200
J8359	WF10 Welding Passive Filter 110 x 60 mm Shade 12	200
J8101	WF10 Welding Passive Filter 110 x 90 mm Shade 9	200
J8102	WF10 Welding Passive Filter 110 x 90 mm Shade 10	200
J8103	WF10 Welding Passive Filter 110 x 90 mm Shade 11	200
J8104	WF10 Welding Passive Filter 110 x 90 mm Shade 12	200



Compatible with:

- **WH05 FLIP**
- **WH10 FLIP-UP**
- **WH30 ALBATROSS**



Jackson Safety[®] Magnifying Lenses



PC MAGNIFYING LENSES

- Designed for use with welding helmet filters
- Offers reliable protection for eyes from impact whilst offering + optics
- Available in wide range of diopters: 1.0, 1.25, 1.5, 1.75, 2.0, 2.5
- Special magnifying lens holder may be required

Product No	Description	Case Qty
J2741	Magnifying Lens 1.0 Clear	6
J2742	Magnifying Lens 1.25 Clear	6
J2743	Magnifying Lens 1.5 Clear	6
J2744	Magnifying Lens 1.75 Clear	6
J2745	Magnifying Lens 2.0 Clear	6
J2747	Magnifying Lens 2.5 Clear	6



Wide range of diopters:
1.0, 1.25, 1.5, 1.75, 2.0, 2.5

Special lens holder
may be required



NEW

Jackson Safety® Welding ADFs

JACKSON[®]
SAFETY

Welding ADFs

SOLERA II

Drop in ADFs

The Solera II drop in ADFs are a cost effective way for end users to upgrade from their passive filters. These ADFs are simple to use, intuitive, and fit our Jackson WH05 Flip Helmets as well as other shells in the market with the same dimensions. Now with True Color, you can really see the difference with our Solera II drop in options.



● 110 x 90 mm ● 110 x 60 mm ● 108 x 51 mm

- Includes **True Color** for improved optical clarity
- Solera II ADFs fit our Jackson WH05 Flip Helmet
- Sleek, **ultra light** design
- **Easy to use**
- **Cost effective**
- Uses Solar & Non-replaceable Lithium (CR2032) Batteries

Pack of 10 Solera II ADFs
come with an attractive
ready-to-use
retail dispenser box



A / Une / Eine / Una / La

 **SureWorx**[™]

Brand / Marque / Marke / Marca

Ordering E-mail sales@jacksonsafety.eu

Customer Service +386 1 477 67 84

www.jacksonsafety.eu



ADFs

Welding ADFs

GOOD BETTER BEST

Filter name	NEW DUO	NEW SOLERA			NEW REBEL	NEW TRANSLIGHT		
		108 x 51	110 x 60	110 x 90		355	455	555
Product No	J7180	46470	46480	46440	46200	46432	46442	46452
Compatible shell	WH25 DUO	WH05 FLIP	WH05 FLIP	WH05 FLIP	-	TRANSLIGHT 355	TRANSLIGHT 455 FLIP	TRANSLIGHT+ 555
Outer protective lens	J7176	J7166	J7165	J7167	46930 (Lens Kit: 5 Ext., 2 Int.)	46923	46923	46925
Inner protective lens	J7177	46910	46916	46917		46913	46914	46915
Cartridge size	110 x 90 mm	108 x 51 mm	110 x 60 mm	110 x 90 mm	108 x 51 mm	110 x 90 mm	110 x 90 mm	114 x 133 mm
Viewing window	93 x 42 mm	96 x 35 mm	96 x 35 mm	92 x 42 mm	90 x 35 mm	98 x 62 mm	98 x 62 mm	98 x 82 mm
View window sq in	39 sq cm	34 sq cm	34 sq cm	39 sq cm	31 sq cm	60 sq cm	60 sq cm	80 sq cm
Shade range	4/9-13	3/11	3/11	3/11	3/5-12	3/5-8/9-14	4/5-8/9-13	3/5-8/9-14
Switching time RT	0.3 ms	0.2 ms	0.2 ms	0.2 ms	0.1 ms	0.25 ms	0.1 ms	0.2 ms
Clearing time	0.1 - 0.8 s	0.1 s	0.1 s	0.1 s	0.2 - 0.8 s	0.1 - 0.9 s	0.1 - 1.0 s	0.1 - 0.9 s
Sensors	2	2	2	2	2	4	4	4
True Color	Yes	Yes	Yes	Yes	Yes	Yes	Yes	Yes
Optical clarity	1/1/1/2	1/1/1/2	1/1/1/2	1/1/1/2	1/1/1/2	1/1/1/1	1/1/1/1	1/1/1/1

Shade adjustment	●	-	-	-	●	●	●	●
Sensitivity adjustment	●	-	-	-	●	●	●	●
Delay adjustment	●	-	-	-	●	●	●	●
Welding	●	●	●	●	●	●	●	●
Grinding	●	-	-	-	-	●	●	●
Cutting	-	-	-	-	-	●	-	●
TIG > 20 amps	●	-	-	-	●	●	●	●
TIG < 20 amps	-	-	-	-	●	●	●	●
Battery type	Lithium - Fixed	Lithium - Fixed	Lithium - Fixed	Lithium - Fixed	Lithium - Replaceable	Lithium - Replaceable	Lithium - Replaceable	Lithium - Replaceable
Solar cells	●	●	●	●	●	●	●	●
370 Speed Dial Headgear	-	-	-	-	-	●	●	●
Special Features	-	-	-	-	4.7 mm optics	Thin 3.9 mm optics	Thin 3.5 mm optics	4.9 mm optics
Warranty	1 Year	2 Years	2 Years	2 Years	2 Years	3 Years	3 Years	3 Years



ADFs

GOOD

Filter name	WF20 ES	WF20 TN INT 3/10	WF20 TN INT 3/11	WF40 SM INT 4/9-12	WF40 TN EXT 4/9-13	WF40 TN INT 4/9-13	
Product No	-	J8181	J8183	J8162	J8190	J8187	
Compatible shell	WH20 ASPIRE	WH30/40 ADVANTAGE	WH30/40 ADVANTAGE	WH30/40 ADVANTAGE	WH30/40 ADVANTAGE	WH30/40 ADVANTAGE	
Outer protective lens	J8319	J8301	J8301	J8301	J8301	J8301	
Inner protective lens	J8302	J8304	J8304	J8303	J8328	J8302	
Cartridge size	110 x 90 mm	110 x 90 mm	110 x 90 mm	110 x 90 mm	110 x 90 mm	110 x 90 mm	
Viewing window	100 x 41 mm	92 x 38 mm	97 x 41 mm	96.5 x 60 mm	96.5 x 41 mm	96.5 x 41 mm	
View window sq in	41 sq cm	35 sq cm	40 sq cm	58 sq cm	40 sq cm	40 sq cm	
Shade range	4/9-13	3/10	3/11	4/9-12	4/9-13	4/9-13	
Switching time RT	0.4 ms	0.5 ms	0.5 ms	0.04 ms	0.4 ms	0.4 ms	
Clearing time	0.2 - 0.8 s	0.2 - 0.8 s	0.4 s	0.1 - 1.0 s	0.2 - 0.8 s	0.2 - 0.8 s	
Sensors	2	2	2	2	2	2	
True Color	Yes	Yes	Yes	Yes	Yes	Yes	
Optical clarity	1/1/1/2	1/1/1/2	1/1/1/2	1/2/1/2	1/1/1/2	1/1/1/2	
Shade adjustment	●	-	-	●	●	●	
Sensitiviy adjustment	●	●	●	●	●	●	
Delay adjsutment	●	-	-	●	●	●	
Welding	●	●	●	●	●	●	
Grinding	-	-	-	-	-	-	
Cutting	-	-	-	-	-	-	
TIG > 20 amps	●	●	●	●	●	●	
TIG < 20 amps	-	-	-	●	-	-	
Battery type	Lithium - Fixed	Lithium - Fixed	Lithium - Fixed	Alcaline - Replaceable	Lithium - Fixed	Lithium - Fixed	
Sollar cells	●	●	●	-	●	●	
370 Speed Dial Headgear	-	-	-	-	-	-	
Special Features	-	-	-	Surface Mode technology	-	-	
Warranty	1 Year	1 Year	1 Year	3 Years	1 Year	1 Year	

	BETTER	BEST
--	--------	------

	WF50 SM INT 4/9-12	WF50 TN INT 4/9-13	BALDER TECHNOLOGY WF70 DS 4/9-13	BALDER TECHNOLOGY WF70 ES 4/9-13	BALDER TECHNOLOGY WF70 GDS 4/6-8/9-13
					
	J8172	J8191	J9929	J9928	J9927
	WH30/40 ADVANTAGE	WH30/40 ADVANTAGE	WH70	WH70	WH70
	J8301	J8301	J9931	J9931	J9931
	J8303	J8327	J9932	J9932	J9932
	110 x 90 mm	110 x 90 mm	110 x 110 mm	110 x 110 mm	110 x 110 mm
	96.5 x 60 mm	96.5 x 41 mm	96 x 68.5 mm	96 x 68.5 mm	96 x 68.5 mm
	58 sq cm	40 sq cm	66 sq cm	66 sq cm	66 sq cm
	4/9-12	4/9-13	4/9-13	4/9-13	4/6-8/9-13
	0.04 ms	0.3 ms	0.15 ms	0.15 ms	0.15 ms
	0.1 - 1.0 s	0.2 - 0.8 s	0.1 - 1.0 s	0.1 - 1.0 s	0.1 - 1.0 s
	2	2	2	2	2
	Yes	Yes	Yes	Yes	Yes
	1/2/1/2	1/1/1/2	1/1/1/1	1/1/1/1	1/1/1/1
	●	●	●	●	●
	●	●	●	●	●
	●	●	●	●	●
	●	●	●	●	●
	●	-	-	-	●
	●	-	-	-	-
	●	●	●	●	●
	●	-	●	●	●
	Alcaline - Replaceable	Lithium - Fixed	Lithium - Fixed	Lithium - Fixed	Lithium - Fixed
	-	●	●	●	●
	-	-	●	●	●
	Surface Mode technology	-	Special technology to optimize clarity, solar based, lightweight		
	3 Years	1 Year	5 Years	5 Years	5 Years

NEW

JACKSON[®]
SAFETY

Welding Blankets



Protection against
welding sparks and slag

A / Une / Eine / Una / La

 **SureWerx**[™]

Brand / Marque / Marke / Marca

Ordering E-mail sales@jacksonsafety.eu

Customer Service +386 1 477 67 84

www.jacksonsafety.eu

WELDING BLANKETS - PREMIUM

How do I choose the right welding blanket for the job?

With so many different materials, sizes and functions, it's very difficult to decide what type of welding blanket you might need for the job. When you are unsure of the right style for you, it's good to start with some basic questions:

What constant, intermittent, and melting temperature are you working with?

- **Constant Temperature** – The maximum temperature a blanket can withstand for the entire duration of the application. Sometimes this is referred to as "service temperature" or "working temperature."
- **Intermittent Temperature** – The temperature the fabric can withstand for short durations without damage.
- **Melting Temperature** – The temperature where the fabric is physically damaged due to prolonged exposure.

What should I know about different fiberglass coatings?

There are many different coatings available each with its own specific properties. Listed below are some of the most common styles:

PU	Fiberglass uncoated	Vermiculite
<ul style="list-style-type: none"> • Enhanced abrasion and tear resistance • Soft to the touch 	<ul style="list-style-type: none"> • Easy to cut and can conform to complex curves • Lightweight and soft material 	<ul style="list-style-type: none"> • Advanced abrasion resistance • Can be used without gloves

Which welding blankets are best for vertical and horizontal use?

Lighter duty welding blankets can be used vertically to offer protection against welding sparks and slag. If you are using a blanket horizontally or flat, it is recommended to use a heavier-duty blanket with a higher melt temperature as the spatter has the potential to rest directly on the material.



	LIGHT DUTY		MEDIUM DUTY	HEAVY DUTY
Product Series	Uncoated Fiberglass Blanket	Fiberglass PU Coated Blanket	Vermiculite Blankets	Silica Cloth Blankets
Heat Resistant Temp	550°C	150°C	650°C	1000°C
Colors	White	Yellow	Black	Tan
Weight	510 g (18 oz)	425 g (15 oz)	680 g (24 oz)	510 g (18 oz)
Applications	Heat treating, low thermal conductivity, anti corrosion, and is a base material for coating, impregnating and laminating	Slag resistance, spark resistance and incidental resistant to flames from cutting torches	Abrasion resistance, thermal barrier	Used for thermal and high heat requirements; can be used at 1000°C, melting pt 1700°C
Stress relief – up to 900°C				

NOTE: Temperatures and applications are intended as a guideline only and not a guarantee of performance. SureWerx recommends the use of welding blankets in multiple layers to attain proper molten metal and radiant heat protection. It is the user's responsibility to monitor the activity and use of blankets/high-heat materials at all times. The user must inspect the blankets before use. Abnormal wear and tear should be removed from service.

LIGHT DUTY PROTECTION

Welding Blankets Uncoated Fiberglas

Low irritating
yarns prevents itch



Grommets allow
easy hanging in
vertical applications

550°C working
temperature /
900°C melting
temperature

Ideal for welding,
insulation, and jacketing
applications

Product No	Product Type	Width	Length	Weight (per sq m)	Thickness	Color	Case Qty
J2711	Blanket	1 m	1 m	510 g (18 oz)	0.75 mm	White	20
J2712	Blanket	1 m	2 m	510 g (18 oz)	0.75 mm	White	10
J2713	Blanket	2 m	2 m	510 g (18 oz)	0.75 mm	White	5
J2714	Blanket	3 m	2 m	510 g (18 oz)	0.75 mm	White	5
J2715	Roll	1 m	25 m	510 g (18 oz)	0.75 mm	White	1

Welding Blankets Fiberglass PU Coated

Excellent abrasion
and tear resistance



Grommets allow
easy hanging in
vertical applications

150°C working
temperature /
900°C melting
temperature

Provides protection from
most welding sparks,
spatter and slag

Product No	Product Type	Width	Length	Weight (per sq m)	Thickness	Color	Case Qty
J2716	Blanket	1 m	1 m	425 g (15 oz)	0.47 mm	Yellow	20
J2717	Blanket	1 m	2 m	425 g (15 oz)	0.47 mm	Yellow	10
J2718	Blanket	2 m	2 m	425 g (15 oz)	0.47 mm	Yellow	5
J2719	Blanket	2 m	3 m	425 g (15 oz)	0.47 mm	Yellow	5
J2720	Roll	1 m	25 m	425 g (15 oz)	0.47 mm	Yellow	1

MEDIUM DUTY PROTECTION

Welding Blankets Fiberglass Vermiculite



Advanced abrasion resistant properties

650°C working temperature / 900°C melting temperature

Ideal for welding, furnace applications, pipe wrapping and machinery protection

Grommets allow easy hanging in vertical applications

Heat is dispersed evenly across the surface significantly boosting temperature rating

Product No	Product Type	Width	Length	Weight (per sq m)	Thickness	Color	Case Qty
J2721	Blanket	1 m	1 m	680 g (24 oz)	1 mm	Black	20
J2722	Blanket	2 m	1 m	680 g (24 oz)	1 mm	Black	10
J2723	Blanket	2 m	2 m	680 g (24 oz)	1 mm	Black	5
J2724	Blanket	3 m	2 m	680 g (24 oz)	1 mm	Black	5
J2725	Roll	1 m	25 m	680 g (24 oz)	1 mm	Black	1

HEAVY DUTY PROTECTION

Welding Blankets Silica Uncoated



Pliable material can easily wrap around complex curves

1000°C working temperature / 1700°C melting temperature

Grommets allow easy hanging in vertical applications

Protection from heavy duty slag and molten spatter

Ideal for use as a heat shield, furnace blanket, extreme welding applications and other thermal barrier needs

Product No	Product Type	Width	Length	Weight (per sq m)	Thickness	Color	Case Qty
J2726	Blanket	0.94 m	1 m	510g (18 oz)	0.60 mm	Tan	20
J2727	Blanket	1 m	1.76 m	510g (18 oz)	0.60 mm	Tan	10
J2728	Blanket	2 m	1.76 m	510g (18 oz)	0.60 mm	Tan	5
J2729	Blanket	3 m	1.76 m	510g (18 oz)	0.60 mm	Tan	5
J2730	Roll	0.914 m	25 m	510g (18 oz)	0.60 mm	Tan	1



UV Protection

Protects bystanders from UV and blue light radiation



Injury prevention

Prevents sparks and spatter from injuring bystanders while self-extinguishing properties keep the curtain from burning



Minimizes noise

Creates a sound barrier to minimize noise discomfort and the risk of hearing impairment for nearby workers

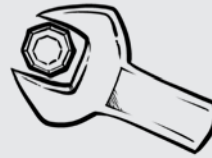

Easy installation

Curtains come grommeted, and when used with frames, are easily hung and can be rearranged

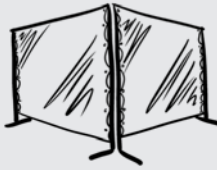

Clear division

Creates a designated space specifically for welding operations while still maintaining visibility



Reduced fumes and vapors

Creates a containment barrier that allows for more efficient fume extraction

Advantages of TRANSPARENT Welding Curtains

Jackson Safety® Welding Curtains

TRANSPARENT WELDING CURTAINS

- Built with grommets for easy hanging
- Durable material resists tearing
- Flame, mildew, and water resistant
- All curtains meet or exceed California Fire Marshall standards or NFPA 701 requirements for flame resistance
- Available in orange and green 14-mil transparent material

Why Choose Orange?

- Puts light back into the welding area to help increase worker productivity
- Can be used around MIG, TIG, arc, and plasma operations
- Excellent for use in assembly areas

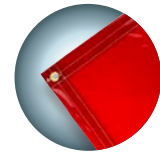

Product No	Width	Length	Weight (per sq m)	Thickness	Color	Amp Usage	Case Qty
36307	6' (1.8 m)	8' (2.4 m)	13 oz.	.014"	Orange	Medium-High	1
36292	6' (1.8 m)	6' (1.8 m)	13 oz.	.014"	Orange	Medium-High	1
37606	6' (1.8 m)	4' (1.2 m)	13 oz.	.014"	Orange	Medium-High	1

Why Choose Green?

- Decreases total light from the welding arc
- Ideal when visibility and light reduction are necessary

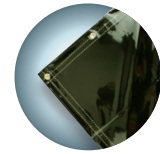

Product No	Width	Length	Weight (per sq m)	Thickness	Color	Amp Usage	Case Qty
36315	6' (1.8 m)	8' (2.4 m)	13 oz.	.014"	Green	Medium-High	1
36299	6' (1.8 m)	6' (1.8 m)	13 oz.	.014"	Green	Medium-High	1
37700	6' (1.8 m)	4' (1.2 m)	13 oz.	.014"	Green	Medium-High	1

WELDING SAFETY SCREENS

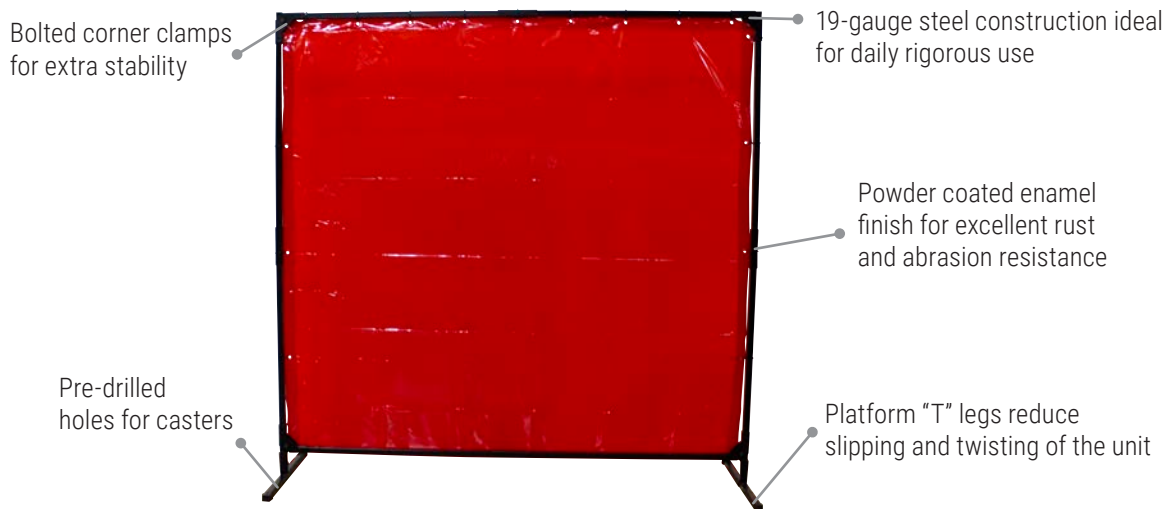

Stur-D-Screen frames and recommended curtains

Frame Only	Frame Size	Orange	Green
36335	6' x 4' (1.8 x 1.2 m) Single Panel	37606	37700
36336	6' x 6' (1.8 x 1.8 m) Single Panel	36292	36299
36338	6' x 8' (1.8 x 2.4 m) Single Panel	36307	36315
37198	Adjustable 6' x 6' to 6' x 8'	36292/36307	36299/36315

Product No	Description	Box Count
36687	Optional hooks for attaching curtains or blankets to welding frames	25 kits
36681	2" Rubber Swivel Castors	10 sets

JACKSON[®]

SAFETY

Work with precision

Jackson Safety[®] Measuring and Marking Tools

CURV-O-MARK

Pipe and tool marking accessories

Curv-o-mark layout tool and systems have earned a reputation for quality and consistency across a wide range of industries. Easy to use and made for an extended working life, these are tools to help bring precision to any layout task.

CURV-O-MARK[®]

PIPE MARKERS

LEVELS AND FLANGE
ALIGNING TOOLS

WRAP-A-ROUND

PIPE MARKERS

CONTOUR MARKERS

The Contour Marker consists of an X frame, calibrated protractor, and a triple-jointed marking arm adjustable to the line to be scribed. A soapstone crayon is required for each radius marker (not supplied). Contour marker is a compact tool design, time saving tool used to lay out pipe and structural steel joints. Ideal for quick precise layout of laterals at any angle, tees, wyes, crosses, elbows - any type or size of joint (for use on same size pipe intersections). Eliminates mathematical formulas. Can be used to lay out pipe from 1-1/2" (3.8 cm) to 18" (45.7 cm) diameter or structural steel members up to 18" (45.7 cm) in a right side up or upside down position.

EU Prod. No	US Prod. No	Description	Pipe Diameter	Pack Qty
J1874	14771	#1 Marker standard	1.5" (3.8 cm) to 18" (45.7 cm) diameter	1
J1875	14772	#2 Adaptor standard	Use with #1 Contour Marker	1
J1877	14773	#4 Marker jumbo	8" (20.3 cm) to 48" (121.9 cm) diameter	1
J1878	14774	#5 Adaptor jumbo	Use with #4 Contour Marker	1

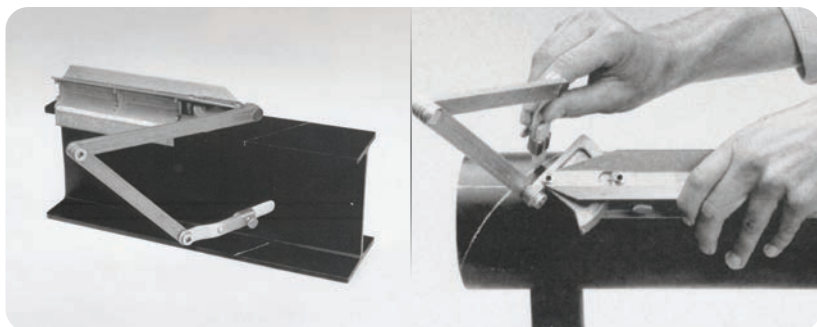

J1874

J1875



J1877



J1878

RADIUS MARKERS

Radius Markers have sturdy friction joints to maintain rigidity and accuracy, and are made from lightweight, rustproof aluminium for extended life. A soapstone crayon is required for each radius marker. Models available in 4 sizes for scribing circles up to 80°.

EU Prod. No	US Prod. No	Description	Pipe Diameter	Pack Qty
J1884	14780	Radius marker mini	Up to 8" (20.3 cm) in radius	1
J1885	14781	Radius marker small	Up to 20" (50.8 cm) in radius	1
J1886	14782	Radius marker standard	Up to 24" (61 cm) in radius	1
J1887	14783	Radius marker jumbo	Up to 10" (25.4 cm) in radius	1



J1884



J1885



J1886



J1887

CENTERING HEADS

Centering Heads aid in the settings of centerlines, establishing angles and marks for butt-ins, locating points inside pipes and tanks, laying out keyways and measuring declivity.

EU Prod. No	US Prod. No	Description	Pipe Diameter	Pack Qty
J1879	14775	#6 Centering head standard	1/2" (1.3 cm) to 4" (10.2 cm) diameter	1
J1880	14776	#7 Centering head jumbo	1" (2.5 cm) + diameter	1



J1879



J1880

MULTI TRAMMEL HEADS

Using standard half inch pipe as a trammel bar, heads feature radius set points cast in alignment with marking pointers for easy setting. Equipped with 1/4" (0,6 cm) screws and squared on the back side of perpendicular alignment. The stationary head holds a 1/4" (0,6 cm) case hardened center point. Moveable head has a 1/8" (0,3 cm) steel scribe hardened. Marks from 1-1/2" circle to any diameter needed, depending on length of pipe used as a trammel bar. Allen wrench, soapstone, scribe and pointer also included.

EU Prod. No	US Prod. No	Description	Pipe Diameter	Pack Qty
J1890	14785	#19 Multi trammel heads	All	1



LEVELS AND FLANGE ALIGNING TOOLS

PRO-MAG LEVEL

A lightweight, easy to use tool for determining angles. Unit is ideal for the pipe fitter, welder, jig builder or anyone who has to determine angles or do setup work. Includes two cast-in 25-pound (11.3 kg) pull magnets that hold securely to any steel surface. Unit has a 360° adjustable DSL with two 90° quadrants graduated in 2-1/2° increments. Cast in tables are used to convert degree-of-angle to rise-in-inches-per-foot or millimeters-per-meter. A groove on the bottom edge permits use on a small pipe.

EU Prod. No	US Prod. No	Description	Pack Qty
J1881	14777	#8 Pro-mag level	1

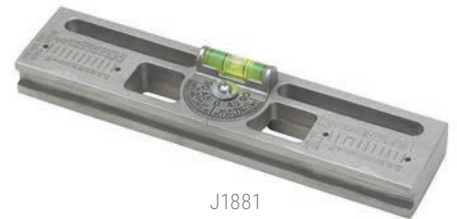

DIAL ANGLE FLANGE LEVEL

A versatile tool that can be used as a dial degree utility level or, with attachments, for two holding flange alignment.

EU Prod. No	US Prod. No	Description	Pack Qty
J1891	14786	#20 Dual-Angle Flange Level—Nonmagnetic; can be used on PVC Pipe	1



UNIVERSAL LEVEL

Universal level is a multi-purpose tool that features a 360° adjustable protractor dial that ensures accurate leveling and permits setting a predetermined pitch of a string of pipe, setting the angle of laterals to a precise degree, trueing vertical runs & two-holding flanges. For structural steel workers, the powerful holding magnets provide an extra hand. Electricians will find the level useful in laying out and lining up heavy conduit.

EU Prod. No	US Prod. No	Description	Pack Qty
J1904	14796	#33 Universal Level	1



PIPE FLANGE ALIGNER

Fast, accurate pipe construction is possible with this self-determining flange aligning tool. The Aligner inserts easily into pipe, centers snugly against the inside pipe diameter and automatically aligns with the pipe axis.

EU Prod. No	US Prod. No	Description	Pack Qty
J1883	14779	#10 Pipe Flange Aligner	1



UNIVERSAL LEVEL

The DSL is an adjustable bubble protractor used with a number of Curv-O-Mark Tools. The protractor covers 180 degrees through two 90 degree quadrants, reading in 2.5 degree increments. The bubble is cast in the aluminium dial.

EU Prod. No	US Prod. No	Description	Pipe Diameter	Pack Qty
J1905	14797	Contour Dial-Set-Level (DSL)	Adjustable Bubble Protractor	1



J1905

FLANGE ALIGNER BASE

Removes the difficulty of flange aligning and squaring. Tool holds a square in the needed position without tying up one's hands. Base is notched at either end for ease in aligning on the center line of the pipe. Two 25-pound (11.3 kg) pull, cast-in magnets for holding either a flat horizontal or vertical position. Base accepts either leg of a standard or combination aluminum square and works on pipe diameters from 1"+, requiring only the extension of the legs of the square being used to accommodate larger diameters.

EU Prod. No	US Prod. No	Description	Pack Qty
J1903	14795	#32 Flange Aligner Base	1



J1903

CENTERING PIN

A hardened steel pin for use with the standard centering head. Suitable for marking, but should not be used as a center punch.

EU Prod. No	US Prod. No	Description	Pack Qty
J1906	14798	Centering pin	1



J1906

WRAP-A-ROUND

Inexpensive tools for marking straight lines around pipe; made from flexible gasket material, providing resistance to both heat and cold. All Wrap-A-Rounds are available in two colours. these designate material type and service temperature. GG (grey) material is used for high temperature applications (up to 550°F) and B (black) material is used for temperatures up to 350°F. Both material types are asbestos free.



EU Prod. No	US Prod. No	Description	Color	Temperature	Size	Pipe Diameter	Pack Qty
J1858	14752	Wrap-a-round 164B EX medium	Black	350°F (176°C)	3.88" (9.8 cm) x 4' (1.2 m)	3" (7.6 cm) to 6" (15.2 cm)	1
J1859	14753	Wrap-a-round 176B large	Black	350°F (176°C)	3.88" (9.8 cm) x 6' (1.8 m)	3" (7.6 cm) to 10" (25.4 cm)	1
J1860	14754	Wrap-a-round 177B EX large 7'	Black	350°F (176°C)	5" (12.7 cm) x 7' (2.1 m)	4" (10.2 cm) to 12" (30.5 cm)	1
J1861	14756	Wrap-a-round 179B EX large 9'	Black	350°F (176°C)	5" (12.7 cm) x 9' (2.7)	6" (15.2 cm) to 16" (40.6 cm)	1
J1867	14763	Wrap-a-round 164GG medium	Grey	550°F (288°C)	3.88" (9.8 cm) x 4' (1.2 m)	3" (7.6 cm) to 6" (15.2 cm)	1
J1868	14764	Wrap-a-round 176GG large	Grey	550°F (288°C)	3.88" (9.8 cm) x 6' (1.8 m)	3" (7.6 cm) to 10" (25.4 cm)	1
J1869	14766	Wrap-a-round 177GG EX large 7'	Grey	550°F (288°C)	5" (12.7 cm) x 7' (2.1 m)	4" (10.2 cm) to 12" (30.5 cm)	1
J1870	14767	Wrap-a-round 179GG EX large 9'	Grey	550°F (288°C)	5" (12.7 cm) x 9' (2.7)	6" (15.2 cm) to 16" (40.6 cm)	1

FACE & EYE PROTECTION PPE



Used in conjunction with protective eyewear, Jackson Safety brand face shields provide a high degree of on the job protection for **high heat applications, grinding, flying debris, and splash protection**. We offer a wide variety of material types and lens tints for extensive coverage.

Please note: Always wear safety glasses when using face shields.

EYEWEAR IS MANDATORY

In many workplace environments, safety eyewear is mandatory due to the range of day-to-day tasks that can cause serious injuries to the eyes. Also safety eyewear is an important part of many employees' everyday workwear.

Safety glasses provide protection from **dust, dirt, flying debris, and other projectiles** created when work operations involve cutting, hammering, crushing, and other related operations.

Safety goggles besides providing protection from **dust, dirt, flying debris, and other projectiles**, also provide protection from **splashes and burns**.

FACE SHIELD - ANOTHER LAYER OF PROTECTION

Used in conjunction with protective eyewear, Jackson Safety[®] Face Shields provide a high degree of on-the-job protection for **heat applications** as well as **grinding, flying debris, splash protection, and more**.

MATERIAL TYPES

● PET

- A low-cost, recyclable option

● Polycarbonate

- Impact performance
- Good performance against heat
- Excellent cold flexibility

Selecting the right PPE to sufficiently reduce exposure to hazards is essential to work safety.

LENS TINTS

● Clear

Allows for maximum visible-light transmission.

● IRUV

Worn for applications and in environments where others are performing welding tasks such as torch brazing, torch soldering, gas welding, and oxygen cutting. Available in Shades 3.0 and 5.0.

● SPECIAL TINTS

Enhances vision and reduces glare by blocking light transmission. Available in light, medium, and dark green tints.



HEALTH
SAFETY

PRODUCTIVITY

Finding a better way

FACE & EYE PROTECTION

GOOD

FACE SHIELDS

NEW

JACKSON®
REUSABLE



SPLASH ONLY

GOGGLES

GLASSES

NEW

SELLSTROM®
SEBRING



BETTER

NEW



JACKSON[®]
170SB



NEW



JACKSON[®]
F4XP



BEST

NEW



JACKSON[®]
MAXVIEW



NEW



JACKSON[®]
QUAD 500



WINDOW OPTIONS

FOR 170SB and F4XP

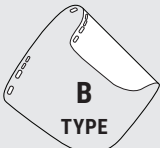

B
TYPE

MOLDED



E
TYPE

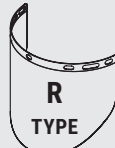

R
TYPE

MOLDED

NEW



JACKSON[®]
GPL500



NEW



SELLSTROM[®]
ODYSSEY SERIES



NEW



JACKSON[®]
SG



NEW



SELLSTROM[®]
B5



NEW



SELLSTROM[®]
PREMIUM



Jackson Safety® Face Shields



MFS-320 SPLASH FACE SHIELD KIT

Reusable

- Ideal for splash protection against liquids and body fluids for health care workers, first responders and in food processing applications.
- Safeguards against splash and dust in a wide range of general use applications.
- Easy-to-install/replace window – quickly snaps on-off the headband for maximum convenience.
- Extra-large full-face coverage for superior protection – check and compare!
- Reusable design – significantly reduces landfill waste and saves on disposal costs!
- Window features an anti-fog coating not found on most other face shields – keeps your vision clear and safe!
- Baseball cap style pinlock head strap ensures quick and easy adjustments – just set it and forget it!
- Window and headband made with recyclable materials and are both replaceable.
- A premium yet cost effective face shield solution – a Jackson Safety exclusive!
- Not designed for use in high impact applications.

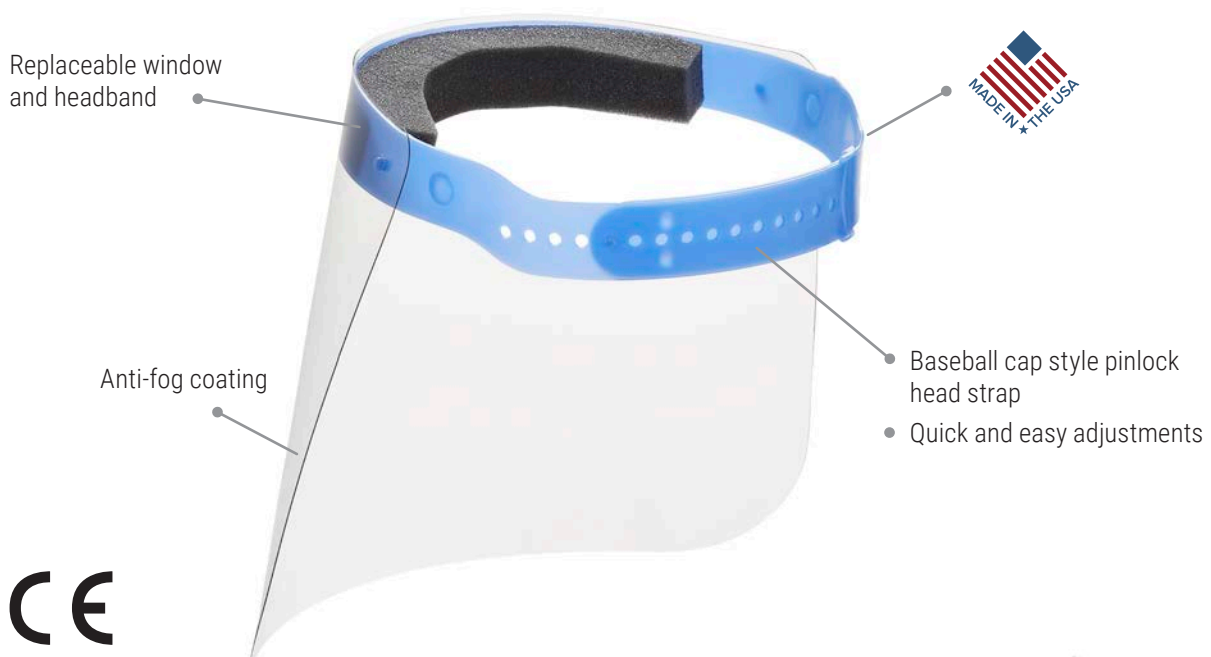

14350

Please note: Always wear safety glasses when using face shields.

Product No	Description	Case Qty
14350	Reusable Splash Face Shield, PET window	24

Jackson Safety[®] Face Shields

170SB HEADGEAR AND WINDOW KIT



Jackson Safety introduces a new headgear and window combination that utilizes the 170-SB headgear with a PC high impact window. The headgear is built with a ratcheting adjuster that makes it easy to use and guarantees a secure fit. Includes a replaceable extra absorbent foam cushioned sweatband for increased operator comfort.

- Ratchet suspension allows easy adjustment and a comfortable fit
- Built-in sweatband keeps perspiration out of workers' eyes
- Lightweight for added comfort
- Made in USA

Heavy duty oversized spark-guard crown for added protection

Convenient easy-to-use ratcheting size adjustment

Wrap-around foam-cushioned sweat band gently hugs the natural shape of the head

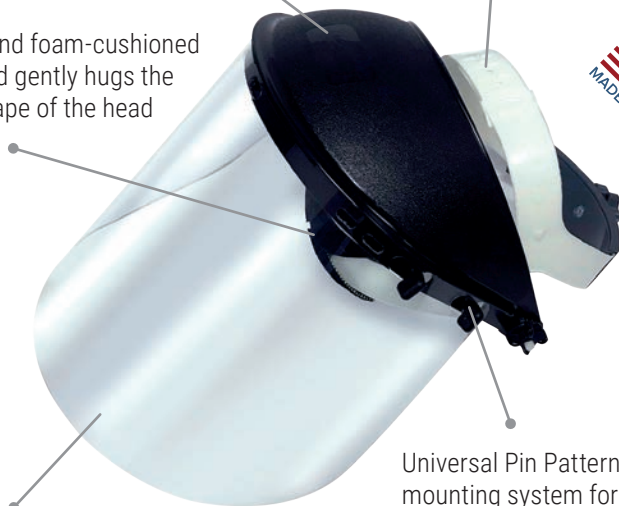

PC high impact window

Universal Pin Pattern window mounting system for use with multiple Jackson window options

WINDOW OPTIONS

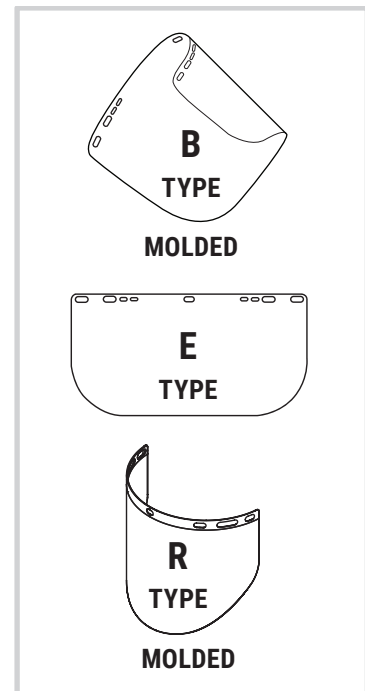

Product No	Description	Case Qty
14953	170-SB Headgear with 30706 clear PC window, uncoated	20

SPARE PARTS & ACCESSORIES

Product No	Description	Case Qty
29057	Face Shield PC window, R type, molded, clear, V8B	12
29058	Face Shield PC window, R type, molded, Shade 3, V8B	12
29059	Face Shield PC window, R type, molded, Shade 5, V8B	12
29087	Face Shield PC window, B type, molded, clear	12
30706	Face Shield PC window, E type, stamped, clear	36



14953

Please note: Always wear safety glasses when using face shields.

NEW

Face Protection

JACKSON[®]
SAFETY



Please note: Always wear safety glasses when using face shields.

Jackson Safety[®] Face Shields



F4XP

Premium Face Shield Crown and Headgear

Jackson Safety[®] offers one of the most extensive universal mount face shield programs in the world! The F4XP premium face shield crown and headgear is designed for maximum comfort, productivity, and ease of use. It can be used with all universal style pin pattern windows.

- Oversized **370 Speed Dial**[™] ratcheting headgear guarantees a precise fit every time
- Patented **"Qwik-Fit"** swivel headband adjusts the suspension gear to the user's head for superior comfort
- Comes standard with a soft fabric sweatband for increased comfort and convenience

EXCLUSIVE!



370[™]
SPEED DIAL

A / Une / Eine / Una / La



Brand / Marque / Marke / Marca

Oversized crown built with premium high impact rated material for maximum protection

For use with all universal pin pattern windows

Designed to offer maximum protection, ease-of-use, and extreme comfort and fit

(14262) F4XP Kit features premium 20 x 38.75 x 0.015 cm molded B type polycarbonate window (29087)



Exclusive quick-change install and removal system ensures fast and efficient window changes



Speed Dial 370™ headgear offers the fastest, easiest, and most efficient ratcheting headgear system in the industry

WINDOW OPTIONS

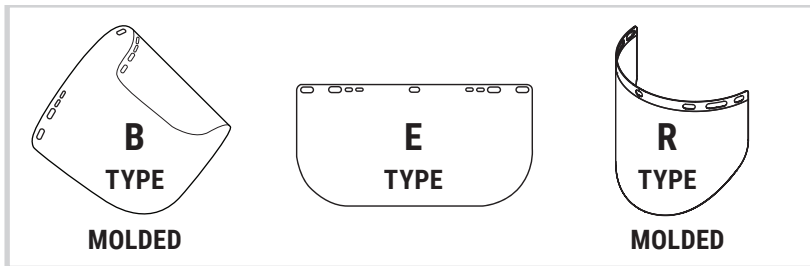

F4XP

Product No	Description	Case Qty
14260	F4XP Crown & 370 Speed Dial Headgear only	12
14262	F4XP Premium Face Shield (crown, headgear, 29087 window B type)	12

SPARE PARTS & ACCESSORIES

Product No	Description	Case Qty
29057	Face Shield PC window, R type, molded, clear, V8B	12
29058	Face Shield PC window, R type, molded, Shade 3, V8B	12
29059	Face Shield PC window, R type, molded, Shade 5, V8B	12
29087	Face Shield PC window, B type, molded, clear	12
30706	Face Shield PC window, E type, stamped, clear	36
20695	370 Speed Dial™ Replacement Headgear	1



14260



14262 (kit)

Includes 29087 molded window

A JACKSON EXCLUSIVE!

NEW

Face Protection



JACKSON[®]
SAFETY

Please note: Always wear safety glasses when using face shields.

Jackson Safety[®] Face Shields



MAXVIEW™

EXCLUSIVE!

Premium Face Shield

The MAXVIEW™ is a premium face shield that features an oversized window to deliver exceptional optical clarity and an industry-leading panoramic view. A built-in side and chin guard protects against splash and flying debris while the extended crown keeps you protected from overhead hazards.

- The Maxview is designed to offer maximum face protection coverage, incorporating an extra-large clear polycarbonate window that is available in two options: without anti-fog treatment or with our premium anti-fog coating
- The high-impact PC window is then framed on the side and chin areas and features an extra-large crown
- This combination translates into maximum coverage, head to lower neck, and side to side. In fact, Maxview offers a full 1" of extra window protection on each side (2" total) versus the leading face shield model, ensuring best-in-class protection and exceptional panoramic views. Check and compare!
- Given its amazing coverage and viewing area, the Maxview is incredibly light
- Maxview incorporates engineered detents that lock in both the up and down positions
- Designed to be used with most goggles, respirators, and all safety glasses
- Premium **370 Speed Dial™** ratcheting headgear suspension - The 370 Speed Dial™ is highlighted by Jackson's famous "Easy Grab-Easy Turn" oversized adjusting dial and patented swivel adjuster band, achieving maximum comfort and fit quickly, easily, and conveniently—saves time, increases productivity, and improves worker safety!



14200

370[™]
SPEED DIAL

A / Une / Eine / Una / La

SureWerx™

Brand / Marque / Marke / Marca

Extended top-of-head coverage protects against hazards from above

Lightweight and balanced construction for all-day comfort

Extra-large polycarbonate window for superior optics and industry-leading panoramic views

Available with premium anti-fog coating

Up and down detents lock securely in place until manually adjusted

Built-in side and chin guard protects against splash and flying debris



Speed Dial 370 headgear achieves maximum comfort and fit



MAXVIEW

Product No	Description	Case Qty
14200	Maxview Premium Faceshield	4
14201	Maxview Premium Faceshield anti-fog coating	4

SPARE PARTS & ACCESSORIES

Product No	Description	Case Qty
14214	Clear replacement window	36
14215	Clear replacement window anti-fog	36
20695	370 Speed Dial™ Replacement Headgear	1



14200

Please note: Always wear safety glasses when using face shields.

A JACKSON EXCLUSIVE!

Please note: Always wear safety glasses when using face shields.

Jackson Safety® Face Shields



QUAD 500™

EXCLUSIVE!

Premium Multi-Purpose Face Shield

The QUAD 500™ is a premium multi-purpose face shield that offers an unparalleled range of face and eye protection solutions. Designed for maximum above-the-neck protection, this product is excellent for heavy-duty grinding, while optional Shade 5 and 8 visors make it ideal for plasma cutting and oxy/acetylene cutting, brazing, and much more.

- All Quad 500 products have been designed to offer maximum above-the-neck face protection, including an extra-large molded polycarbonate window featuring our premium anti-fog coating
- For added protection, the molded window is completely framed on the sides and chin and features an extra-large crown
- The Quad 500 offers exceptional panoramic views with virtually no distortion
- Ideal for grinding, cutting, oxy/acetylene cutting, plasma cutting, brazing and more
- Engineered detents lock in the up or down position until manually adjusted
- Premium **370 Speed Dial™** ratcheting headgear suspension - The 370 Speed Dial™ is highlighted by Jackson's famous "Easy Grab-Easy Turn" oversized adjusting dial and patented swivel adjuster band, achieving maximum comfort and fit quickly, easily, and conveniently—saves time, increases productivity, and improves worker safety!

Available with optional flip-up/flip-down extra-large IR window

- The Quad 500 face shield is also available with an exclusive, **extra-large flip-up/flip-down IR window** for added eye protection when used in applications producing infrared hazards
- It's easy and safe—by keeping the Quad 500 clear window in the down position at all times, the operator can flip the IR shaded window up or down, providing uninterrupted face protection during cutting and grinding operations
- Flip windows available in:
 - **Shade 5 IR** for oxy/acetylene cutting, brazing, and plasma cutting
 - **Shade 8 IR** for oxy/acetylene welding and plasma cutting
- Both the clear and flip windows feature detents that lock in both the up and down positions
- Designed to be used with most goggles, respirators, and all safety glasses



QUAD 500

Product No	Description	Case Qty
14220	Quad 500 Premium Multi-Purpose Face Shield	4
14230	Quad 500 Premium Multi-Purpose Face Shield Flip Visor Shade 5 IR	4
14233	Quad 500 Premium Multi-Purpose Face Shield Flip Visor Shade 8 IR	4

SPARE PARTS & ACCESSORIES

Product No	Description	Case Qty
14250	21.8 x 20.9 x 0.15 cm clear anti-fog window	12
14255	10.94 x 23.12 x 0.017 cm Shade 5 IR visor	12
14258	10.94 x 23.12 x 0.017 cm Shade 8 IR visor	12
20694	370 Speed Dial™ Replacement Headgear	1



14220



14230

A JACKSON EXCLUSIVE!



Jackson Safety® Safety Goggles



GPL500

Premium Goggle / Face Shield

The GPL500 premium safety goggle with flip-up detachable face shield features an ultra-soft body design that easily conforms to your face to deliver a snug, yet comfortable seal. Indirect vents protect against chemical splash while anti-fog coating provides superior optical quality and keeps work uninterrupted.

- Flip-up/flip-down polycarbonate face shield delivers added protection from splash, dust, and flying debris
- Face shield is easily detachable
- Provides 99.9% UV protection
- Specially designed to fit over prescription eyewear
- Clear version is ideal for industrial, mining, construction, pressure washing, grinding and more
- Shade 3 and 5 IR are ideal for oxy/acetylene cutting, brazing, and plasma cutting operations



21001

Ultra-soft body design conforms to your face for superior comfort, fit and safety

Made with indirect vents for added protection from dust and chemical splash

Optically correct lens delivers an exceptional panoramic view

Extra wide flame-retardant strap is swivel mounted to goggle for easy positioning

Anti-fog coating keeps work uninterrupted and safe

Flip-up detachable PC face shield for added protection



GPL500

Product No	Description	Case Qty
21000	GPL500 Goggles, Blue, Clear, anti-fog	6
21001	GPL530 Goggles, Green, Shade 3 IR, anti-fog	6
21002	GPL550 Goggles, Green, Shade 5 IR, anti-fog	6



21000 Clear



21001 Shade 3



21002 Shade 5



NEW

Eye Protection

sellstrom®

Model S80200 shown

Sellstrom® Safety Goggles



ODYSSEY II SAFETY GOGGLE SERIES

- The Odyssey II premium goggle series has been a market leader for 15+ years
- Unique "Dual Sealed" UV absorbing polycarbonate lens technology (except single lens Clean Room and Shade 5 cutting models)
- Dual lens models offer Anti-Fog treatment on inside lens- Anti-Scratch on outside lens
- Industrial, Chemical Splash and Shade 5 models feature top and bottom Indirect Vents providing superior ventilation and the safest operator conditions
- 100% fog free, even in the worst conditions
- Stylish soft goggle body conforms to your face, providing a comfortable yet snug seal and maximum protection against liquids and dust
- Exceptional panoramic views
- Specially designed to fit over prescription eyewear
- Simply the best goggle in the market

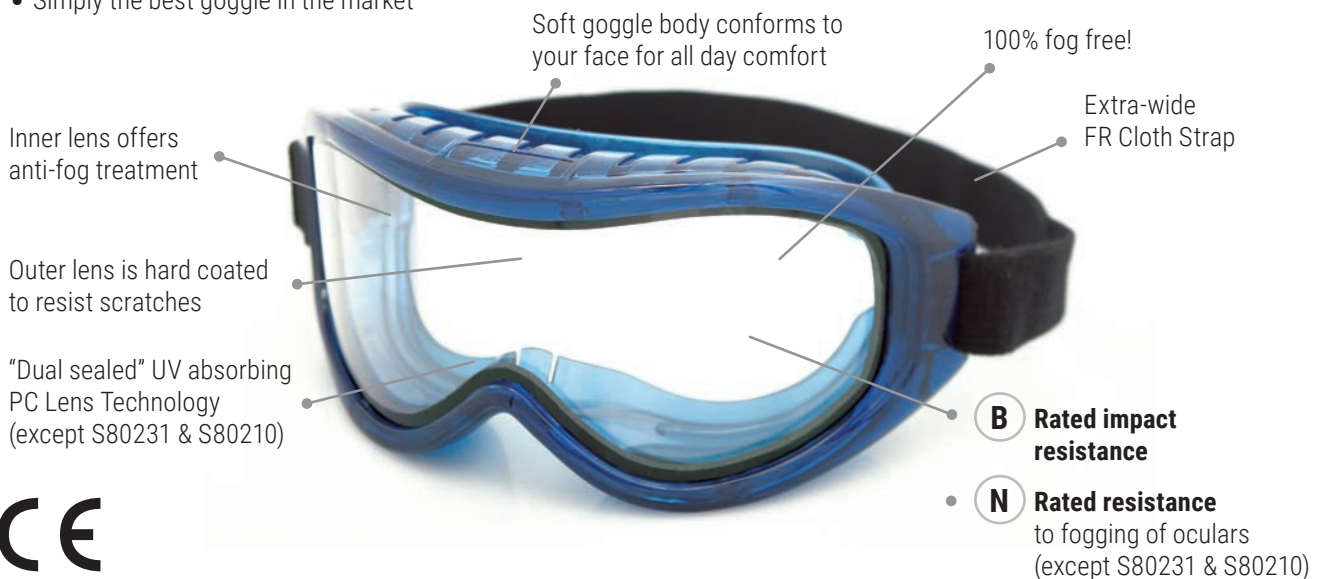

A / Une / Eine / Una / La



Brand / Marque / Marke / Marca

Ordering E-mail sales@jacksonsafety.eu

Customer Service +386 1 477 67 84

www.jacksonsafety.eu

Odyssey II Series Industrial Dual Lens Model

- Our most popular Odyssey II model
- Ideal for a wide variety of applications including construction sites, shop use and general industrial work-place protection
- Complete with extra wide flame retardant cloth strap

Product No	Body Color	Vent Type	Lens	Coatings	Tint	Case Qty
S80200	Blue	Indirect	Dual	HC/AF	Clear	100



S80200

Odyssey II Series Chemical Splash Dual Lens Goggle

- Specifically designed for those applications where the risk of a chemical splash exists
- Complete with extra wide grey, latex free neoprene strap

Product No	Body Color	Vent Type	Lens	Coatings	Tint	Case Qty
S80201	Blue	Indirect	Dual	HC/AF	Clear	100



S80201

Odyssey II Series Clean Room Goggle

- Specifically designed for clean room applications
- Unlike traditional, single use clean room goggles, these premium goggles are re-usable and designed for multi-use clean room applications
- Can be autoclaved
- Top-Vented body with clear uncoated lens
- Complete with extra wide grey, latex free neoprene strap

Product No	Body Color	Vent Type	Lens	Coatings	Tint	Case Qty
S80231	Blue	Top-Vented	Single	Uncoated	Clear	100



S80231

Odyssey II Series Shade 5 Cutting Goggle

- Features a durable Shade 5 IR (single) lens
- Specifically designed for grinding, chipping and brazing operations in fabrication and welding shop applications
- Complete with extra wide flame retardant strap

Product No	Body Color	Vent Type	Lens	Coatings	Tint	Case Qty
S80210	Black (high temp)	Indirect	Single	Uncoated	Shade 5 IR	100



S80210

A SELLSTROM EXCLUSIVE!

Sellstrom® Safety Glasses



SAFETY GLASSES – SHADE 5 IR

- Sellstrom offers safety glasses specifically for use in welding and fabrications shops
- Available in Shade 5 IR for soldering, brazing and cutting operations
- CE certified
- All glasses are made with anti-scratch polycarbonate lenses
- Provide 99.9% UV protection

B5™ Safety Glasses

- Features fold out contouring side shields for maximum eye protection
- Arms are extendable for maximum fit and comfort
- Dual polycarbonate lenses are available in Shade 5 IR

Product No	Temple Color	Side Shield	Lens Tint	Lens Coating	Case Qty
S74751	Black	Black	Shade 5 IR	Hard Coated	12/Box

Arms are extendable for maximum fit and comfort



S74751

Fold-out contouring side shield



Sellstrom® Safety Glasses



SAFETY GLASSES – ADVANTAGE SERIES

- Sellstrom offers affordable safety glasses under the Advantage Series program
- All glasses are made using virgin, unitary polycarbonate lenses
- Provide 99.9% UV protection
- Ideal for construction, shop and general eye protection applications

Sebring™ Safety Glasses

- Classic one-piece molded lens offers excellent front/side protection
- Lightweight, comfortable and very affordable
- Arms are extendable for maximum fit and comfort

Product No	Temple Color	Lens Tint	Lens Coating	Case Qty
S76301	Black	Clear	Hard Coated	12/Box



S76301

N Rated resistance to fogging of oculars



JACKSON[®]

SAFETY

NEW

Eye Protection

JACKSON[®] SG



OUTSTANDING FRAME DURABILITY

While other eyewear snaps under a little bit of stress, the JACKSON[®] SG can handle the pressure.

HEALTH SAFETY PRODUCTIVITY
Finding a better way

Jackson Safety® Safety Glasses



JACKSON® SG

Premium Protective Eyewear

The Jackson® SG series is the only genuine safety eyewear product available under the Jackson Safety® brand. Designed with the wearer in mind, this premium product offers outstanding comfort, fit, style, and durability. Available in a variety of frames and lenses, the Jackson® SG family of products is the clear choice in eye protection.

- Introducing the all new JACKSON® SG series, a premium eye protection product offering outstanding fit, comfort, protection, style, and durability
- Specially designed to offer maximum eye coverage and protection, incorporating a variety of lens shades and coatings
- Made with premium virgin polycarbonate high impact, optically correct wrap style lenses, providing 99.9% UV protection
- Soft temples are curved inwards from front to back to ensure a super comfortable, slip-resistant fit
- As an added advantage, the temple tips are extremely flexible, further ensuring a snug fit while relieving any undue pressure to the user—these glasses are extremely comfortable and stay on during use!
- Frames have been developed using a specially formulated ultra-flexible, ultra-strong base material that provides incredible durability, significantly reducing breakage—check and compare!
- The lightweight frame includes a soft non-allergic nose pad for maximum comfort and fit
- Each safety glass comes complete with a convenient neck strap—no more misplaced or lost glasses!

Frames are lightweight for all-day comfort

Specially formulated ultra-strong material provides unmatched durability and toughness

All models come complete with a convenient neck cord to prevent loss



Provides 99.9% U.V. protection

Soft nose piece offers superior comfort

Variety of styles available for maximum safety and productivity

Wraparound-style lenses extend protection to the periphery

Soft touch temples are slip resistant and provide comfort for hours on end



All standard packs of 12 come with an attractive ready-to-use retail dispenser box



Product No	Frame Color	Lens Design	Lens Description	Lens Coating	Work Environment	Pkg. Qty	Case Qty
50000	Black	Clear	Maximum visible light	Anti-scratch	Indoor/General	12	144
50001	Black	Clear	Maximum visible light	Anti-fog	Indoor	12	144
50002	Black	Amber	Ideal for low lit working environments	Anti-scratch	Low Light	12	144
50003	Black	Amber	Ideal for low lit working environments	Anti-fog	Low Light	12	144
50004	Black	I/O	Reduces glare without distorting original color	Anti-scratch	Indoor/Outdoor	12	144
50005	Black	Blue Shield	Ideal for bright outdoor conditions	Anti-scratch	Outdoor	12	144
50006	Black	Smoke Mirror	Smoke tinted with outer mirror finish coating	Anti-scratch	Outdoor	12	144
50007	Black	Smoke Mirror	Smoke tinted with outer mirror finish coating	Anti-fog	Outdoor	12	144
50009	Black	Blue Mirror	Smoke tinted with outer blue mirror finish	Anti-scratch	Outdoor	12	144



50000/50001



50002/50003



50004



50005



50006/50007



50009



50008



50010



50040/50041/50042



JACKSON® SG IR
INFRARED PROTECTION

Product No	Frame Color	Lens Design	Lens Description	Work Environment	Pkg. Qty	Case Qty
50008	Black	IR 3.0	Protects against infrared and UV radiation	Light cutting/ brazing	12	144
50010	Black	IR 5.0	Protects against infrared and UV radiation	Medium cutting/ brazing	12	144



JACKSON® SG
READERS

Model Number	Frame Color	Lens Design	Reader Strength	Lens Description	Work Environment	Pkg. Qty	Case Qty
50040	Black	Clear	1.5	Maximum visible light	Indoor/General	12	144
50041	Black	Clear	2	Maximum visible light	Indoor/General	12	144
50042	Black	Clear	2.5	Maximum visible light	Indoor/General	12	144

Sellstrom® Safety Glasses



SAFETY GLASSES - PREMIUM SERIES

- Sellstrom offers a wide range of super premium, high quality safety glasses
- Rich in style, comfort, fit and safety
- Each model has been designed to exceed the needs of the most demanding user
- Made with premium virgin polycarbonate high impact lenses
- Lenses are specially coated with Sellstrom's premium Sta-Clear™ Anti-Fog/Anti-Scratch washable lens treatment for maximum performance, durability and life
- Virtually 100% fog free for optimum operator safety
- Provide 99.9% UV protection



XP410 Safety Glasses

- The XP410 offers feather light frames, great style, maximum comfort & fit
- So light, you won't even remember you have them on!
- High impact optically correct wrap style unitary PC lens offers superior coverage
- Stylish, ultra-thin black/green co-molded temples
- Temples are curved inwards to ensure comfortable, slip-resistant fit
- Temple tips are curved outwards for gentle placement and removal
- Soft, co-molded above-the-eye band provides superior eye coverage
- Soft, co-molded nose piece with flexible fingers ensures maximum comfort

Product No	Temple Color	Lens Tint	Lens Coating	Pack. Qty
S72000	Black/Green	Clear	Sta-Clear™ HC/AF	12/Box
S72001	Black/Green	Smoke	Sta-Clear™ HC/AF	12/Box



S72000



S72001

XP450 Safety Glasses

- The XP450 is our sportiest looking safety glass
- Edgy, sleek and modern co-molded temples offer outstanding style and comfort
- High impact optically correct wrap style two-piece PC lenses offer superior coverage
- Lenses are mounted to the frame with a ventilation space, minimizing fogging
- Temples are curved inwards to ensure comfortable, slip-resistant fit
- Temple tips are curved outwards for gentle placement and removal
- Soft nose piece offers all day comfort

Product No	Temple Color	Lens Tint	Lens Coating	Pack. Qty
S72300	Black/Red	Clear	Sta-Clear™ HC/AF	12/Box
S72301	Black/Red	Smoke	Sta-Clear™ HC/AF	12/Box



S72300



S72301

XP460 Safety Glasses

- The XP460 offers a sporty, stylish heavy duty frame and temple design
- Our only full frame premium safety glass
- High impact optically correct two-piece PC lenses offer superior coverage
- Stylish black/green co-molded temples & soft nose piece offers all day comfort
- Temples are curved inwards to ensure comfortable, slip-resistant fit
- Temple tips are curved outwards for gentle placement and removal

Product No	Temple Color	Lens Tint	Lens Coating	Pack. Qty
S72400	Black/Green	Clear	Sta-Clear™ HC/AF	12/Box
S72401	Black/Green	Smoke	Sta-Clear™ HC/AF	12/Box



S72400



S72401

GENERAL PPE

BE AWARE OF YOUR SURROUNDINGS

Making the workplace safe is everyone's responsibility, so make sure that you check your work area and remove all potential hazards before starting.

This small step can ensure you have a productive day at work and arrive home in the same condition that you went to work.

PPE IS THERE TO SAVE YOUR LIFE – USE IT.

It is essential that you wear the correct PPE for the job application. The fit, comfort, colour and certification of the product needs to be right to enable you to deliver your best work. Check them all before you start.

Our livelihoods depend on us doing our best work. The best work is only achieved when your health and safety is guaranteed.

Your first line of defense:

- HEAD PROTECTION
- HEARING PROTECTION
- KNEE PROTECTION
- SLIP PROTECTION



Work is something we all do. The quality of work with safety and health is a basic part of a safety culture. Building a culture that lasts 365 days a year is our goal.

Hard Hat



Jackson Safety hard hat is your first line of defense against potential head injuries. Engineered to deliver superior performance, comfort and style.

Earplugs and earmuffs



Choose from a wide variety of hearing conservation solutions in both disposable and reusable ear plugs and passive style earmuffs.

Knee Pads



Excellent for welders, ship builders, roofers, construction workers, flooring installers and anywhere hard working Knee Pads are required.

Traction Aids



The solution that gives you the utmost confidence on ice and snow. Ice Diamond™ Tungsten Carbide Spikes provide powerful traction with maximum grip.



**HEALTH
SAFETY
PRODUCTIVITY**
Finding a better way

GOOD

BETTER

BEST

HEAD PROTECTION

NEW



HARD HAT



NEW



HEADLAMP



HEARING PROTECTION



H10 EARPLUGS
DISPOSABLE



H20 EARPLUGS
REUSABLE



NEW



H70 EARMUFFS



KNEE PROTECTION

NEW



KNEE PADS
STANDARD



NEW



KNEE PADS
GEL



SLIP PROTECTION

NEW

TRACTION AIDS

K1
MID-SOLE



DUE NORTH
HEEL TRACTION
AIDS



DUE NORTH
LIGHT INDUSTRIAL



DUE NORTH
ALL PURPOSE
INDUSTRIAL



DUE NORTH
HEAVY DUTY



Jackson Safety® Head Protection

CLIMBING STYLE INDUSTRIAL HARD HATS

CH-300 "Climbing-Inspired" Industrial Hard Hat - Non-Vented

- Introducing Jackson's new ultra-modern "Climbing-Inspired" industrial hard hat
- Lightweight, molded from High Density Polyethylene (HDPE)
- Super comfortable 6 pt. ratcheting suspension fits head sizes 6 ½ to 8
- Rapid-Dial ratcheting headgear – just grab and adjust, even with gloves on
- Comfortable and convenient chin strap with molded chin cup for added security
- Comfortable, replaceable sweatband
- More comfortable than "traditional" hard hats
- Four external clips are strategically positioned to securely fasten elastic straps found on LED lighting systems
- Slotted adaptors allow use with hard hat accessories including face shield adaptors & earmuffs
- Ideal for at height and scaffolding work, confined space applications, construction sites requiring chin straps, and general all-around head protection
- Meets ANSI Z89.1-2014, Type 1, Class C, G & E & EN397 European Standards

Modern, stylish "climbing inspired" hard hat shape

Super-comfortable 6-pt. suspension

"Rapid dial" ratcheting mechanism allows quick and easy adjustment—even with gloves on!

Comes standard with convenient built-in chinstrap and cup



CH-300 "Climbing-Inspired" Industrial Hard Hat - Non-Vented

Product No	Cap Color	Suspension	Case Qty
20900	○ White	Rapid Dial	12
20901	● Yellow	Rapid Dial	12
20903	● Orange	Rapid Dial	12
20907	● Black	Rapid Dial	12

SPARE PARTS & ACCESSORIES

Product No	Description	Case Qty
20930	Replacement ratcheting headgear for CH-3	20
20931	Replaceable sweatbands	20
20932	Replacement chin strap	1
20937	Hi-Vis reflective tape kit for CH-300	500



20903

Jackson Safety[®] Head Protection

HEADLAMP TORCHES



Rechargeable SMD/COB Headlamp 250 Lumens

- Combination SMD and COB technology for long distance or wide angle lighting
- Lithium-Ion battery is USB chargeable using any compatible charging block
- Cree XPG SMD provides the ultimate in long distance lighting
- Both light sources feature Low, High, Strobe, and Variable functions
- Hold down either power button to precisely adjust light level to suit your task
- Can be tilted to aim light at the work
- IP54 rated for outdoor use
- Anti-slip strap and hooks keep light from slipping up when worn with a hard hat

TECHNICAL DATA

Batteries	Li-ion	Lumens at High Power	250
Beam Distance	117	Lumens at Low Power	85
Charger	USB	Run Time at High Power	3 hrs
Charging Time	2.5 hrs	Run Time at Low Power	10 hrs

Product No	Description	Case Qty
16250	Rechargeable smd/cob Headlamp 250 Lumens	6



COB Headlamp 150 Lumens

- COB technology for wide angle and close up work
- High, Low, and Strobe functions
- IP54 rated for outdoor use
- Can be tilted to aim light at the work
- Anti-slip strap and hooks keep light from slipping up when worn with a hard hat
- Includes batteries
- Sold in 6 pc POP display only

TECHNICAL DATA

Batteries	3 x AAA	Lumens at Low Power	40
Beam Distance	5	Run Time at High Power	4 hrs
Lumens at High Power	150	Run Time at Low Power	16 hrs

Product No	Description	Case Qty
16150	Cob Headlamp 150 Lumens	6



16250

IP 5 4



16150

IP 5 4

Hearing Protection

Why is Hearing Protection important?

Continued exposure to noise above certain levels causes permanent hearing damage. Hearing cells cannot be repaired nor do they regenerate.

When does it become a problem?

Workers are exposed to noise levels at different frequencies that may vary depending on the type of industry and activities performed. Noise levels above 80dB will start causing progressive hearing damage as the noise intensity and exposure increase.

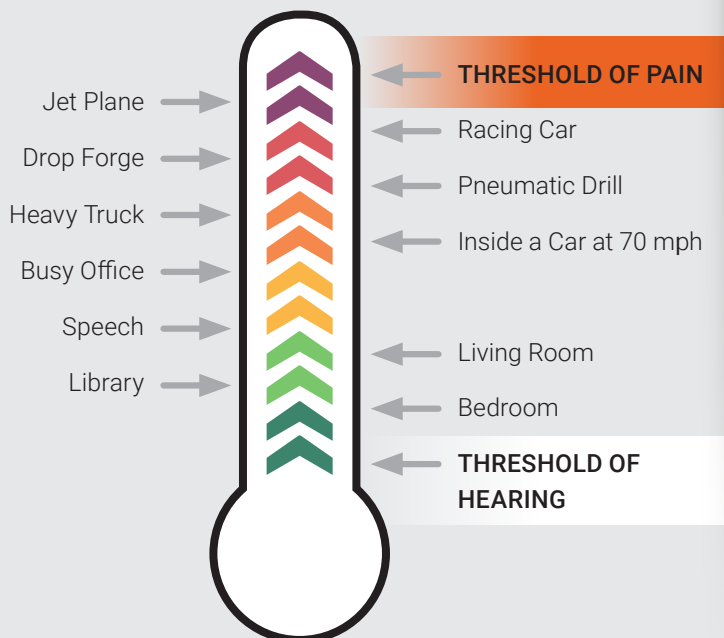

**PROVIDE
SAFE WORKING
CONDITIONS**

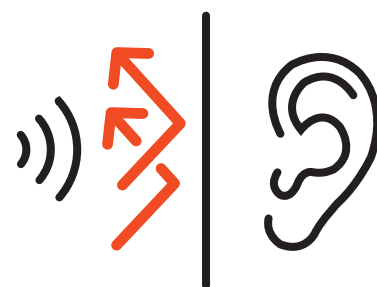

Getting to Know Hearing

Hearing protection should be taken very seriously and protectors, either muffs or plugs, should be comfortable to wear and offer sufficient attenuation to prevent hearing loss based on individual protection needed.

What Level of Protection Do You Need?

The SNR number gives consumers a methodology to judge performance among different models of hearing protectors. A higher number indicates more effective protection against sound.

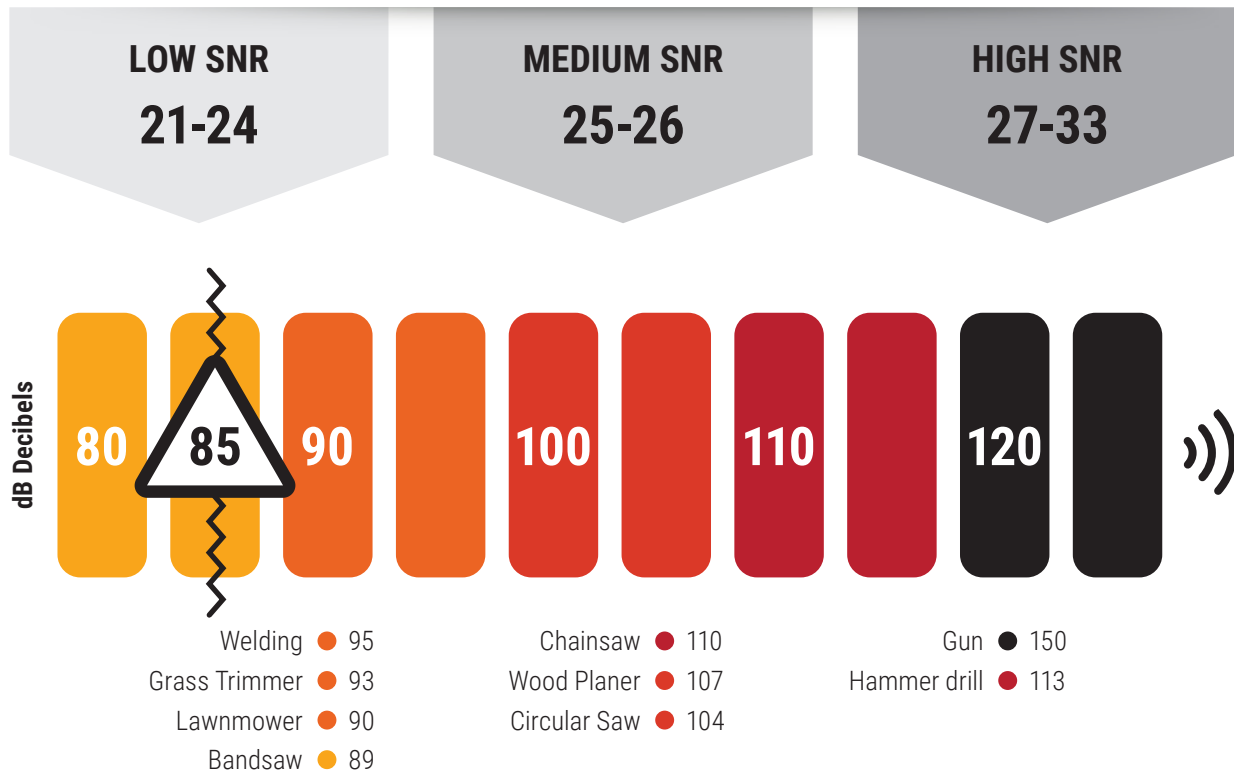

Employer's responsibilities

Under EU noise legislation, employers must provide the option of suitable hearing protection where noise exceeds 80dB(A). At 85dB, employers must provide and strictly enforce the use of Hearing Protection.

European standards require that hearing protection equipment is tested to determine the Single Number Ratings (SNR) of each product. This is calculated when environmental noise level and the desired final noise levels, at the end organ of hearing, are subtracted.

Jackson Safety® Hearing Protection provides quality, comfort and ease-of-use in reusable and disposable styles for excellent attenuation in a wide variety of noise-level environments. For hearing protection solutions, choose from a wide variety of earplugs, clips and passive earmuffs designed to make your workday safer and more productive.

Jackson Safety® Ear Muffs



H70 VIBE® PREMIUM DIELECTRIC EARMUFF

- Jackson's exclusive H70 Vibe earmuffs offer premium comfort, fit, and protection
- Stylish, modern lightweight design
- Dielectric durable thermoplastic material protects you from electric shocks and shorts
- Head band, swivel fork arms and cup pads have been carefully designed to deliver strength, durability, consistent noise reduction and most importantly to offer a comfortable snug fit with minimal pressure for all day comfort
- Cup pads are super soft and comfortable – ideal for extended use
- Easily adjustable for quick and convenient positioning
- Features soft foam head band padding for maximum operator comfort and style
- Available in both banded, and hard hat cap mount format for use with slotted hard hats
- Comes in colored box with integrated fold-out hang tag

Soft foam head band for comfort and style

Easily adjustable for quick positioning

Made completely from dielectric materials

Dielectric – protects you from electric shocks

Super soft and comfortable cup pads - ideal for extended use

20774



Head Band

- Innovative design with soft padded headband which adjusts to fit most head shapes and sizes
- Dielectric, durable thermoplastic material retains shape and pressure for consistent noise reduction
- Various noise reduction levels available

Product No	Cup Color	Head Band	SNR Rating	Case Qty
20773	Orange	Comfort Foam	29	1
20774	Red	Comfort Foam	31	1
20775	Black	Comfort Foam	34	1

Cap Mounted

- Designed to mount on to most brands of slotted hard hats
- Cup pads are soft and comfortable – ideal for extended use
- Easily adjustable for quick and convenient positioning
- Various noise reduction levels available
- Fits Jackson CH300 Series Climbing Style hard hat

Product No	Cup Color	Head Band	SNR Rating	Pack Qty
20776	Orange	Cap Mount	27	1
20777	Red	Cap Mount	29	1
20778	Black	Cap Mount	32	1

A JACKSON EXCLUSIVE!



20773



20778

Jackson Safety® Earplugs



H10 HEARING PROTECTION

Disposable Earplugs

- Soft roll-down foam for easy insertion
- High visibility for easy compliance monitoring
- Each pair individually bagged
- Corded options available
- Also available in corded metal detectable option
- Longer and softer for helping correct insertion
- Ideal releasing time
- Ideal for high noise environments

EN 352-2



H10 HEARING PROTECTION

Product No	Description	SNR Rating	Box Qty	Case Qty
67212	Disposable earplugs corded	31 dB	100 Pairs	8 Boxes
13821	Metal detectable corded	34 dB	100 Pairs	8 Boxes



67212



13821



Jackson Safety[®] Earplugs



H2O HEARING PROTECTION

Reusable Earplugs

- High visibility for easy compliance monitoring
- Soft design to ensure comfort and conformity
- Specific design for easier holding and donning
- Each pair individually bagged in resealable bags to maximize productivity and efficiency
- Ideal for medium-low noise environment

H2O HEARING PROTECTION

Product No	Description	SNR Rating	Box Qty	Case Qty
13822	Reusable metal detectable corded	27 dB	100 pairs	4 Boxes
67220	Reusable earplugs uncorded	25 dB	100 pairs	4 Boxes



13822



67220



Jackson Safety® Knee Pads



KNEE PADS - PREMIUM GRADE

Jackson Safety Ultra-Flex Knee Pads

- The articulating hinged design ensures proper placement all day long – set them once and forget you are even wearing them
- Soft elastic, extra-wide woven straps with reinforced sewn ends are placed well above and below the knee – no Velcro, which contaminates over time
- Straps stay aligned with your legs in any position – will not bind behind the knee
- Built with strong, flexible hard plastic outer shells that extend well above, below and to the inside/outside of the knee for added knee and leg protection
- Metal rivet hinge ensures long lasting protection while kneeling or walking
- On the outside, pads feature a perfectly placed curved non-marking Grip Strip
- Grip-Strip designed for use in all applications without gumming up
- On the inside, pads offer a long lasting 16 mm (5/8") closed cell foam pad for maximum comfort and protection
- Sweat does not penetrate closed cell foam – lasts longer and won't "stink"
- Our Jackson Safety Ultra-Flex Gel version offers even greater user comfort and protection through the use of a three layer, 19 mm (¾") thick closed cell foam pad with built-in GEL packs – the ultimate in knee protection!
- Virtually indestructible – built for years of hard work and heavy use
- Specially designed Quick-Snap clips ensure quick and easy removal
- Comes in convenient, reusable mesh bag with one extra Quick-Snap clip
- Pads weigh only 260 g (9 oz.) each
- Excellent for welders, ship builders, roofers, construction workers, flooring installers and anywhere hard working knee pads are required



95110



95111



95112

JACKSON SAFETY ULTRA-FLEX KNEE PADS

Product No	Shell Color	Grip Strip	Box/Case Qty
95110	Grey	Red	6/24 pair
95111	Black	Red	6/24 pair
95112	Green	Red	6/24 pair

Jackson Safety Ultra-Flex Gel Knee Pads

- The Jackson Safety Ultra-Flex Gel Knee Pads offers all of the same legendary features as the Jackson Safety Ultra-Flex pad but has the added advantage of a built in GEL pack for supreme comfort and fit
- This is the ultimate knee pad for extreme applications where users are on their knees for extraordinarily long periods of time
- Unlike many GEL pads on the market, our GEL packs are securely placed inside a three layer, 19 mm ($\frac{3}{4}$ ") closed cell foam knee protector compartment and are guaranteed to stay leak-free
- Available with black shells and Hi-Viz orange Grip Strip



JACKSON SAFETY ULTRA-FLEX GEL KNEE PADS

Product No	Shell Color	Grip Strip	Box/Case Qty
95211	Black	Hi-Viz Orange	6/24 pair

NEW

Slip Protection

K1
S E R I E S

K1 ICE CLEATS

● ICE CLEAT POLICY TACKLING THE GREY AREA

- We have too many people that want to argue the 'grey area' about when to wear their cleats and when not to.
- Ice cleats are mandatory, but somehow they're always 'forgotten' in the truck when a slip-and-fall injury occurs.
- With full-foot type the floors inside kept getting damaged.

Winter Slips and falls are prevalent problems in nearly every industry from construction to mining to couriers to home-care providers.

● THE GRIP THAT CHANGED THE GAME

- **One size** fits most
- Provides **outstanding traction** on slippery surfaces with ice and snow
- **Easily rotate to the top** of the foot when transitioning indoors, driving a vehicle, or climbing a ladder
- **No need to remove cleats** to transition indoors
- **High-visibility** adjustable strap
- Constructed with **industrial-quality** tungsten carbide and winter tire rubber
- **Reflective patch** for additional safety in low-light conditions
- Suitable for both **heavy industrial applications** and **casual use**, such as walking from a parking lot to an office
- Easy-to-distribute, vending machine-ready poly bag packaging



A / Une / Eine / Una / La

 **SureWerx**[™]

Brand / Marque / Marke / Marca

Ordering E-mail sales@jacksonsafety.eu

Customer Service +386 1 477 67 84

www.jacksonsafety.eu

K1 | **MID-SOLE**
SERIES

ORIGINAL

- Ideal for boots with a defined heel

Sizes: **ONE SIZE FITS MOST**



Product No	Description	Case Qty
K1MID	K1 MID-SOLE Original	25



K1MID

LOW PROFILE

- Narrower rubber platform and shorter studs ideal for footwear with shallow arches

Sizes: **ONE SIZE FITS MOST**



Product No	Description	Case Qty
K1MID-LP	K1 MID-SOLE Low Profile	25



K1MID-LP

INTRINSIC

- Ideal for boots with a defined heel
- Certified for volatile environments with gases, vapor, fibers and dust
- Suitable for a range of applications including oil & gas, chemicals, utilities and energy, wastewater, and agriculture



BURNABLE MATERIAL	CERTIFICATIONS (IEC*)
Gas or vapor	Zones 0, 1 or 2
Dust	Zones 20, 21 or 22
Fibers	Zones 20, 21 or 22

* IEC: International Electrotechnical Commission

Sizes: **ONE SIZE FITS MOST**

Product No	Description	Case Qty
K1MID-INT	K1 MID-SOLE Intrinsic	25



K1MID-INT





HTA - HEEL TRACTION AID

- Ideal for drivers, delivery personnel or anyone operating machinery where use of a conventional, full coverage traction aid may interfere with driving capabilities
- The HTA has two unique design features that quickly and easily allow the user to flip the traction pad or slide the traction pad out from underneath the heel when encountering a walking surface that may be damaged.
- Convenient hook and strap with adjustment system provides a quick, easy, comfortable and secure fit on a wide variety of footwear.
- 8 Military Grade Tungsten Carbide Due North® Ice Diamond™ Spikes per pair, along with bi-directional tread, provides powerful traction with maximum grip.

Sizes: **ONE SIZE FITS MOST**



REPLACEABLE
ICE DIAMOND™
TUNGSTEN CARBIDE SPIKES



Product No	Description	Case Qty
V3550470-0/S	Heel Traction Aid Due North	24





ALL-PURPOSE INDUSTRIAL

- All-around solution for the tough work environment. Best for those who work hard and play harder outdoors.
- New enlarged traction heel pad with 2 additional spikes and more heel coverage for increased traction and stability.
- "Pulse Grip" tread design over a larger surface area provides more traction on all surfaces.
- 100% Natural Rubber maximizes durability while maintaining elasticity in subzero temperatures.
- Geometrically designed webbing and improved shape comfortably fit a greater variety of footwear.
- 16 Military Grade Tungsten Carbide spikes per pair.

Sizes: **S** (fits: UK M 3.5-6.5, W 2.5-5.5; EURO 35-39),
M (fits: UK M 7-9.5, W 6-8.5; EURO 39-43),
L (fits: UK M 10-12.5, W 9-10.5; EURO 43-46),
OSD (fits: UK M 13-14.5, W 11-12.5; EURO 46-50)

Product No	Description	Case Qty
V3550370-L	All Purpose Industrial - Large	24
V3550370-M	All Purpose Industrial - Medium	24
V3550370-S	All Purpose Industrial - Small	24
V3550370-XL	All Purpose Industrial - Oversized	24



REPLACEABLE
ICE DIAMOND™
 TUNGSTEN CARBIDE SPIKES

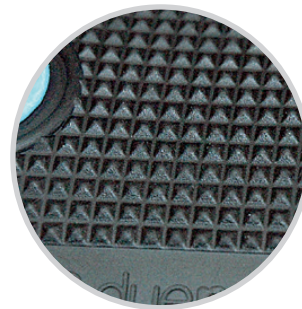

DIAMOND KNURLING
 Textured "Diamond Knurling" inner lining grips the footwear, keeping traction aids stable and in place





LIGHT INDUSTRIAL

- Ideal for the worker who occasionally needs additional traction on ice and snow while performing their outdoor duties.
- 100% Natural Rubber stays strong and retains elasticity in subzero temperatures for maximized durability.
- New & improved toe-box design enhances fit and function along with a 360-degree spike pattern that provides more push and lateral grip.
- Unique support hole on heel strap provides easy adjustment and makes it easy to put on and take off.
- 12 Military Grade Tungsten Carbide Due North® Ice Diamond™ Spikes per pair are integrated into a proprietary rubber tread design from improved traction.

Sizes: S/M (fits: UK M 2-6.5, W 2.5-7; EURO 35-40),
L/XL (fits: UK M 7.5-13.5, W 7.5+; EURO 41-49)

Product No	Description	Case Qty
V3550170-L/XL	Light Industrial Traction Aid Due North - Lg/Xlg	24
V3550170-S/M	Light Industrial Traction Aid Due North - Sml/Med	24



REPLACEABLE
ICE DIAMOND™
 TUNGSTEN CARBIDE SPIKES





HEAVY-DUTY INDUSTRIAL

- The solution for extreme winter work environments to give you the utmost confidence on ice and snow.
- Industrial grade sole is made from 100% Natural Rubber that features unparalleled grip and maximum durability in ice/snow conditions.
- The integral retention strap ensures fit in all conditions.
- 28 Strategically placed molded-in spikes per pair, maximize traction while virtually eliminating the possibility of spikes coming out, even in extreme conditions.
- IceDiamond™ Military Grade tungsten carbide spikes last longer and hold an ice piercing edge better than steel.

Sizes: **S** (fits: UK M 3.5-6.5, W 2.5-5.5; EURO 35-39),
M (fits: UK M 7-9.5, W 6-8.5; EURO 39-43),
L (fits: UK M 10-12.5, W 9-10.5; EURO 43-46),
OSD (fits: UK M 13-14.5, W 11-12.5; EURO 46-50)

Product No	Description	Case Qty
V3550570-L	Heavy Duty Traction - Large	24
V3550570-M	Heavy Duty Traction - Medium	24
V3550570-S	Heavy Duty Traction - Small	24
V3550570-XL	Heavy Duty Traction - Oversized	24

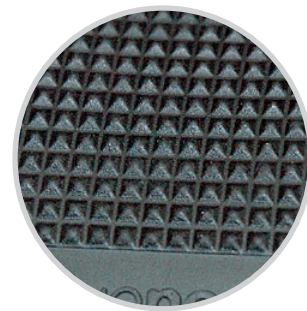

DIAMOND KNURLING
 Textured "Diamond Knurling" inner lining grips the footwear, keeping traction aids stable and in place



Slip Protection



OUR RETAIL SELECTION



- 100% Natural Rubber stays strong and retains elasticity in subzero temperatures for maximized durability
- Easy to take on & off
- Easily Adjustable



REPLECEABLE
ICE DIAMOND™
TUNGSTEN CARBIDE SPIKES

Product No	Case Qty
V3550770-0/S	24



EVERYDAY G3

Product No	Case Qty
V3551270 - L/XL, S/M	24



EVERYDAY PRO

Product No	Case Qty
V3551370 - L/XL, S/M	24



ALL PURPOSE

Product No	Case Qty
V3550270 - S, M, L, XL	24



» Massage Relief for Tired Achy Feet



« Massage Sore, Tight and Tired Muscles



Plantar Fasciitis Relief



FOOT RUBZ BALL
"THE ORIGINAL"

Product No	Case Qty
V4550150-0/S	24



FOOT MASSAGE ROLLER
"CUSTOMER FAVORITE"

Product No	Case Qty
V4550250-0/S	24



FULL BODY MASSAGE TOOL
"2-IN-1 MASSAGER"

Product No	Case Qty
V4550350-0/S	24

Rubz products fulfill chemical compatibility requirements according to REACH Regulation (EC) 1907/2006 Annex XVII and pH value requirements according to EN ISO 3071:2006.

PRODUCT INDEX

Product No	Page
13821 H10 Metal detectable corded	108
13822 H20 Reusable metal detectable corded	109
14200 Maxview Faceshield	87
14201 Maxview Faceshield anti-fog coating	87
14214 Maxview clear replacement window	87
14215 Maxview clear replacement window anti-fog	87
14220 Quad 500 Faceshield	89
14230 Quad 500 Faceshield Flip Shade 5 IR	89
14233 Quad 500 Faceshield Flip Shade 8 IR	89
14250 Quad 500 clear window anti-fog	89
14255 Quad 500 Shade 5 visor	89
14258 Quad 500 Shade 8 visor	89
14260 F4XP Crown & 370 Speed Dial Headgear only	85
14262 F4XP Premium Face Shield (crown, headgear, window)	85
14350 MFS-320 Reusable Splash Face Shield, PET window	82
14752 Wrap-a-round 164B EX medium	77
14753 Wrap-a-round 176B large	77
14754 Wrap-a-round 177B EX large 7'	77
14756 Wrap-a-round 179B EX large 9'	77
14763 Wrap-a-round 164GG medium	77
14764 Wrap-a-round 176GG large	77
14766 Wrap-a-round 177GG EX large 7'	77
14767 Wrap-a-round 179GG EX large 9'	77
14771 Marker standard	75
14772 Adaptor standard	75
14773 Marker jumbo	75
14774 Adaptor jumbo	75
14775 Centering head standard	75
14776 Centering head jumbo	75
14777 Pro-mag level	76
14779 Pipe flange aligner	76
14780 Radius marker mini	75
14781 Radius marker small	75
14782 Radius marker standard	75
14783 Radius marker jumbo	75
14785 Multi trammel heads	76
14786 Dial angle flange level	76
14795 Flange aligner base	77
14796 Universal level	76
14797 Dial & level	77
14798 Centering pin	77
14953 170-SB Headgear with 30706 clear PC window, uncoated	83
16150 Cob Headlamp 150 Lumens	103
16250 Rechargeable SMD/COB Headlamp 250 Lumens	103
20693 Translight Replacement 370 Headgear	51, 53, 55, 59
20694 370 Speed Dial Headgear - for Quad 500	59, 89
20695 370 Speed Dial Headgear - for Maxview/F4XP	59, 85, 87
20773 H70 Earmuff, head band, orange	107
20774 H70 Earmuff, head band, red	107
20775 H70 Earmuff, head band, black	107
20776 H70 Earmuff, mounted, orange	107
20777 H70 Earmuff, mounted, red	107
20778 H70 Earmuff, mounted, black	107
20900 CH-300 Hard Hat, white	102
20901 CH-300 Hard Hat, yellow	102
20903 CH-300 Hard Hat, orange	102
20907 CH300 Hard Hat, black	102
20930 Replacement ratcheting headgear for CH-300	102
20931 Replaceable sweatbands for CH-300	102
20932 Replacement chin strap for CH-300	102
20937 Hi-Vis reflective tape kit for CH-300	102
21000 GPL500 Goggles, Blue, Clear, anti-fog	91
21001 GPL530 Goggles, Green, Shade 3 IR, anti-fog	91
21002 GPL550 Goggles, Green, Shade 5 IR, anti-fog	91
29057 Face Shield PC window, R type, molded, clear, V8B	83, 85
29058 Face Shield PC window, R type, molded, shade 3, V8B	83, 85
29059 Face Shield PC window, R type, molded, shade 5, V8B	83, 85
29087 Face Shield PC window, B type, molded, clear	83, 85
30706 Face Shield PC window, E type, stamped, clear	83, 85

Product No	Page
36292 Welding Curtain, orange, 1.8x1.8m	73
36299 Welding Curtain, green, 1.8x1.8m	73
36307 Welding Curtain, orange, 1.8x2.4m	73
36315 Welding Curtain, green, 1.8x2.4m	73
36335 Welding screen 6' x 4'	73
36336 Welding screen 6' x 6'	73
36338 Welding screen 6' x 8'	73
36681 Rubber Swivel Castors	73
36687 Hooks for curtains and blankets	73
37198 Welding screen, adjustable 6' x 6' to 6' x 8'	73
37606 Welding Curtain, orange, 1.8x1.2m	73
37700 Welding Curtain, green, 1.8x1.2m	73
40040 AIRMAX+ PAPR with Translight 355 Welding Helmet	18, 19, 20
40041 AIRMAX+ PAPR with Translight Flip 455 Welding Helmet	21
40043 AIRMAX+ PAPR with Translight+ 555 Welding Helmet	23
40070 AIRMAX+ with Soft Hood, white	29
40071 AIRMAX+ with Soft Hood, black	29
40100 Translight 355 shell with Face Seal and Airduct	19
40101 Translight Flip 455 shell with Face Seal and Airduct	21
40103 Translight+ 555 shell with Face Seal and Airduct	23
40170 Replacement hood, white	29
40171 Replacement hood, black	29
40175 Disposable soft hood	29
40200 Translight 355 PAPR Face Seal	19
40201 Translight Flip 455 PAPR Face Seal	21
40203 Translight+ 555 PAPR Face Seal	23
40311 AIRMAX+ Replacement Pre-filters	17, 19, 21, 23, 27, 29
40312 AIRMAX+ Odour Removing Filter	17, 19, 21, 23, 27, 29
40332 HEPA PAPR filter	17, 19, 21, 23, 27, 29
40340 Airmax+ FR Hose with cover, 85 cm	17, 27, 29
40341 AIRMAX+ FR Hose with cover, 105 cm	17, 19, 21, 23
40353 AIRMAX+ Replacement 4-Cell 7.4V Battery	17, 19, 21, 23, 27, 29
40363 AIRMAX+ PAPR charger	17, 19, 21, 23, 27, 29
40371 AIRMAX+ Replacement Waist belt	17, 19, 21, 23, 27, 29
40372 Washable belt	29
40381 AIRMAX+ blower unit	17, 19, 21, 23, 27, 29
40391 PAPR Carrying Bag	15, 19, 21, 23, 25
46200 Rebel ADF Welding Mask	49, 65
46230 TRANSLIGHT 355 Welding Helmet with ADF, black	51
46240 TRANSLIGHT FLIP 455 Welding Helmet with ADF, black	53
46241 TRANSLIGHT FLIP 455 Welding Helmet with Hard hat and ADF, black	53
46250 TRANSLIGHT+ 555 Welding Helmet with ADF, black	55
46432 Translight 355 Replacement ADF	51, 65
46440 Solera 110 x 90 mm ADF	65
46442 Translight 455 Replacement ADF	53, 65
46452 Translight+ 555 Replacement ADF	55, 65
46470 Solera 108 x 51 mm ADF	65
46480 Solera 110 x 60 mm ADF	65
46600 Rebel Replacement FR Hood	49
46640 Translight Flip 455 Face Shield Replacement Window	53
46641 Translight Flip 455 Replacement Hard Hat	53
46913 Translight 355 Internal Safety Plates (Pack of 10)	51
46914 Translight 455 Internal Safety Plates	53
46915 Translight+ 555 Internal Safety Plates (Pack of 10)	55
46923 Translight 355/455 External Safety Plates	51, 53
46925 Translight+ 555 External Safety Plates	55
46930 Rebel Replacement Lens Kit	49
46993 Translight 355 Lens retainer	51
46994 Translight Flip 455 Lens retainer	53
46995 Translight+ 555 Replacement Retainer	55
50000 Jackson SG, clear, anti-scratch	97
50001 Jackson SG, clear, anti-fog	97
50002 Jackson SG, amber, anti-scratch	97
50003 Jackson SG, amber, anti-fog	97
50004 Jackson SG, I/O, anti-scratch	97
50005 Jackson SG, Blue Shield, anti-scratch	97
50006 Jackson SG, Smoke Mirror, anti-scratch	97
50007 Jackson SG, Smoke Mirror, anti-fog	97
50008 Jackson SG, IR 3	97

Product No	Page
50009 Jackson SG, Blue Mirror, anti-scratch	97
50010 Jackson SG, IR 5	97
50040 Jackson SG, readers 1.5	97
50041 Jackson SG, readers 2.0	97
50042 Jackson SG, readers 2.5	97
67212 H10 Disposable earplugs corded	108
67220 H20 Reusable earplugs uncorded	109
95110 Jackson Ultra-Flex Knee Pads, grey	110
95111 Jackson Ultra-Flex Knee Pads, black	110
95112 Jackson Ultra-Flex Knee Pads, green	110
95211 Jackson Ultra-Flex Gel Knee Pads, black	111
J1858 Wrap-a-round 164B EX medium	77
J1859 Wrap-a-round 176B large	77
J1860 Wrap-a-round 177B EX large 7'	77
J1861 Wrap-a-round 179B EX large 9'	77
J1867 Wrap-a-round 164GG medium	77
J1868 Wrap-a-round 176GG large	77
J1869 Wrap-a-round 177GG EX large 7'	77
J1870 Wrap-a-round 179GG EX large 9'	77
J1874 Marker standard	75
J1875 Adaptor standard	75
J1877 Marker jumbo	75
J1878 Adaptor jumbo	75
J1879 Centering head standard	75
J1880 Centering head jumbo	75
J1881 Pro-mag level	76
J1883 Pipe flange aligner	76
J1884 Radius marker mini	75
J1885 Radius marker small	75
J1886 Radius marker standard	75
J1887 Radius marker jumbo	75
J1890 Multi trammel heads	76
J1891 Dial angle flange level	76
J1903 Flange aligner base	77
J1904 Universal level	76
J1905 Dial & level	77
J1906 Centering pin	77
J2711 Welding Blankets Uncoated Fibreglas, 1x1m	70
J2712 Welding Blankets Uncoated Fibreglas, 1x2m	70
J2713 Welding Blankets Uncoated Fibreglas, 2x2m	70
J2714 Welding Blankets Uncoated Fibreglas, 3x2m	70
J2715 Welding Blankets Uncoated Fibreglas, 1x25m	70
J2716 Welding Blankets Fiberglass PU Coated, 1x1m	70
J2717 Welding Blankets Fiberglass PU Coated, 1x2m	70
J2718 Welding Blankets Fiberglass PU Coated, 2x2m	70
J2719 Welding Blankets Fiberglass PU Coated, 2x3m	70
J2720 Welding Blankets Fiberglass PU Coated, 1x25m	70
J2721 Welding Blankets Fiberglass Vermiculite, 1x1m	71
J2722 Welding Blankets Fiberglass Vermiculite, 2x1m	71
J2723 Welding Blankets Fiberglass Vermiculite, 2x2m	71
J2724 Welding Blankets Fiberglass Vermiculite, 3x2m	71
J2725 Welding Blankets Fiberglass Vermiculite, 1x25m	71
J2726 Welding Blankets Silica Uncoated, 1x1m	71
J2727 Welding Blankets Silica Uncoated, 1x2m	71
J2728 Welding Blankets Silica Uncoated, 2x2m	71
J2729 Welding Blankets Silica Uncoated, 3x2m	71
J2730 Welding Blankets Silica Uncoated, 1x25m	71
J2741 Magnifying Lens 1.0 Clear	63
J2742 Magnifying Lens 1.25 Clear	63
J2743 Magnifying Lens 1.5 Clear	63
J2744 Magnifying Lens 1.75 Clear	63
J2745 Magnifying Lens 2.0 Clear	63
J2747 Magnifying Lens 2.5 Clear	63
J5032 WH30 ALBATROSS Welding Helmet with Shade 10 MG	42, 43
J5205 R60 Airmax Elite PAPR system	25
J5223 Airmax Elite Exchangable battery	25
J5224 WH70 BH3 AIR PAPR for INT ADF	25
J5225 WH70 BH3 AIR PAPR Grand GDS	25
J5226 WH70 BH3 AIR PAPR Grand DS	25
J5227 WH70 BH3 AIR PAPR Grand ES	25
J5229 WH70 BH3 AIR PAPR for EXT ADF	25

Product No	Page
J5233 Concept hard hat	25, 37, 57
J5234 Hard hat adaptor set	25, 57
J5237 370 sweat band for WH70	25, 57
J5238 WH70 Standard face seal	25
J5241 PAPR FR Hose Cover	15, 17, 19, 21, 23, 27, 29
J5243 Hard hat sweat band	25, 57
J5251 F50 Visor Face Seal	27
J5252 F50 Visor Lens	27
J5254 Airmax Elite Comfort padded belt	25
J5255 Airmax Elite Light flexi hose	25
J5256 Airmax Elite Battery charger	25
J5257 Airmax Elite Particle filters P R SL	25
J5258 Airmax Elite Chemical filter A1 P R SL	25
J5259 Airmax Elite Pre-filter	25
J5262 Airmax Elite Spark arrester	25
J5264 Airmax Elite Chemical filter A1B1E1 P R SL + ozone	25
J5462 F50 PAPR Sweat Band	27
J7050 AIRMAX PAPR System with Duo Welding Helmet 4/9-13 ADF	15
J7051 WH25 DUO PAPR Welding Helmet with 4/9-13 ADF	41
J7060 WH25 DUO PAPR Sweatband	29, 41
J7061 WH25 DUO PAPR Faceseal	15, 41
J7062 WH25 DUO PAPR Head Gear	41
J7063 AIRMAX Welding PAPR FR Hose & Cover	15
J7064 Hose without cover, 85 cm	17, 29
J7065 AIRMAX Welding PAPR Motor	15
J7067 AIRMAX Welding PAPR Charger	15
J7068 AIRMAX Welding PAPR 4C Battery	15
J7069 AIRMAX Welding PAPR Waist Belt	15
J7101 WH25 DUO Welding Helmet with 4/9-13 ADF	41
J7165 WH05 FLIP Protective Lens 110 x 60 mm Cover Lens	35
J7166 WH05 FLIP Protective Lens 108 x 51 mm Cover Lens	35
J7167 WH05 FLIP Protective Lens 110 x 90 mm Cover Lens	35
J7172 WH25 DUO ADF Cradle	41
J7173 WH25 DUO Welding - Lens Retainer	41
J7174 WH25 DUO Welding Head Gear Pro	41
J7175 WH25 DUO Sweat Band Pro	41
J7176 WH25 DUO Front Cover Lens	41
J7177 WH25 DUO Inner Cover Lens	41
J7179 FLIP EYEWEAR INSIDE COVER LENS	35
J7180 DUO ADF 4/9-13	41, 65
J7187 WH05 FLIP Welding Helmet 110x60mm	35
J7188 WH05 FLIP Welding Helmet 110x90mm	35
J7189 WH05 FLIP Welding Helmet 108 x 51 mm	35
J7210 AIRMAX Welding P3 PAPR Filter	15
J7260 F50 PAPR Head Gear	27
J7261 F50 PAPR Face Shield	27
J7265 AIRMAX+ with F50 Face Shield	27
J7910 WH25 DUO Weld Helm Spacer Kit	41
J8003 WH50 MULTIVIEW IR/UV5 replacement shell for INT ADF	47
J8010 WH40 ADVANTAGE with WF40 4/9-13 TN INT ADF, blue	44, 45, 46
J8011 WH40 ADVANTAGE Welding Helmet for INT (w/o ADF), blue	45
J8016 WH40 ADVANTAGE Welding Helmet for INT (w/o ADF), silver	45
J8019 WH40 ADVANTAGE with WF40 4/9-13 TN EXT ADF, blue	45
J8024 WH50 MULTIVIEW IR/UV5 with WF50 4/9-13 TN INT ADF	47
J8034 WH40 ADVANTAGE with WF40 4/9-13 TN EXT ADF, silver	45
J8049 WH20 ASPIRE Welding Helmet with WF20 4/9-13 EXT ADF	39
J8070 WH10 FLIP-UP Welding Helmet with Shade 10 MG	37
J8101 WF10 Welding Passive Filter 110x90mm Shade 9	62
J8102 WF10 Welding Passive Filter 110x90mm Shade 10	62
J8103 WF10 Welding Passive Filter 110x90mm Shade 11	62
J8104 WF10 Welding Passive Filter 110x90mm Shade 12	62
J8162 WF40 SM INT ADF	45, 67
J8172 WF50 SM INT ADF	47, 67
J8181 WF20 TN INT 3/10 ADF	67
J8183 WF20 TN INT 3/11 ADF	67
J8187 WF40 TN INT ADF	45, 67
J8190 WF40 TN EXT ADF	45, 67
J8191 WF50 TN INT ADF	47, 67
J8301 Outer lens 110 x 97 mm	45
J8302 Inner lens 107x51mm	39, 43, 45
J8303 Inner lens 109 x 66 mm	47

Product No	Page
J8304 Inner lens 110 x 90 mm	43
J8319 Outer lens 115x104mm	39
J8327 Inner lens 104 x 53 mm	47
J8328 Inner lens 103.5 x 47 mm	45
J8333 PRO head gear	43, 45, 47
J8338 Outer lens 142.4 x 89.2 mm	47
J8342 WH10 Flip up lid 110x60 mm	37
J8346 WH30 Albatross Lens retainer for passive filter black	43
J8347 WF10 Mineral glass 110x60mm Shade 10 Filter	37, 62
J8348 Outer lens 110x60 mm	37
J8353 WH30 Albatross Welding visor clear	43
J8354 Outer lens 107 X 87 mm	43
J8356 WF10 Mineral glass 110x60mm Shade 9 Filter	37, 62
J8357 WF10 Mineral glass 110x60mm Shade 11 Filter	37, 62
J8358 WH50 Multiview Side windows RL	47
J8359 WF10 Mineral glass 110x60mm Shade 12 Filter	37, 62
J8361 WH40 Advantage Replacement Front Bezel Plate, Silver	45
J8362 WH40 Advanatage Replacement Front Bezel Plate, Black	45
J8370 WH20 Aspire Head gear with sweatband	39
J8570 370 head gear for WH70	25, 57, 59
J9912 WH70 Replacement shell for INT ADF	57
J9913 WH70 Replacement shell for EXT ADF	57
J9914 WH70 Welding Helmet with Grand DS ADF	57
J9915 WH70 Welding Helmet with Grand ES ADF	57
J9916 WH70 Welding Helmet with Grand GDS ADF	57
J9927 WF70 GDS ADF	67
J9928 WF70 ES ADF	67
J9929 WF70 DS ADF	67
J9931 Outer lens 147x125mm	25, 57
J9932 Inner lens 107.5x71.5mm	25, 57
J9933 WH70 Flexi face seal	25
J9934 WH70 Washer set	25, 57
J9935 Hose holder	25
J9936 Mag lens holder	25, 57
J9940 Flip front kit 110x90 mm	25, 57
J9941 Flip front kit 108x51 mm	25, 57
J9942 Leather neck protection	25, 57
K1MID-INT K1 MID-SOLE Intrinsic Ice Cleats	113
K1MID K1 MID-SOLE Original Ice Cleats	113
K1MID-LP K1 MID-SOLE Low Profile Ice Cleats	113
S72000 XP410 glasses, clear, HC/AF	99
S72001 XP410 glasses, smoke, HC/AF	99
S72300 XP450 glasses, clear, HC/AF	98, 99
S72301 XP450 glasses, smoke, HC/AF	99
S72400 XP460 glasses, clear, HC/AF	99
S72401 XP460 glasses, smoke, HC/AF	99
S74751 B5 glasses, shade 5 IR	94
S76301 Sebring glasses, black	94
S80200 Odyssey II Series Industrial Dual Lens Goggle	93
S80201 Odyssey II Series Chemical Splash Dual Lens Goggle	93
S80210 Odyssey II Series Shade 5 Cutting Goggle	93
S80231 Odyssey II Series Clean Room Goggle	93
V3550170-L/XL Light Industrial Traction Aid - Lg/Xlg	116
V3550170-S/M Light Industrial Traction Aid - Sml/Med	116
V3550270 - S, M, L, XL ALL PURPOSE Traction Aid	118
V3550370-L All Purpose Industrial - Large	115
V3550370-M All Purpose Industrial - Medium	115
V3550370-S All Purpose Industrial - Small	115
V3550370-XL All Purpose Industrial - Oversized	115
V3550470-O/S Heel Traction Aid	114
V3550570-L Heavy Duty Traction - Large	117
V3550570-M Heavy Duty Traction - Medium	117
V3550570-S Heavy Duty Traction - Small	117
V3550570-XL Heavy Duty Traction - Oversized	117
V3551270 - L/XL, S/M Everyday G3 Traction Aid	118
V3551370 - L/XL, S/M Everyday Pro Traction Aid	118
V4550150-O/S Foot Rubz Ball	118
V4550250-O/S Foot Massage Roller	118
V4550350-O/S Full Body Massage Tool	118

WARRANTY TABLE

Product	Years
ADFs	
Duo ADF	1
Solera 110 x 90 mm ADF	2
Solera 110 x 60 mm ADF	2
Solera 108 x 51 mm ADF	2
Translight 355 ADF	3
Translight 455 ADF	3
Translight 555 ADF	3
Rebel ADF	2
WF20 ES ADF	1
WF20 TN INT 3/10 ADF	1
WF20 TN INT 3/11 ADF	1
WF40 SM INT 4/9-12 ADF	3
WF40 TN EXT 4/9-13 ADF	1
WF40 TN INT 4/9-13 ADF	1
WF50 SM INT 4/9-12 ADF	3
WF50 TN INT 4/9-13 ADF	1
WF70 DS 4/9-13 ADF	5
WF70 ES 4/9-13 ADF	5
WF70 GDS 4/6-8/9-13 ADF	5

WELDING HELMETS

Helmet Shells	3
---------------	---

PAPR SYSTEMS

AIRMAX	
Blower Unit	1,5
Battery	1
AIRMAX+	
Blower Unit	1,5
Battery	1
AIRMAX ELITE	
Blower Unit	1,5
Battery	1

NEW PACKAGING



New packaging will help the program stand out and drive sales.

Standard Terms & Conditions of Sale – Jackson Safety Europe

1. General

"Jackson Safety", "JS", "we", "us": Balder Ltd., a limited liability company registered in Slovenia and doing business as Jackson Safety, with a head office located at Teslova ulica 30, 1000 Ljubljana, Slovenia.

"Buyer": The legal entity to whom we supply goods (collectively "Products") of any kind.

Except insofar as otherwise explicitly agreed in writing between Jackson Safety and the Buyer, these Standard Terms & Conditions (the "Conditions") will apply to all transactions between JS and the Buyer, whether this is done in writing, via the internet, electronically or verbally (each a "Contract").

2. Shipment agreements

2.1 An agreement with JS to supply Products is only established when JS has confirmed in writing a Buyer purchase order within 8 days following its receipt. Any amendments must be confirmed in writing by JS.

2.2 Any purchase order not confirmed in writing by JS shall be null and void.

3. Terms of delivery and transportation

3.1 The method of transport shall be determined by JS if not specified by the Buyer. Any specific requirements of the Buyer on the transport and shipment will only be performed if the Buyer has declared that it will bear the additional costs.

4. Time of delivery

4.1 The periods stated for delivery are not binding and are only target dates. Failure to meet the requested time of delivery does not in any event, provide grounds for

the cancellation of an order or agreement, nor does it entitle the Buyer to any kind of compensation. We explicitly reserve the right to deliver by instalments, each of which will qualify as partial sale. The delivery of an order by instalments cannot in any event justify the refusal to pay for the Products supplied. Any liability on the part of JS for failure or delay in delivery is hereby excluded.

5. Liability

5.1 In the event that the Products supplied are damaged or incomplete, or in the event of any error, missing piece or any other type of irregularity, the Buyer is obliged to refuse the Products on delivery or to only accept them subject to a written reservation. Every complaint relating to the Products as delivered must be sent to us in writing within 5 working days as from the receipt, with a reference to the bill of lading. After that period, the Products will be deemed to have been finally accepted by the Buyer. No goods may be returned without prior written permission from JS. Such permission will not in any way imply that the Products have been acknowledged by JS as being damaged. Goods being returned, in whatever way they are being sent, remain at the Buyer's risk and will be sent to our warehouse, carriage free.

5.2 JS shall not be liable for or responsible for any defect or other claim which arises from (i) normal wear and tear, misuse, negligence, accident, abuse, use not in accordance with standards of proper practice or normal usage conditions set out in the catalogues, manuals or handbooks supplied by JS, modification or alteration not authorized in writing by JS, or use in conjunction with a third party product, or (ii) Buyer's negligence, or (iii) the breach of Buyer's obligations under this Agreement.

6. Delivery and risks

6.1 Delivery is regarded as being complete on the moment of departure from our

A / Une / Eine / Una / La



Brand / Marque / Marke / Marca

Ordering E-mail sales@jacksonsafety.eu

Customer Service +386 1 477 67 84

www.jacksonsafety.eu

NEW STORIES



JACKSON®

SAFETY

warehouse loading dock. The Products always travel at the Buyer's risk, even if they are being sent carriage free. The risk of loss, damage or destruction of the goods to be supplied by JS is borne by the Buyer from the moment that these goods are delivered in accordance with this article.

7. Force majeure and hardship

7.1 All delivery and other obligations of JS will be suspended in the event of force majeure. In such cases, JS is only obliged to deliver or perform its obligations to the extent possible. 'Force majeure' includes the following, although this is not an exhaustive list: war, mobilization of troops, embargo, partial or complete strike, lock-out, riot, epidemics, natural disasters, import and export restrictions, machinery failure, staff sickness, fire, explosion, accidents of any kind and any cause hampering the normal supply by our suppliers of raw materials, fuels and inventory for our normal production, transportation or dispatch, as well as all similar circumstances affecting JS, its subcontractors or suppliers.

8. Re-sale

8.1 The Buyer may only re-sell the Products in their original packaging, without modification.

9. Payments

9.1 All amounts due to JS are payable within 30 days as from the invoice date, without discount, deduction or offset.

10. Compliance with Laws

10.1 Buyer shall comply with all laws and regulations applicable to the storage, use,

handling, installation, registration and labelling of all Products as from their delivery and the disposal of all wastes and residues (including packaging) resulting from your use of the Products.

11. Privacy

11.1 Buyer agrees that JS and entities related with it may collect, store and use Buyer data, including personal data, for the purpose of facilitating its marketing and sale of the Products, and Buyer hereby consents to such collection, storage and use of Buyer data by JS and entities related with it for these purposes.

12. Miscellaneous

12.1 Any provision in these Conditions which is void or inapplicable shall have no effect on the validity of the other provisions. Any invalid clause will be replaced by another one that is appropriate.

12.2 JS may carry out its obligations under the Contract through any agents or sub-contractors appointed by it in its absolute discretion.

13. Applicable law

13.1 All Contracts are deemed executed at the registered office of JS in Slovenia and are governed by Slovenian law. Any dispute concerning the interpretation, implementation and cancellation of the present agreement which cannot be settled amicably will be resolved exclusively by the Courts of Ljubljana. JS may also introduce any proceedings before the courts of the residence of a debtor. The Vienna Sales Convention does not apply.

JACKSON[®]
SAFETY

sellstrom[®]

 **duenorth**[®]

BALDER[®]
TECHNOLOGY

WILSON[®]

CURV-0-MARK[®]

K1 MID-SOLE
SERIES ICE CLEAT



www.jacksonsafety.eu
www.surewerx.com



Follow us on Facebook
SureWerx Europe

A/Une/Eine/Una/La

 **SureWerx**[™]

Brand/Marque/Marke/Marca

USA:
SureWerx USA Inc.,
Elgin, IL, USA 60123
surewerx.com/usa

Canada:
SureWerx, 49 Schooner St.,
Coquitlam, BC V3K 0B3
surewerx.com/ca

Europe:
Balder d.o.o. Teslova ulica 30,
SI-1000 Ljubljana, Slovenia
jacksonsafety.eu

Price 20€ J2021-1 EN



6 26053 61437 9