

# BETA

## Better visibility, better protection

Beta welding helmets provide superb lightweight eye and face protection for all welding, cutting, grinding and inspection purposes. Designed for professional welders and certified to EN175 B, Beta welding helmet range includes either passive or auto-darkening filters.

All Beta models feature the same lightweight but strong shell construction, a comfort headband, GapView flip lens function and magnifying lens frame. When combined with a Kemppi PAPR system, Beta FA models offer TH2 respiratory protection for your lungs.

- Protection for welding, grinding and cutting
- Super lightweight, starting at just 473 g
- Flip-lens with GapView stage position
- Extra protection to face and neck
- ADF and passive lens models
- Comfort headband
- Leather neck protector option
- Magnifying lens frame





# BETA WELDING HELMETS

Designed for professional welders and certified to EN175 B and AS/NZS 1337.1 for welding, grinding and cutting processes, Beta welding helmet range includes three models equipped with either passive or automatic ADF lenses. All Beta models feature the same lightweight but strong shell construction, a comfort headband, GapView flip lens function and magnifying lens frame. The shell design features generous dimensions, providing facial areas excellent protection from arc radiation, whilst allowing good access for tight work-spaces.

## Model options and features

- Beta e90P/e90A/e90X
- For welding, tacking, cutting, grinding and inspection
- Passive or ADF welding lens options
- Beta e90X features XA 47 LiFE+ Color ADF including shades 14 and 15
- Beta e90A features SA 60B LiFE+ Color ADF with 60 cm<sup>2</sup> viewing area
- Deeper protection for facial sides
- Comfort headband
- Light weight – Beta e90P only 473 g
- Magnifying lens option
- See page 46 for models specification



**Beta models feature a range of automatic welding filters, plus optional magnifying lenses.**





# BETA RESPIRATORY MODELS

Beta FA respirators provide cool and clean breathing air, from either a PFU 210e battery powered filter unit offering optimal freedom of movement around the workspace, or a supplied breathing air solution where the air flow is regulated from the RSA 230. Although movement is controlled to a local area, supplied air solutions suit applications where welding and shielding gases may build up displacing the breathing air. Beta FA models are certified with a maximum inward leakage level of 2 % and when connected to the PFU 210e filter unit, offer the option of combined particle and gas filtration.

## Model options and features

- Beta e90 PFA/SFA/XFA
- For welding, tacking, cutting, grinding, inspection
- Battery powered PAPR or airline supplied models
- XFA model features LiFE+ Color ADF technology including shades 14 and 15
- EN 175 B, AS/NZS 1337.1, EN 12941 TH2 and AS/NZS 1716
- Particle and gas filter options
- Fast charging PAPR battery packs
- Leather belt and metal buckle
- Comfort headband
- Light weight – Beta e90 PFA with face seal only 650 g
- Magnifying lens option



**XA 47 features LiFE+ Color technology and shade adjustment 5, 8, 9-13 and 14, 15, plus grinding and cutting modes.**



**SA 60B features LiFE+ Color technology and shade adjustment 3.5, 9-13, plus grinding and cutting modes.**





# PFU 210E

## The best protection for your lungs

PFU 210e means 'Powered Filter Unit with a maximum air speed of 210 liters per minute'. Representing the highest level of filtration performance, PFU 210e is available with both Gamma GTH3 and Beta FA respirator systems, so you can be sure of receiving clean and safe air to breathe.

Robust and durable, PFU 210e offers selectable fan speeds of 160 lpm and 210 lpm, battery and filter status indicators, plus a choice of either standard duty or heavy duty batteries. Lithium-Ion battery technology guarantees fast charging times and the power to protect with either particle filter or a combined filter set with the A1B1E1 gas filter. When A1B1E1 gas filter is in use, Smart Sense technology automatically regulates the PFU 210e to air speed 160 lpm, extending filter and battery lifetime.

- 1 Filter cover
- 2 Spark arrester
- 3 Pre-filter
- 4 Particle filter
- 5 Odor filter: Removes unpleasant odors. Optional accessory. Do not use if a gas filter is present.
- 6 Gas filter: Removes gases and vapors

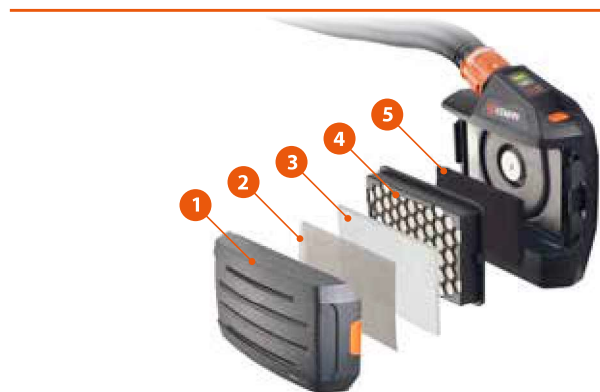

Protection against particles

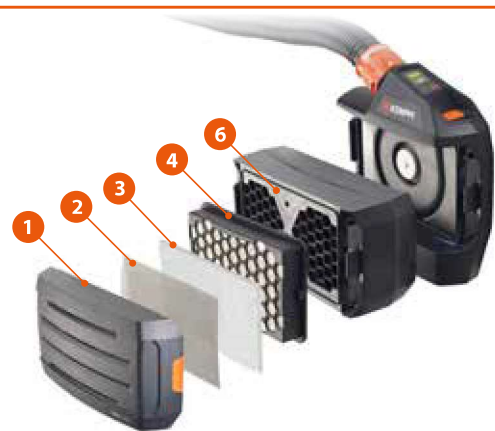

Protection against particles and gas



# FILTERS FOR PAPR

A key component of any respirator is the filter. They are divided into gas, particle and combined filters according to the type of protection they provide. There are standards setting the minimum requirements, test methods and markings for the filters. Gas filters are divided into different types (A, B, E, K etc.) according to the group of substances they are capable of absorbing, and by their absorption capacity they are classified into groups 1, 2 and 3.

Kemppi particle filters in combination with Kemppi PAPR devices provide excellent protection for most welding processes and applications. But your local independent air measurement specialist can provide an air quality report in order for you to accurately select the correct respiratory solution

Kemppi combined filters are divided into gas and particle filters. They have an absorption capacity against organic vapors with boiling points over 65 °C, acid/inorganic gases and vapors, sulfur dioxide. The filtration efficiency is 99,9 % against dust, fumes and mists. Every substance that falls into the above mentioned categories is covered by a Kemppi combined filter set. See the table opposite for further guidance.

For further information regarding standards and approvals please see page 40.



- 1 Filter cover
- 2 Spark arrester
- 3 Pre-filter
- 4 Particle filter
- 5 Odor filter: Removes unpleasant odors. Optional accessory. Do not use if a gas filter is present.
- 6 Gas filter: Removes gases and vapors

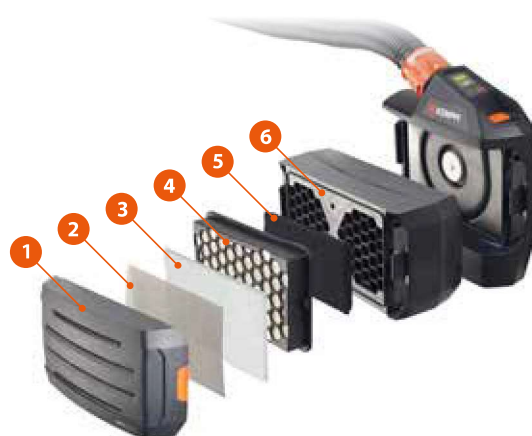

Protection against particles and gas



# BETA e90 PFA + PFU 210e



## Beta e90 PFA + PFU 210e 9873030

Beta e90 PFA welding helmet, shade 11 passive welding filter, powered air respirator PFU 210e , air hose, pre-filter, particle filter, battery 3.2 Ah, battery charger, flow meter, leather belt with comfort padding.

## Spare parts

|                                                  |             |
|--------------------------------------------------|-------------|
| Beta e90 FA welding helmet, ADF excluded         | SP9873004   |
| Protection plate (90 x 110 x 1.0), 10 pcs        | SP9873253   |
| Passive welding filter (shade 11, size 90 x 110) | 9873244     |
| Safety plate (90 x 110 x 1.5), 10 pcs            | SP9873254   |
| Filter retaining spring                          | SP3149850   |
| Headband                                         | SP009023    |
| Sweatband, 2 pcs                                 | SP9873018   |
| Comfort band padding, 5 pcs                      | SP013231    |
| Hatch set                                        | SP015664    |
| Powered air respirator PFU 210e                  | SP011996    |
| Filter cover for PFU 210e                        | SP012095    |
| Spark shield Kemppi, 1 pc                        | SP9320003   |
| Pre-filter, 10 pcs                               | SP9320002   |
| Pre-filter, 100 pcs                              | SP9320002MP |
| Particle filter, 2 pcs                           | SP015757    |
| Particle filter, 5 pcs                           | SP010415    |
| Particle filter, 20 pcs                          | SP010415MP  |
| Gas filter LIFE+                                 | SP009934    |
| Odor filter, 5 pcs                               | SP012223    |
| Air hose                                         | SP012253    |
| Hose protection cover                            | SP010788    |
| Li-ion battery (SD), 3.2 Ah                      | SP012584    |
| Li-ion battery (HD), 6.4 Ah                      | SP012021    |
| Battery charger                                  | SP012426    |
| Flow meter                                       | SP012492    |
| Face seal                                        | SP015537    |

## Welding filters

|          |         |
|----------|---------|
| Shade 8  | 9873241 |
| Shade 9  | 9873242 |
| Shade 10 | 9873243 |
| Shade 11 | 9873244 |
| Shade 12 | 9873245 |
| Shade 13 | 9873246 |

## Magnifying lenses

|                           |         |
|---------------------------|---------|
| Diopter 1.0 (51 x 108 mm) | 9873260 |
| Diopter 1.5 (51 x 108 mm) | 9873261 |
| Diopter 2.0 (51 x 108 mm) | 9873262 |
| Diopter 2.5 (51 x 108 mm) | 9873263 |

## Accessories

|                                     |          |
|-------------------------------------|----------|
| Protective head cover               | W007827  |
| Protective neck cover               | W007828  |
| Universal leather neck protector    | SP015579 |
| Leather welding bib (Alfa and Beta) | SP015177 |
| Leather belt                        | SP010243 |
| Leather belt with comfort padding   | SP012999 |
| Shoulder harness                    | SP011894 |
| Kemppi Tool bag                     | SP010090 |

SP015537

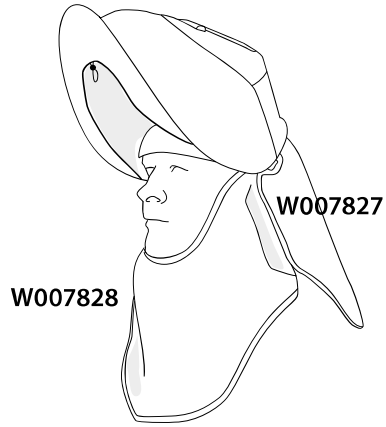

SP9873253

SP015664

9873244

SP3149850

9873260  
9873261  
9873262  
9873263

SP9873254

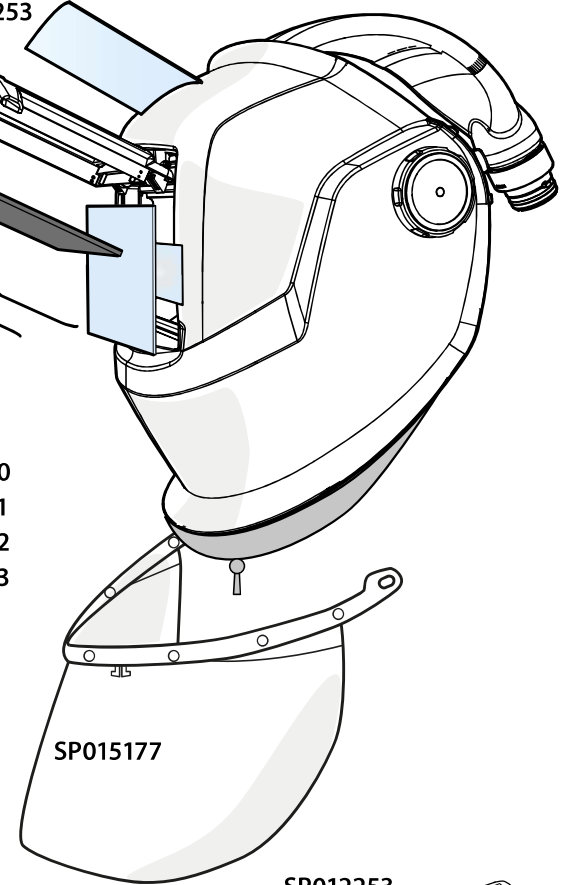

SP9873018

SP009023

SP015177

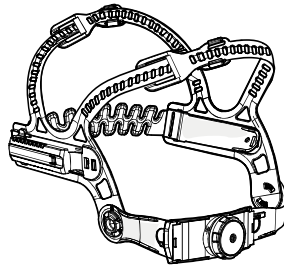

SP012253

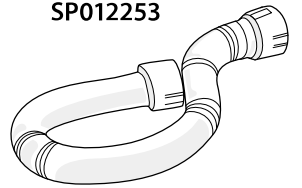

SP010788

SP011996

SP012999

SP010243

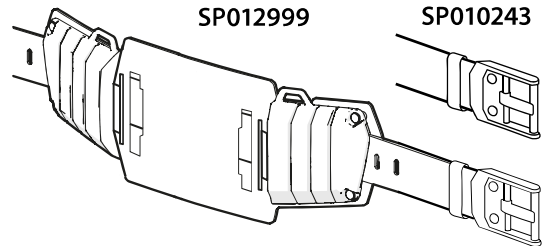
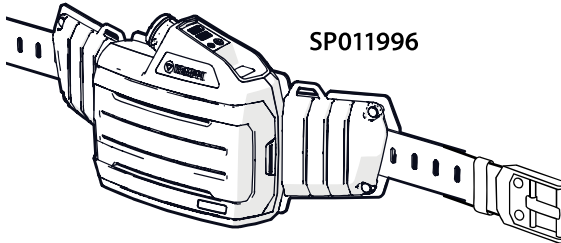
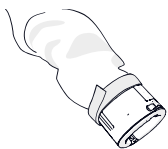

SP012492

SP012095

SP9320003

SP9320002  
SP9320002MP

SP010415  
SP010415MP

SP012223

SP009934

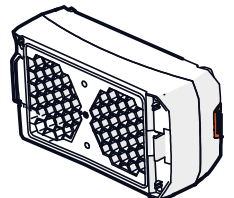
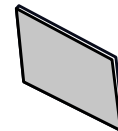
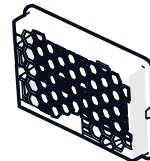
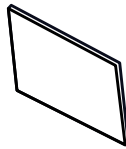
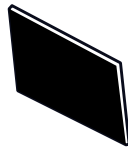
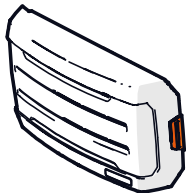
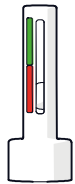

SP011894

SP010090

SP012426

SP012584

SP012021

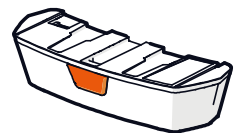
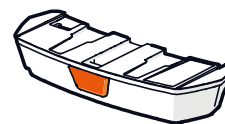
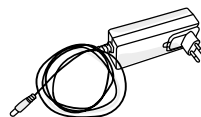
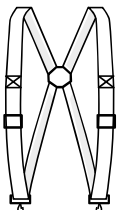

ORDERING CODES