

BETA

Better visibility, better protection

Beta welding helmets provide superb lightweight eye and face protection for all welding, cutting, grinding and inspection purposes. Designed for professional welders and certified to EN175 B, Beta welding helmet range includes either passive or auto-darkening filters.

All Beta models feature the same lightweight but strong shell construction, a comfort headband, GapView flip lens function and magnifying lens frame. When combined with a Kemppi PAPR system, Beta FA models offer TH2 respiratory protection for your lungs.

- Protection for welding, grinding and cutting
- Super lightweight, starting at just 473 g
- Flip-lens with GapView stage position
- Extra protection to face and neck
- ADF and passive lens models
- Comfort headband
- Leather neck protector option
- Magnifying lens frame





BETA WELDING HELMETS

Designed for professional welders and certified to EN175 B and AS/NZS 1337.1 for welding, grinding and cutting processes, Beta welding helmet range includes three models equipped with either passive or automatic ADF lenses. All Beta models feature the same lightweight but strong shell construction, a comfort headband, GapView flip lens function and magnifying lens frame. The shell design features generous dimensions, providing facial areas excellent protection from arc radiation, whilst allowing good access for tight work-spaces.

Model options and features

- Beta e90P/e90A/e90X
- For welding, tacking, cutting, grinding and inspection
- Passive or ADF welding lens options
- Beta e90X features XA 47 LiFE+ Color ADF including shades 14 and 15
- Beta e90A features SA 60B LiFE+ Color ADF with 60 cm² viewing area
- Deeper protection for facial sides
- Comfort headband
- Light weight – Beta e90P only 473 g
- Magnifying lens option
- See page 46 for models specification



Beta models feature a range of automatic welding filters, plus optional magnifying lenses.





BETA RESPIRATORY MODELS

Beta FA respirators provide cool and clean breathing air, from either a PFU 210e battery powered filter unit offering optimal freedom of movement around the workspace, or a supplied breathing air solution where the air flow is regulated from the RSA 230. Although movement is controlled to a local area, supplied air solutions suit applications where welding and shielding gases may build up displacing the breathing air. Beta FA models are certified with a maximum inward leakage level of 2 % and when connected to the PFU 210e filter unit, offer the option of combined particle and gas filtration.

Model options and features

- Beta e90 PFA/SFA/XFA
- For welding, tacking, cutting, grinding, inspection
- Battery powered PAPR or airline supplied models
- XFA model features LiFE+ Color ADF technology including shades 14 and 15
- EN 175 B, AS/NZS 1337.1, EN 12941 TH2 and AS/NZS 1716
- Particle and gas filter options
- Fast charging PAPR battery packs
- Leather belt and metal buckle
- Comfort headband
- Light weight – Beta e90 PFA with face seal only 650 g
- Magnifying lens option



XA 47 features LiFE+ Color technology and shade adjustment 5, 8, 9-13 and 14, 15, plus grinding and cutting modes.



SA 60B features LiFE+ Color technology and shade adjustment 3.5, 9-13, plus grinding and cutting modes.





PFU 210E

The best protection for your lungs

PFU 210e means 'Powered Filter Unit with a maximum air speed of 210 liters per minute'. Representing the highest level of filtration performance, PFU 210e is available with both Gamma GTH3 and Beta FA respirator systems, so you can be sure of receiving clean and safe air to breathe.

Robust and durable, PFU 210e offers selectable fan speeds of 160 lpm and 210 lpm, battery and filter status indicators, plus a choice of either standard duty or heavy duty batteries. Lithium-Ion battery technology guarantees fast charging times and the power to protect with either particle filter or a combined filter set with the A1B1E1 gas filter. When A1B1E1 gas filter is in use, Smart Sense technology automatically regulates the PFU 210e to air speed 160 lpm, extending filter and battery lifetime.

- 1 Filter cover
- 2 Spark arrester
- 3 Pre-filter
- 4 Particle filter
- 5 Odor filter: Removes unpleasant odors. Optional accessory. Do not use if a gas filter is present.
- 6 Gas filter: Removes gases and vapors

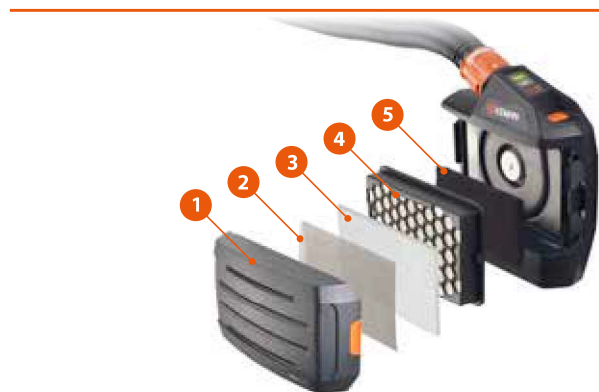

Protection against particles

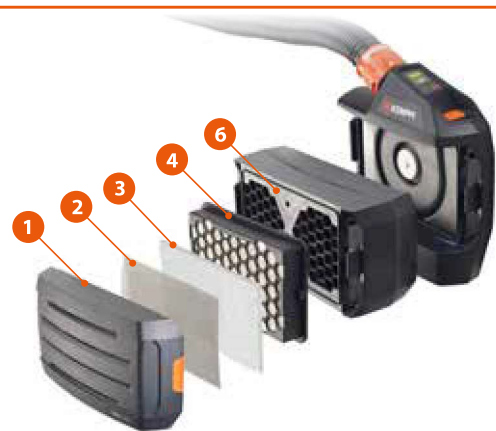

Protection against particles and gas



FILTERS FOR PAPR

A key component of any respirator is the filter. They are divided into gas, particle and combined filters according to the type of protection they provide. There are standards setting the minimum requirements, test methods and markings for the filters. Gas filters are divided into different types (A, B, E, K etc.) according to the group of substances they are capable of absorbing, and by their absorption capacity they are classified into groups 1, 2 and 3.

Kemppi particle filters in combination with Kemppi PAPR devices provide excellent protection for most welding processes and applications. But your local independent air measurement specialist can provide an air quality report in order for you to accurately select the correct respiratory solution

Kemppi combined filters are divided into gas and particle filters. They have an absorption capacity against organic vapors with boiling points over 65 °C, acid/inorganic gases and vapors, sulfur dioxide. The filtration efficiency is 99,9 % against dust, fumes and mists. Every substance that falls into the above mentioned categories is covered by a Kemppi combined filter set. See the table opposite for further guidance.

For further information regarding standards and approvals please see page 40.



- 1 Filter cover
- 2 Spark arrester
- 3 Pre-filter
- 4 Particle filter
- 5 Odor filter: Removes unpleasant odors. Optional accessory. Do not use if a gas filter is present.
- 6 Gas filter: Removes gases and vapors

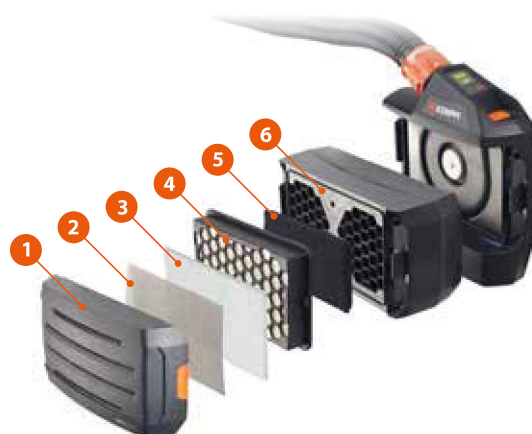

Protection against particles and gas



BETA e90 SFA + PFU 210e



Beta e90 SFA + PFU 210e 9873032

Beta e90 SFA welding helmet with auto-darkening welding filter SA 60B, powered air respirator PFU 210e, air hose, pre-filter, particle filter, battery 3.2 Ah, battery charger, flow meter, leather belt with comfort padding.

Spare parts

Beta e90 FA welding helmet, ADF excluded	SP9873004
Protection plate (90 x 110 x 1.0), 10 pcs	SP9873253
ADF welding filter SA 60B (shades 9-13, viewing area 100 x 60)	SP9873064
Inner protection plate for SA 60B (106 x 65), 5 pcs	SP012425
Safety plate (90 x 110 x 1.5), 10 pcs	SP9873254
Filter retaining spring	SP3149850
Headband	SP009023
Sweatband, 2 pcs	SP9873018
Comfort band padding, 5 pcs	SP013231
Hatch set	SP015664
Powered air respirator PFU 210e	SP011996
Filter cover for PFU 210e	SP012095
Spark shield Kemppi, 1 pc	SP9320003
Pre-filter, 10 pcs	SP9320002
Pre-filter, 100 pcs	SP9320002MP
Particle filter, 2 pcs	SP015757
Particle filter, 5 pcs	SP010415
Particle filter, 20 pcs	SP010415MP
Gas filter LIFE+	SP009934
Odor filter, 5 pcs	SP012223
Air hose	SP012253
Hose protection cover	SP010788
Li-ion battery (SD), 3.2 Ah	SP012584
Li-ion battery (HD), 6.4 Ah	SP012021
Battery charger	SP012426
Flow meter	SP012492
Face seal	SP015537

Magnifying lenses

Diopter 1.0 (51 x 108 mm)	9873260
Diopter 1.5 (51 x 108 mm)	9873261
Diopter 2.0 (51 x 108 mm)	9873262
Diopter 2.5 (51 x 108 mm)	9873263

Accessories

Protective head cover	W007827
Protective neck cover	W007828
Universal leather neck protector	SP015579
Leather welding bib (Alfa and Beta)	SP015177
Leather belt	SP010243
Leather belt with comfort padding	SP012999
Shoulder harness	SP011894
Kemppi Tool bag	SP010090

SP9873064

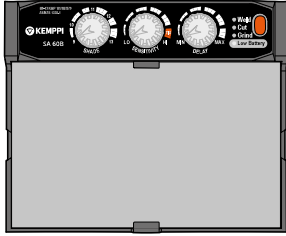

SP9873253

SP015664

SP9873064

SP012425

SP3149850

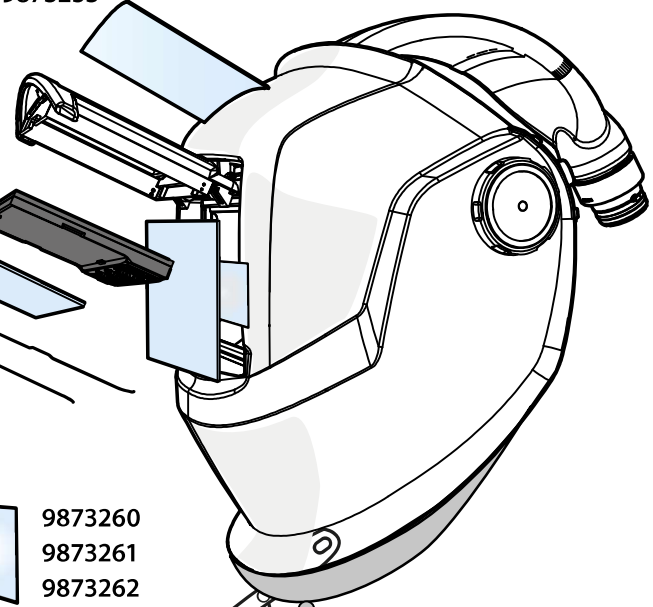

9873260
9873261
9873262
9873263

SP9873254

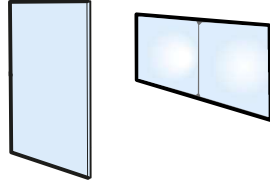

SP015537

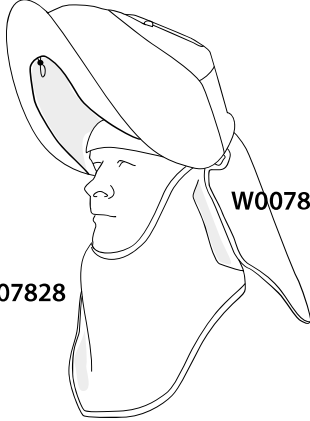

W007827

W007828

SP9873018

SP009023

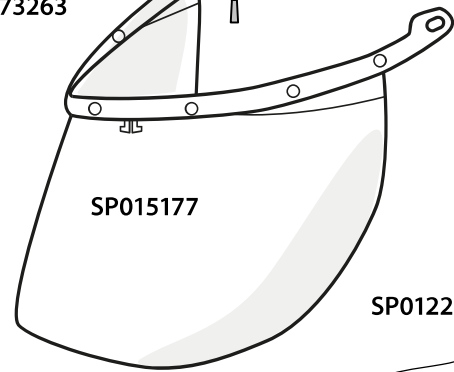
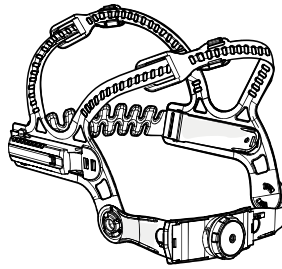

SP015177

SP012253

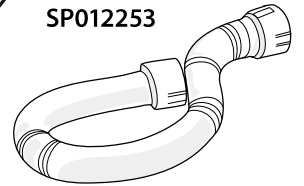

SP015579



SP010788

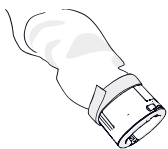

SP011996

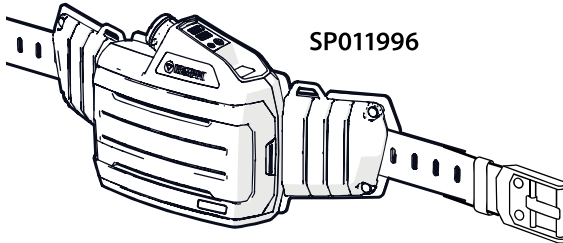

SP012999

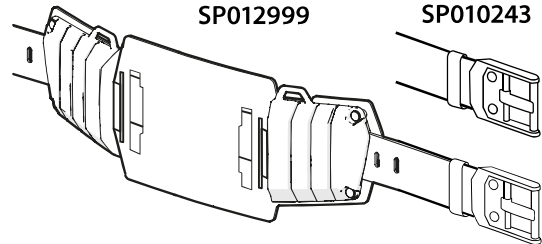

SP010243

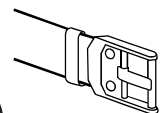

SP012492

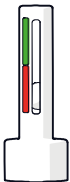

SP012095

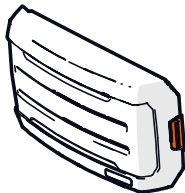

SP9320003

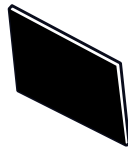

SP9320002
SP9320002MP

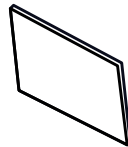

SP010415
SP010415MP

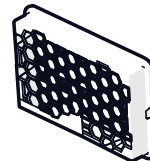

SP012223

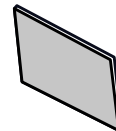

SP009934

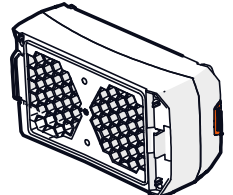

SP011894

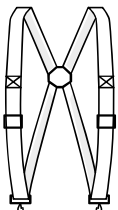

SP010090



SP012426

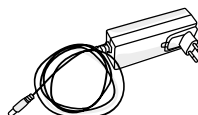

SP012584



SP012021

