

DELTA

Respiratory protection in hard hat working areas

Delta 90 SFA and Delta+ 90 XFA models provide head protection for welding and fabrication personnel working in extreme conditions, such as shipbuilding, heavy fabrication, mining and construction sites.

Delta respirator systems channel clean breathing air over the welder's face from either a rechargeable, Li-Ion battery powered filter pack or locally supplied breathing air source. The adjustable face seal, combined with the 'positive air pressure' design, creates a comfortable breathing zone certified to TH2 European standards, ensuring that 98% of contaminated air remains outside the breathing zone.

- Certified to EN 12941 TH2 and AS/NZS 1716
- Positive pressure design makes breathing effortless
- Li-Ion battery powered filter pack or regulated supplied air breathing system
- Mounting for optional high quality ear defenders





DELTA+ 90 XFA

Maintain respiratory protection during all work processes

Delta+ 90 XFA protects the head, face, eyes and the respiratory system in one high strength unit and includes optional ear defenders. The hinged welding shield raises independently from the large impact rated clear visor, offering exceptional work site views. Ideal for pre and post welding processes, Delta+ 90 XFA maintains the face seal protected, clean breathing air environment.

Delta+ 90 XFA

- Heavy duty hard hat, welding and grinding visor
- Certified EN 397, EN 175 B, AS/NZS 1801 and AS/NZS 1337.1
- XA 47 ADF welding filter, shades 5 / 9-13 / 14-15
- Li-ion battery powered filter pack or supplied air packages
- Remain protected behind the large, clear impact rated visor



Lightweight, belt mounted, powered filter pack with Li-ion battery.





FA FLOW CONTROL

Efficient, lightweight and compact

FA Flow Control is a battery powered filter unit with adjustable motor fan speeds from 140 lpm to 210 lpm. Powered from a Li-ion battery pack and providing protection against particulate contaminants associated with welding and fabrication operations, FA Flow Control offers excellent freedom of movement and breathing protection.

FA Flow Control unit

- 140 lpm to 210 lpm air flow regulation
- Status indicators for motor speed, battery and filter
- Li-ion rechargeable battery pack
- Excellent freedom of movement in the workplace
- Supports Delta/Delta+ models only



Filter cover, particle filter and motor unit.



DELTA+ 90 XFA

+ FA Flow Control



Delta+ 90 XFA + FA Flow Control 9873320

Delta+ 90 XFA welding helmet, auto-darkening welding filter XA 47, air hose, FA Flow Control unit, Li-ion battery and charger, flow meter, comfort belt.

Spare parts

Delta+ 90 XFA welding helmet	9873069
Protection plate, 10 pcs	W007520
ADF welding filter XA 47 (shades 9-15, size 90 x 110)	SP9873063
Inner protection plate for SA 47 / XA 47 (104 x 54), 5 pcs	SP012952
Welding visor	W009234
Grinding visor	W009233
Fixing screws, 2 pcs	W007518
Headband	W007519
FA Flow Control unit with Li-ion battery	W013560
Filter cover for FA Flow Control	W013565
Basic filter, 2 pcs	W007490
Sealing ring for FA Flow Control	W007491
Pre-filter for FA Flow Control, 10 pcs	W007492
Odor filter for FA Flow Control, 10 pcs	W007494
Air hose	W007487
Hose protection cover	W007788
Li-ion battery, 4.4 Ah	W007507
Li-ion battery charger	W013564
Flow meter	W007488

Magnifying lenses

Diopter 1.0 (51 x 108 mm)	9873260
Diopter 1.5 (51 x 108 mm)	9873261
Diopter 2.0 (51 x 108 mm)	9873262
Diopter 2.5 (51 x 108 mm)	9873263

Accessories

Face seal	W007516
Protective head cover	W007827
Protective neck cover	W007828
Ear muffs, no 12	W007517
Comfort belt	W007489
Heavy duty comfort belt	W007789
Kemppi Tool bag	SP010090

W007520



SP9873063

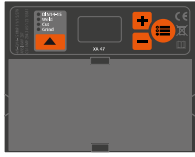

SP012952

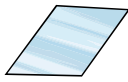

W009234

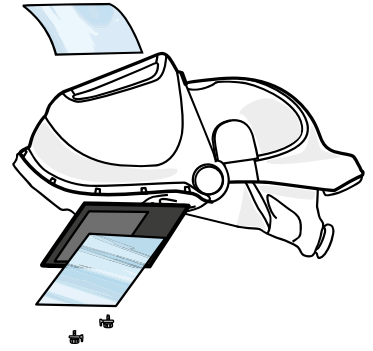
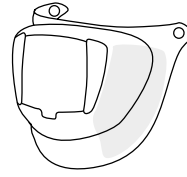

9873260

9873261

9873262

9873263

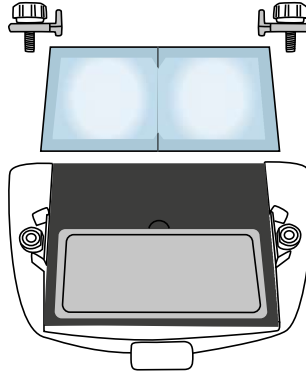

9873069

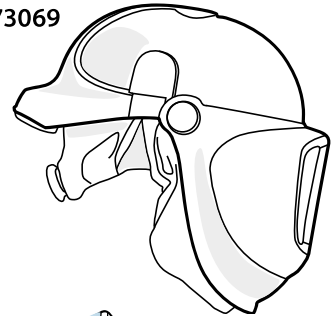

W007519

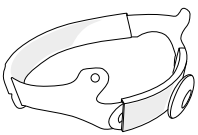

W009233

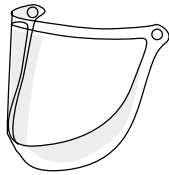

W007518



W009233

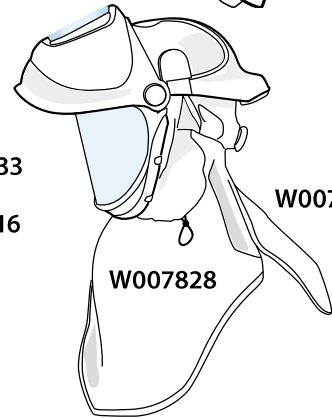

W007827

W007517

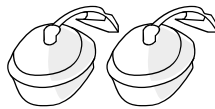

W007516

W007828

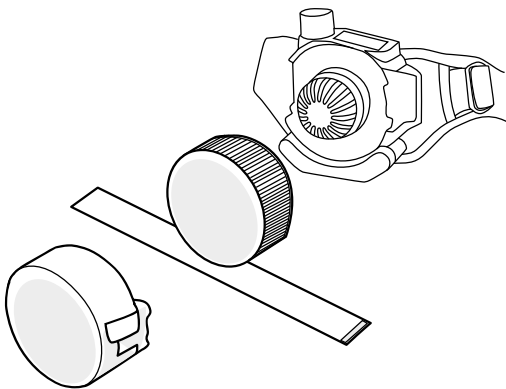

W013565

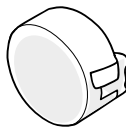

W007490

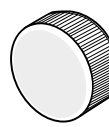

W007491

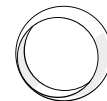

W007492
W007494

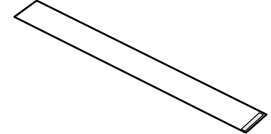

W007788

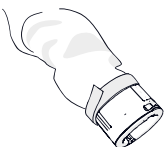

W007487

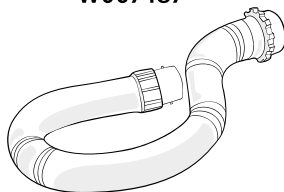

W007789

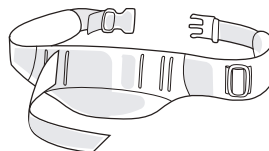

W007489

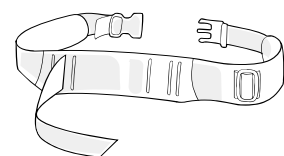

SP010090



W007488



W007507

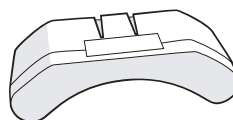

W013564

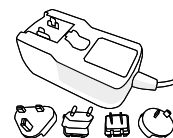

ORDERING CODES