

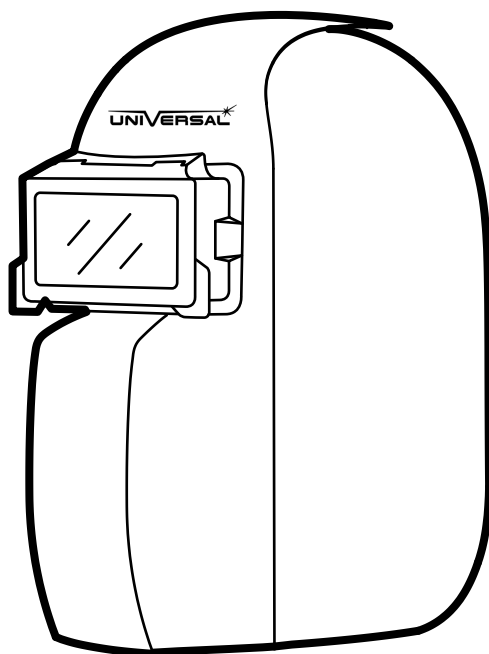

## FORGE FLEX

### Flip-up Leather Welding Mask

### User Manual



#### Applicable model

- SHADE GLASS DIN 8,9,10,11,12
- ADF DIN 8-13



## SAFETY WARNINGS - READ BEFORE USING



### WARNING

Read & Understand All Instructions Before Using



The Universal Forge Flex series flip-up leather welding masks are designed to protect the eyes and face from sparks, spatter and harmful radiation under normal welding conditions.

The flip-up leather welding masks comes un-assembled. A welding filter of choice must be fitted. Before use, it must be adjusted properly. Check battery surfaces and contacts and clean it if necessary. Verify if the battery is in good condition and installed properly. Set up for delay time, sensitivity and shade number for your application(For ADF 8-13).

The flip-up leather welding masks should be stored in dry, cool and dark area. Remove the battery when not using it for long time (For ADF 8-13 only).



### WARNING

In order to protect wearer, correct selection, training, use and maintenance of product are very necessary, please read instructions before using this product.



- Use of this product for other operations, such as laser welding/cutting, may cause permanent eyes injury and visual loss.
- Materials in contact with skin may cause skin allergic reactions in a small number of people.
- Do not make any modifications to either the filter or mask, unless specified in this manual. Do not use replacement parts other than those specified in this manual. Unauthorized modifications and replacement parts will void the warranty and expose the operator to the risk of personal injury.
- Dispose of waste product parts in accordance with local regulations.



### WARNING

Severe personal injury could occur if the user fails to follow the above mentioned warnings, and/or fails to follow the operating instructions.



## COMMON PROBLEMS AND REMEDIES

### • Irregular Darkening Dimming

Headgear has been set unevenly and there is an uneven distance from the eyes to the filter lens (Reset the headgear to reduce the difference to the filter).

### • Auto-Darkening filter does not darken or flickers

- ① Front cover lens is soiled or damaged (Change the cover lens).
- ② Sensors are soiled (Clean the sensors surface).
- ③ Welding current is too low (Reset the sensitivity level to higher).

④ Check battery and verify they are in good condition and installed properly. Also, check battery surfaces and contacts and clean if necessary. Please refer to the "POWER" on page 3.

• **Slow response**

Operating temperature is too low (Do not use at temperatures below -10 °C or 14 °F).

• **Poor vision**

- ① Front cover lens or the filter is soiled (Change lens).
- ② There is insufficient ambient light.
- ③ Shade number is incorrectly set (Reset the shade number).
- ④ Check if removing the film on the front cover lens.

• **Welding mask slips**

Headgear is not properly adjusted (Readjust the headgear).

**INSTRUCTIONS FOR USE**

WARNING! Before using the mask for welding, ensure that you have read and understood the safety instructions.

• **HEADGEAR ADJUSTMENT**

Adjust the headgear to fit the wearer's head circumference (See fig.1a & fig.1b).

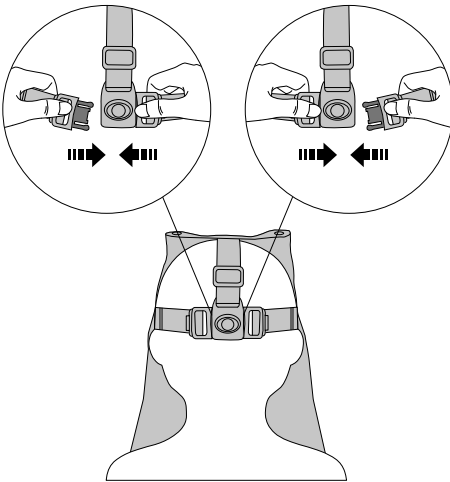

fig.1a

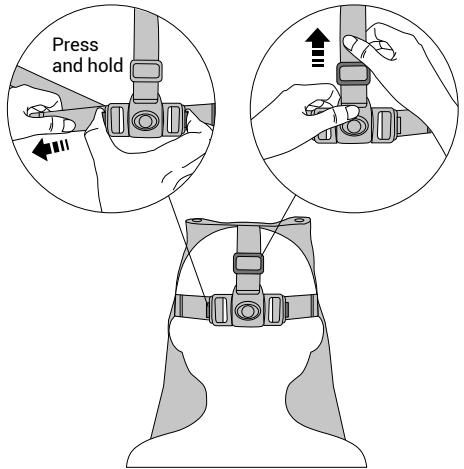

fig.1b

### BEFORE FIRST USE

- 1) The flip-up leather welding masks needs to be charged prior to use and after extended storage. Leave the solar panel on the mask facing the sun or bulb light for at least 1 hours before first use.
- 2) Remove the protective shipping film from both sides of the front lens (if not already done).
- 3) The mask comes assembled, but before it can be used, the headgear must be adjusted for proper fit.

## FORGE FLEX with ADF 8-13

### • BATTERY INSTALLATION

Open the battery cover and install batteries according to positive and negative terminal marking on the battery cover(See fig.2).

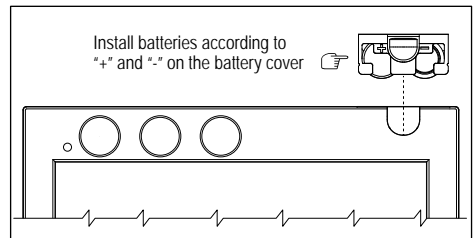

fig.2

### • POWER

This ADF cartridge is powered by solar cell and 2 CR1025 lithium batteries. Replace batteries when **LOW BATTERY** light is lit (See fig.3).

### • SELECTING SHADE LEVEL

Select the shade level you require according to the welding process you will use by referring to the "Shade Guide Table" below for settings. Rotate the shade control knob on the cartridge, white point on knob indicating the level (See fig.3).

### • SENSITIVITY

The sensitivity can be set to "HI" (high) or "LO" (low) by using the infinitely dial knob on the back of the shade cartridge, white point on knob indicating the level. The "Mid-High" setting is the normal setting for everyday use. The maximum sensitivity level is appropriate for low welding current work, TIG, or special applications. Where the operation of the mask is disturbed by excess ambient light, or another welding machine close by, use the "LO" setting. (See fig.3). As a simple rule for optimum performance, it is recommended to set sensitivity to the maximum at the beginning and then gradually reduce it, until the filter reacts only to the welding light flash and without annoying spurious triggering due to ambient light conditions (direct sun, intensive artificial light, neighbouring welder's arcs etc.).

### • SELECTING DELAY TIME

When welding ceases, the viewing window automatically changes from dark back to light but with a pre-set delay to compensate for any bright afterglow on the workpiece. The delay time / response can be set to "S" (short: 0.1 sec.) or "L" (long: 1.0 sec.). As you require using the infinitely dial knob on the back of the shade cartridge, white point on knob

indicating the level (See fig.3). It is recommended to use a shorter delay with spot welding applications and a longer delay with applications using higher currents. Longer delays can also be used for lower current TIG welding, and TIG / MIG / MAG pulse.

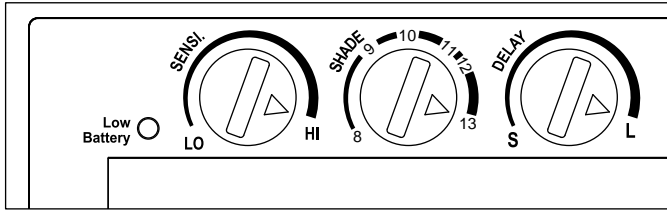

fig.3

**SHADE GUIDE TABLE**

(NO.1)

Welding Process	ARC CURRENT (Amperes)														
	0.5	2.5	10	20	40	80	125	175	225	275	350	450			
	1	5	15	30	60	100	150	200	250	300	400	500			
SMAW					9	10	11	12			13	14			
MIG(heavy)							10	11	12		13	14			
MIG(light)							10	11	12	13	14	15			
TIG,GTAW			9	10	11	12	13				14				
MAG/CO2						10	11	12	13		14	15			
SAW								10	11	12	13	14	15		
PAC								11	12		13				
PAW			8	9	10	11	12	13		14		15			

**NOTE:**

SMAW – Shielded Metal Arc Welding

MIG (Heavy) – MIG on Heavy Metals

PAW – Plasma Arc Welding

SAW – Shielded Semi-Automatic Arc Welding

TIG, GTAW – Gas Tungsten Arc Welding

MIG (Light) – MIG on Light Alloys

PAC – Plasma Arc Cutting

MAG/CO2 - Metal Active Gas

## MAINTENANCE

### • Eye pad replacement

When disassemble the eye pad, tear it off from one end. When replace with new eye pad, fold eye pad in half, align it with middle of back shell and attach it, then unfold it along both sides and attach it to the velcro on back holder (See fig.4).

### • Grind cover lens replacement

Flip up and push out grind cover lens, replace with new lens (See fig.5a/b).

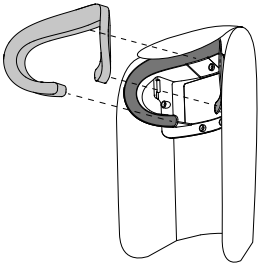

fig.4

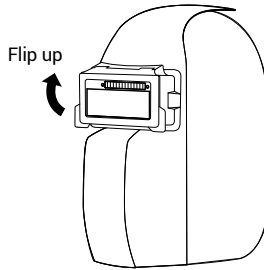

fig.5a

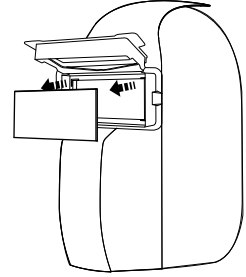

fig.5b

### • Outer cover lens replacement

Remove spring, filter and old outer cover lens, replace with new outer cover lens, install the filter and spring(See fig.6a/b).

### • Inner cover lens replacement(if applicable)

Remove spring, replace with new inner cover lens, install the spring (See fig.6a/b).

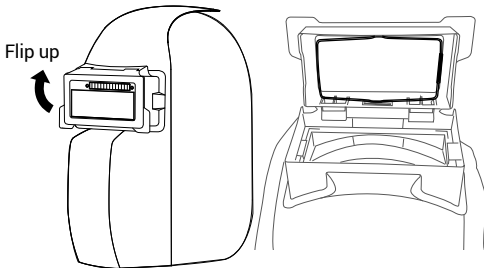

fig.6a

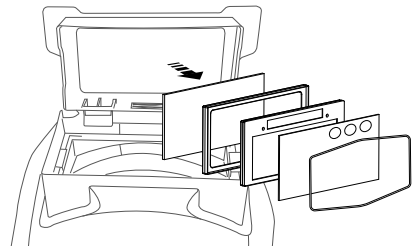
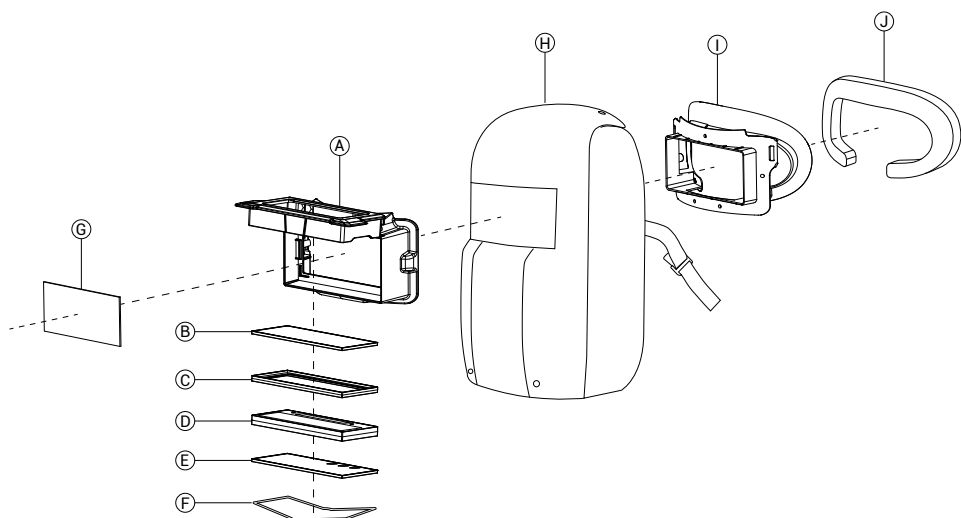

fig.6b

## TECHNICAL SPECIFICATION

MODEL	FORGE FLEX with shade glass (DIN10/11)	FORGE FLEXwith ADF150F (DIN10/11)	FORGE FLEX with ADF 8-13
Optical Class	--	1 / 1 / 1 / 2	1 / 1 / 1 / 2
Viewing Area	95 x 42 mm (3.74" x 1.65")	92 x 35 mm (3.62" x 1.38")	92.1 x 35.1 mm (3.63" x 1.38")
Cartridge Size	--	108 x 50.8 x 5 mm (4.25" x 2.0" x 0.20")	108 x 50.8 x 8 mm (4.25" x 2.00" x 0.31")
Arc Sensor	--	2	2
Light State	--	DIN 3	DIN 3
Dark State	DIN 10 / DIN11	DIN 10 / DIN11	DIN 8 ~ 13
Shade Control	--	--	Internal, Variable Shade
Power On/Off	--	Fully Automatic	Fully Automatic
Sensitivity Control	--	--	Low – High, by infinitely dial knob
UV/IR Protection	Up to Shade DIN16 at all times		
Power Supply	--	Solar cell. Re-chargeable battery No battery change required	Solar cell. Battery replaceable, 2 x CR1025 lithium battery
Low Battery Alarm	--	--	Yes, red light indicator
Switching Time	--	1/4,000 s. from Light to Dark	1/10,000 s. from Light to Dark
Dark to Light	--	0.25 ~ 0.45s	0.1~1.0 s by infinitely dial knob
Low Amperage TIG Rated	--	≥ 35 amps (DC); ≥ 35 amps (AC)	≥ 5 amps (DC); ≥ 5 amps (AC)
Operating Temp.	-20°C ~ +70°C (- 4°F ~ 158°F)	-5°C ~ +55°C (23°F ~ 131°F)	-10°C ~ +55°C (14°F ~ 131°F)
Storing Temp.	-20°C ~ +70°C (- 4°F ~ 158°F)	-20°C ~ +70°C (- 4°F ~ 158°F)	-20°C ~ +70°C (- 4°F ~ 158°F)
Mask Material	Grain leather		
Total Weight	351g	342g	363g
Application Range	Stick Welding (SMAW); TIG DC&AC; TIG Pulse DC; TIG Pulse AC; MIG/MAG/CO2; MIG/MAG Pulse; Plasma Arc Cutting (PAC); Plasma Arc Welding (PAW); Air Carbon Arc Cutting (CAC-A)		
Approved	CE, EN 166, DIN 58214, UKCA, EAC		

## PARTS LIST & ASSEMBLY



### Part List

ITEM	PART NO:	DESCRIPTION	QTY
A	AC629-0000-005	Forge Flex Flip Frame	1
B & G	EP387-0000-041	Forge Flex Front Cover Lens / Viewing Lens (108*50.8*1.5mm) pack of 5	PK 5
C	AC630-0000-005	Forge Flex ADF Cradle	1
D	EP381-0000-005	Forge Flex DIN Glass Shade 8	1
	EP382-0000-005	Forge Flex DIN Glass Shade 9	
	EP383-0000-005	Forge Flex DIN Glass Shade 10	
	EP384-0000-005	Forge Flex DIN Glass Shade 11	
	EP385-0000-005	Forge Flex DIN Glass Shade 12	
	EP386-0000-005	Forge Flex ADF Cartridge 8-13	
E	EP388-0000-041	Forge Flex Inner Cover Lens (passive) pack of 5	PK 5
	EP389-0000-041	Forge Flex Inner Cover Lens ADF 8-13 (109*52*1.0mm) pack of 5	PK 5
F	AC631-0000-005	Forge Flex Retainer Spring	1
H	AC632-0000-005	Forge Flex Replacement Leather Hood	1
I	AC633-0000-005	Forge Flex Inner Eye Frame	1
J	AC634-0000-005	Forge Flex Foam Face Pad (s)	1
	AC635-0000-005	Forge Flex Foam Face Pad (m)	1

1) Optional filters. Refer to actual product.

2) Optional inner cover lens. Refer to actual product.



## WARRANTY

Universal's only obligation shall be repair, replace or refund the purchase price of such parts or products material and fabrication defects free of charge within the warranty period. This warranty does not cover to cause by improper handling abuse or application other than recommended in the user instruction.

If you come across any problem during warranty period, contact your distributor, send the defective parts together with the completed defect problem if necessary.

---

For future reference, please complete the owner's record below:

**Serial Number:**

**Purchase Date:**



DIN EN175:1997  
DIN EN379:2009-07  
(EU) 2016/425  
UKCA-B-210967  
Approved body No: 0194

**UNIVERSAL PPE LTD**

Aqua House, Buttress Way, Smethwick, West Midlands,  
England, B66 3DL  
info@universalppe.co.uk  
Tel: +44 (0) 121 817 7890