

“KAT”[®] CARRIAGE INDEXING SYSTEM

(USING GULLCO GSP CONTROLS)

FOR MODELS:

GK-200-RL*-I - GK-200-FL*-I
GK-200-RM*-I - GK-200-FM*-I
GK-200-RH*-I - GK-200-FH*-I

(indicates voltage reference)*

OPERATING INSTRUCTIONS

Website: www.gullco.com

Distributed by:

GULLCO INTERNATIONAL LIMITED – CANADA

Phone: 905-953-4140

Fax: 905-953-4138

e-mail: sales@gullco.com

GULLCO INTERNATIONAL INC. – U.S.A.

Phone: 440-439-8333

Fax: 440-439-3634

e-mail: ussales@gullco.com

GULLCO INTERNATIONAL [U.K.] LIMITED – EUROPE

Phone: +44 1257-253579

Fax: +44 1257-254629

e-mail: sales@gullco.co.uk

GULLCO INTERNATIONAL PTY LIMITED – AUSTRALIA

Phone: 61 (0) 7 3348-5515

Fax: 61 (0) 7 3348-5510

e-mail: ausales@gullco.com

GULLCO INTERNATIONAL LIMITED – INDIA

Phone: 91-20-65260382

Fax: 91-20-26836656

e-mail: India.io@gullco.com

GULLCO INTERNATIONAL SHANGHAI – LIMITED

Phone: +8621-50460341

Fax: +8621-50463554

e-mail: c.zhang@gullco.com

SAFETY INSTRUCTIONS

Although the Gullco “KAT”[®] carriage indexing system is manufactured for safe and dependable operation, it is impossible to anticipate those combinations of circumstances, which could result in an accident. An operator of the “KAT”[®] carriage is cautioned to always practice "**Safety First**" during each phase of operation, setup and maintenance.

Read and understand the whole Operating Instructions manual (as well as the additional Technical Manual complete with the supplementary GSP Control Manual, “GD-031”) before operating or performing service of this equipment. Become familiar with the machines operation, applications and limitations. Keep the operation manual in a clean and readily available location.

This equipment is normally used to automate / semi-automate welding or cutting processes. These processes usually have any combination of the following; bright and hot arcs, flying sparks, fumes, ultraviolet and infrared radiated energy, hot work-pieces, compressed gases, etc.. The onus is on the operator of this equipment to know, understand and follow all the safety precautions associated with the process being used.

A careless operator invites troubles, and failure to follow safety practices may cause serious injury or even death. Important safety precautions are given in the following:

Electrical Shock Prevention

- Do not use this equipment in damp or wet locations.
- Do not expose this equipment to rain.
- Never carry this equipment by the cables or pull the cables to disconnect from the receptacle.
- Keep all cables from heat, oil and sharp edges.
- Inspect all cables periodically and replace if damaged.
- Inspect the secureness of all cables periodically and repair if loose.
- Disconnect the power cord when not in use.
- Disconnect the power cord **positively** to prevent electrical shock before repair and service of the equipment.

Bodily Injury Prevention

- Do not wear loose clothing, jewellery and loose, long hair, which may get caught into automatic systems or moving parts.
- Ensure that the track is **well** secured when installed in any other position than flat on a surface.
- The track must have a method of safety backup from falling when elevated, i.e., chained at the ends, welded to work-piece, etc.
- Keep lifting handle dry, clean and free from oil and grease.
- Keep hands away from the underside of the “KAT”[®] carriage when there is the slightest possibility of motion.
- Wherever possible, avoid (or at least protect against) objects protruding from the moving equipment, posing possible pinch-points.
- There should only ever be one (1) operator working at the machine at any given time.
- On Flex “KAT”[®] models, the track is made from spring steel. Therefore extreme caution should be exercised with respect to the hazards of injury due to whipping.
- Protective gloves should be worn when handling Flex Track to prevent injury from sharp edges.

SAFETY PRECAUTIONS

The following cautionary/warning label is attached to each “KAT”[®] carriage:-

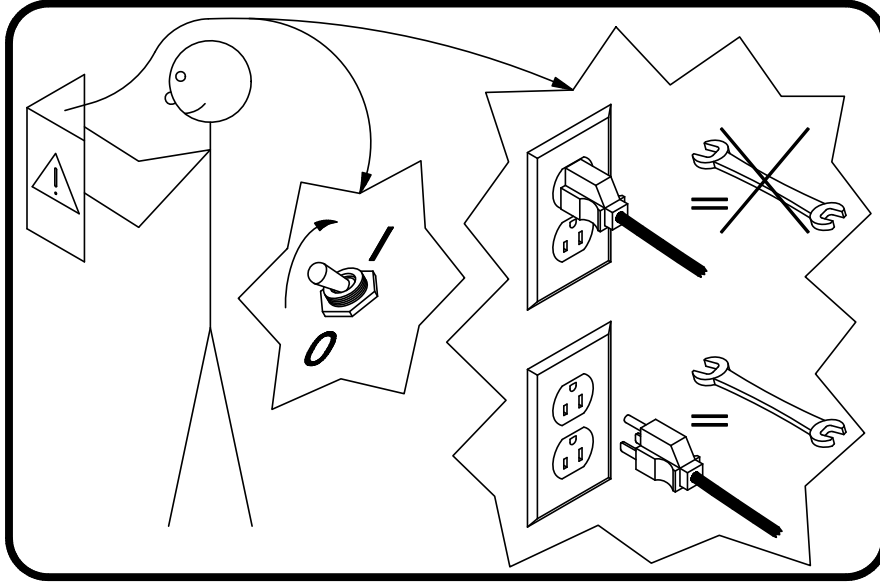

The above label pictorially represents the following:

“Warning:-

*Read the manuals before turning the unit on and before performing service.
Also, positively disconnect the unit from all power supplies before servicing!”*

IMPORTANT

READ THIS BEFORE OPERATING THE “KAT”[®] CARRIAGE INDEXING SYSTEM

When used with electric arc welding or cutting equipment, ensure that an adequate and well-maintained power return path is provided with good electrical contact. Failure to do so may result in the welding/cutting current passing through the carriage and damaging the wiring and electrical components.

Important information regarding safety and operation of the “GSP” motor controls used in the “KAT”[®] carriage indexing system is contained in a supplemental manual attached at the end of the Technical Manual. It is equally important to read, understand and apply the information contained within that manual. The supplemental manual (GD-031) has a title “Technical Information For The Gullco “GSP” Micro-Processor Based, 24 Volt DC Motor Control”, and it’s pages are numbered with a prefix of “T-“.

ALL THE SAFE PRACTICES AND PRECAUTIONS MAY NOT BE GIVEN IN WRITING. SOME ARE BASED ON COMMON SENSE, BUT OTHERS MAY REQUIRE TECHNICAL BACKGROUND TO EXPLAIN.



“KAT”[®] CARRIAGE INDEXING SYSTEM

This manual covers the operating instructions of the following Gullco “KAT”[®] carriage indexing systems, using Rigid or Flex “KAT”[®], all position, variable speed travel carriages (* indicates voltage reference):

GK-200-RL*-I, GK-200-RM*-I, GK-200-RH*-I

GK-200-FL*-I, GK-200-FM*-I and GK-200-FH*-I

GENERAL DESCRIPTION

The Gullco “KAT”[®] indexing system is typically used to automate an overlay/surfacing process. The automatic routine drives a motorized device (either the “KAT”[®] carriage or the motorized rack arm[†]), back and forth between limit switches (cycling). Each time the cycling device reaches a limit switch it pauses while the other motorized device is activated to carry the overlay/surfacing gun/torch a preset distance in a preset direction (indexing). An “Arc Signal Relay” is supplied with the system to provide integrated arc activation signals to the overlay/surfacing equipment. Two GSP controls, each with dedicated microprocessor chips, are used to control the automatic, two axis indexing system. One GSP control is set up to be the “Cycle Control” (master) and the other GSP control is set up to be the “Index Control” (slave). Each control offers user programmable parameters/variables to allow fine-tuning and functional control of the automatic cycle.

The Gullco “KAT”[®] indexing system comprises of a heavy duty, all position “KAT”[®] travel carriage and a motorized rack arm.

The travel carriage is an electrically powered self-propelled carriage that travels in a forward or reverse direction, at precisely controlled speeds, along a special track. The self-aligning wheel system of the carriage grips the top and bottom of the track, enabling it to travel along any plane. The adjustable wheel assembly keeps the carriage snug to the track, while allowing it to be easily mounted and removed from the track at any point. The positive drive of the “KAT”[®] is obtained from either a pinion that engages with the rack of the rigid track, or a uniquely designed sprocket that engages with slots in the flex track. Both of these systems are driven by a low voltage permanent magnet motor and gear-head power unit assembly.

The motorized rack arm consists of a rack arm driven through a motorized rack box. The rack arm is basically a square profile arm with gear racking imbedded along its length. The rack arm is guided through the motorized rack box by Nylastic glide bearings. A low voltage permanent magnet motor and gear-head drive a pinion which engages with the rack of the arm, propelling the arm and ultimately the overlay/surfacing gun/torch, in a straight line.

Safety is greatly enhanced by the use of Gullco’s low voltage (24 V), highly advanced controls and power supply system that is available in three line voltage inputs, i.e. 42, 115 and 230 VAC, single phase, 50/60 Hz, or any unregulated 24 VDC power supply at 220 watts of power. The motors and the controls operate on 24 VDC, supplied by a power supply located within the casing of the “KAT”[®]

[†] This manual makes the assumption that the “KAT”[®] carriage provides the cyclic motion, while the motorized rack box provides the indexing motion. See the diagrams under “Special Reverse Indexing Configuration” in the Technical Manual for details of how to reverse/alternate this arrangement.

carriage. Therefore, all operator interface devices (except the power on/off isolation switch) are subjected to signal level voltages only. Two Gullco GSP motor controls are used; one to drive the “KAT”[®] carriage; and one to drive the motorized rack arm. These microprocessor pulse width modulation motor controls offer operator interface of forward, stop, reverse and infinitely variable control of the speed, within the range of the models, as well as an L.E.D. display indicating travel speeds in either in/min. or cm/min. The travel speeds are electronically controlled using an optical tachometer located on the back of each gear-motor. Through the use of this, closed loop, feedback circuitry, each motor control can obtain accurate and constant speed control of the equipment when running in any plane, regardless of the load (within the rating of the equipment).

INTENDED / FORESEEN USAGE

The Gullco “KAT”[®] carriage indexing system is used throughout the world to automate and improve the quality and efficiency of single or multiple “head” overlay/surfacing operations. Overlay/surfacing guns/torches are readily mounted on the end of the motorized rack arm, which is mounted to the “KAT”[®] perpendicular to its travel direction. The “KAT”[®] track is positioned so that the “KAT”[®] will move the gun (or torch) along the desired path, then usually secured in place using magnetic or vacuum activated mounting devices. With the use of Gullco’s “KAT”[®] carriage indexing system, repetitive overlay/surfacing cycles may be performed, with precise motion of the gun/torch from start to finish, regardless of the number of passes or the work pieces involved. Detrimental factors such as poor or awkward accessibility, operator fatigue, or inconsistent workmanship are eliminated. Required quality levels are consistently attained and productivity and profitability increased.

OPERATION

The electrical and mechanical installation of the “KAT”[®] carriage indexing system is explained in the Technical Manual.

Local Control Devices

The power On/Off switch is used to disconnect the power to the rest of the control circuitry.

I = On, O = Off.

WARNING! The motor control must not be continually started and stopped by the removal and reapplying of power to the control. Turning the power off to the control will not provide instant braking and continued use will damage the control. Allow ten (10) seconds after the removal of power before reapplying the power to the motor control.

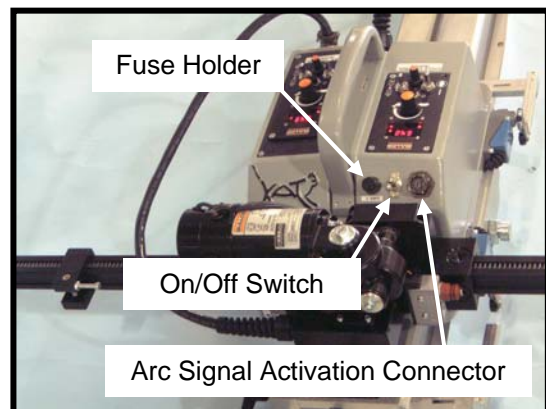

The fuse holder allows accessibility to the main fuse by pushing the cap in towards the main body and twisting in a counter-clockwise direction.

Standard "KAT"® Carriage Indexing System Control Arrangement

Unless specifically requested at time of order, the Gullco "KAT"® Indexer System is shipped from the factory configured with the Cycle Control (Master) located on the left hand side and controlling the "KAT"® carriage, while the Index Control (Slave) is located on the right hand side and controlling the Motorized Rack Arm (refer to the Technical Manual for details of how to reverse this arrangement if necessary).

Label identifying the Cycle Control (Master)
GSP-2010-5
Standard configuration to cycle the "KAT"® Carriage

Label identifying the Index Control (Slave)
GSP-2010-7
Standard configuration to index the Motorized Rack Arm

This section of the label identifies the Programmable Parameters/Variables applicable to the Cycle Control (Master)

This section of the label identifies the Programmable Parameters/Variables applicable to the Index Control (Slave)

Standard configuration = "KAT"® carriage cycles forward & backward between limit switches

Standard configuration = indexing of gun/torch by Motorized Rack Arm at the end of each cycle pass

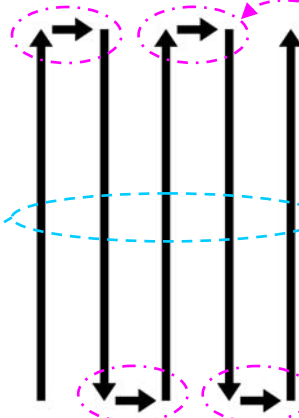
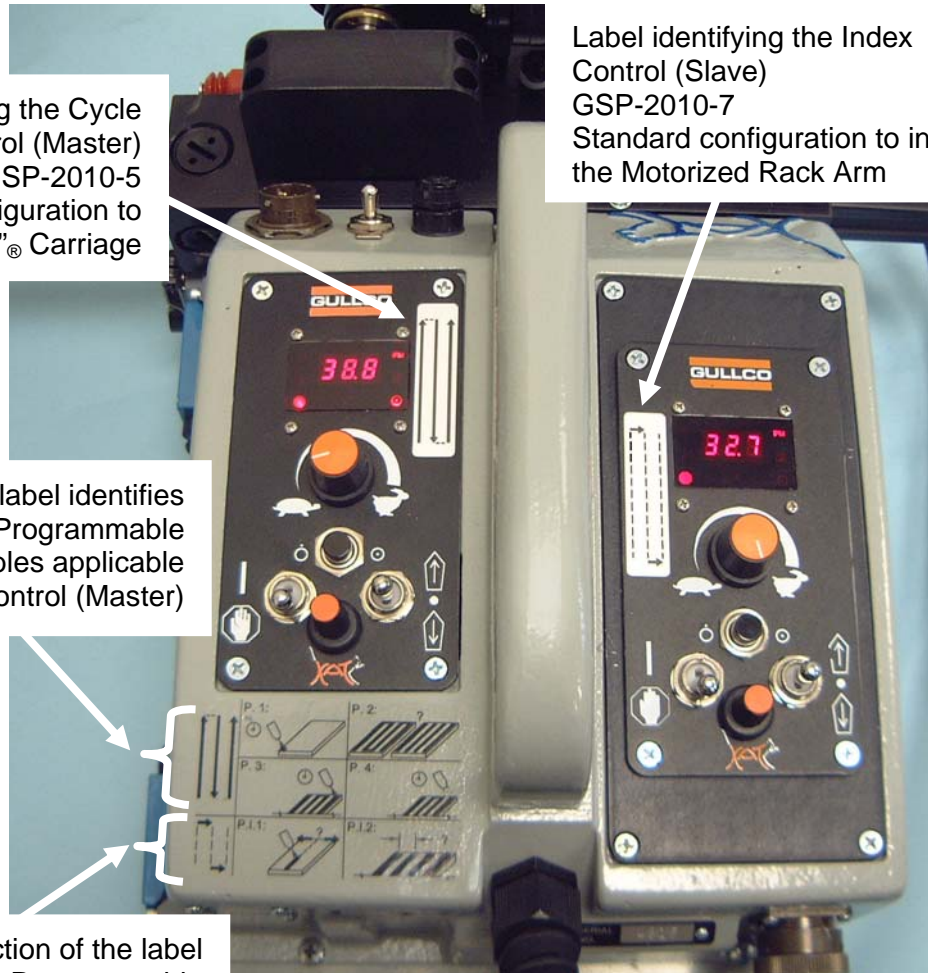

GSP Control Overview

The “KAT”[®] carriage indexing system uses two (2) of Gullco’s sophisticated “GSP” microprocessor motor controls (typically model GSP-2010-5 for the “KAT”[®] carriage and GSP-2010-7 for the motorized rack arm).

“Cycle Control” – This microprocessor control is the Master control and is used to start and stop automatic indexing cycles as well as allowing manual control of the cycling device that is used to generate the repetitive forward and reverse motion (“KAT”[®] carriage[†]). The part number for the Cycle Control micro-processor chip is GSP-2004-5 (The part number for the normal GSP control complete with this chip is GSP-2010-5). This control requires the following connections:

- CN50 – Normal 24 VDC power supply.
- CN21 – Motor leads of the cycling device.
- CN11 – Cycling motor encoder connection.
- CN13 – Cycling forward and reverse limit switch signals.
- CN81 – Arc Signal Relay connection.
- CN84 – Output signal to “Index Control” commanding an index.
- CN12 – Input signals from “Index Control” identifying “ready” status and completion of index.

“Index Control” – This microprocessor control is the slave control and is used to index the overlay/surfacing gun/torch when commanded by the “Cycle Control” (at the end of each cyclic pass), as well as allowing manual control of the indexing device (motorized rack arm[†]). The part number for the Index Control micro-processor chip is GSP-2004-7 (The part number for the normal GSP control complete with this chip is GSP-2010-7). This control requires the following connections:

- CN50 – Normal 24 VDC power supply.
- CN21 – Motor leads of the indexing device.
- CN11 – Indexing motor encoder connection.
- CN13 – Indexing forward and reverse limit switch signals.
- CN84 – Output signal to “Cycle Control” confirming completion of an index.
- CN83 – Output signal to “Cycle Control” confirming “Ready” status.
- CN12 – Input signals from “Cycle Control” commanding gun/torch index.

Externally, the Gullco GSP controls have switching for Forward/Neutral/Reverse and Run/Stop, a Manual/Auto or Full Speed Over-ride (& program variable increment/decrement) push button, a rotary encoder for speed control, as well as a ten position selector switch for programming access to the automatic cycle parameters/variables.

Please refer to the supplemental manual (GD-031) “Technical Information For The Gullco “GSP” Micro-Processor Based, 24 Volt DC Motor Control” (the pages are numbered with a prefix of “T-“), attached at the end of the Technical Manual, for additional, more comprehensive details than those provided in the following overview.

[†] This manual makes the assumption that the “KAT”[®] carriage provides the cyclic motion, while the motorized rack box provides the indexing motion. See the diagrams under “Special Reverse Indexing Configuration” in the Technical Manual for details of how to reverse/alternate this arrangement.

The following graphical labels are applied to the relevant GSP controls to identify their function:

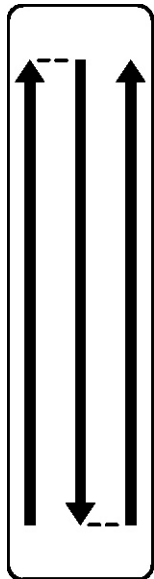

CYCLE CONTROL (Master)
 Drives the motor Forward and Reverse repeatedly between limit switches. Also commands the Arc Signal Relay.

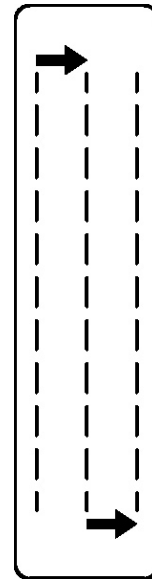

INDEX CONTROL (Slave)
 Drives the motor a programmed distance in the same direction at the end of each cyclic pass.

The following provides a brief description of the GSP controls (refer to the sketch below):

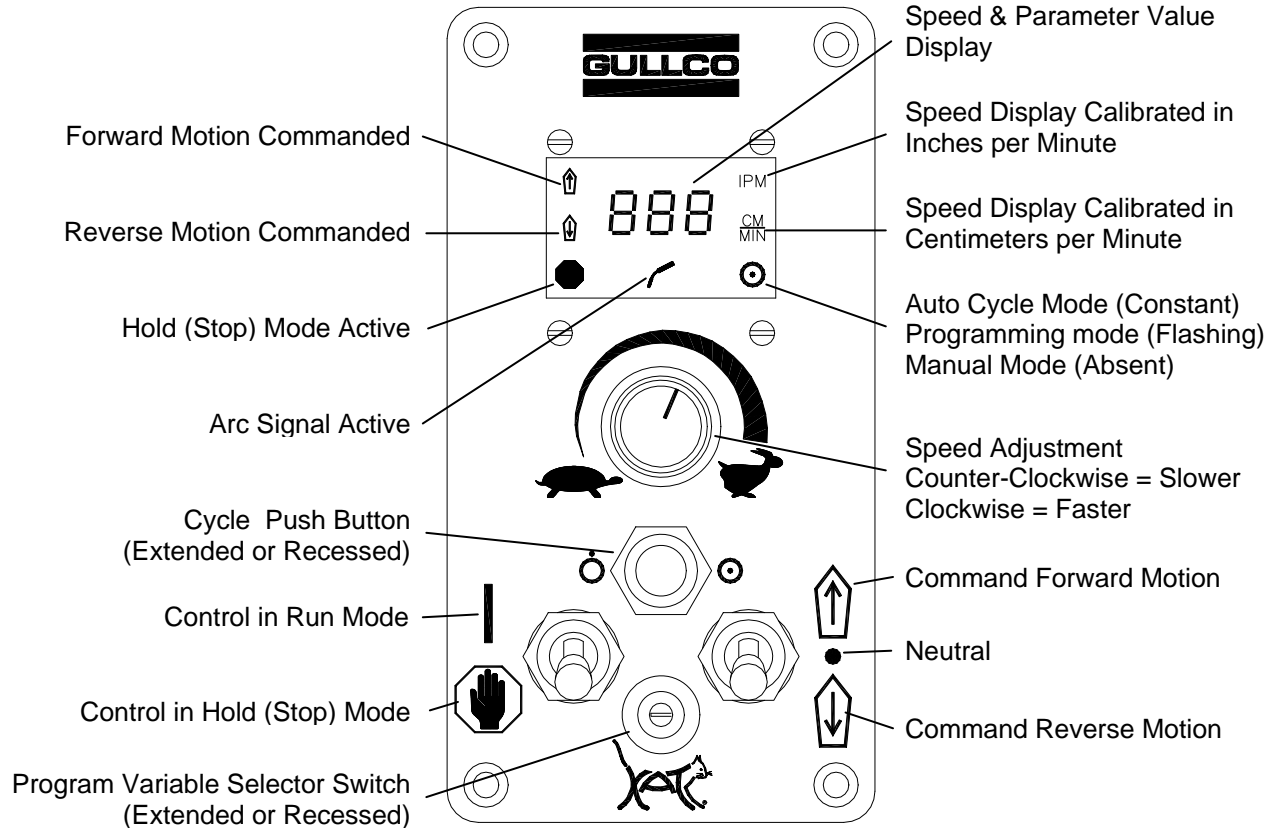

The Cycle Push Button

- For the Cycle Control (Master) - when this momentary device is pressed for one second while the Run/Stop switch is in the Stop position, the control will toggle between Manual Mode (Hnd) and Automatic Mode (Aut). When in Automatic Mode the Auto Cycle Mode LED will be illuminated.
- For the Index Control (Slave) - while ever this momentary device is pressed the travel speed of the indexing device will be set to full.
- *The Cycle Push Button is also used to increment/decrement the values/settings of the program variables (refer to the section “Programming The Automatic Cycle Parameters/Variables” later in this manual for further details of this function).*

The Run/Stop Switch

- For the Cycle Control (Master) - is used to start and stop the “KAT”[®] carriage in Manual Mode and is used to start and stop an automatic cycle in Automatic Mode.
- For the Index Control (Slave) – is used to manually start and stop the motorized rack box and to enable and disable automatic cycles.
- *The Hold (Stop) position is also used to reset most error codes once they have been rectified.*

The Forward/Neutral/Reverse Switch

- For the Cycle Control (Master) - is used to select the “KAT”[®] travel direction desired in Manual Mode and can be used to set the initial travel direction at the start of an automatic cycle.
- For the Index Control (Slave) – is used to select the travel direction desired for a manual jog of the motorized rack arm.
- *The Forward position is used to select increment, while the reverse position is used to select decrement as the method of changing the values/settings of the program variables (refer to the section “Programming The Automatic Cycle Parameters/Variables” later in this manual for further details of this function).*

The Speed Adjustment Knob - is used to increase (clockwise) or decrease (counter-clockwise) the travel speed of the carriage or motorized rack arm, both in Manual Mode and Automatic Mode. The speed display will show the set speed when the Run/Stop switch is in the Stop position and the Forward/Neutral/Reverse switch is in the Neutral position.

The Program Variable Selector Switch – is a ten position rotary switch, used to select the various adjustable parameters that are available to the operator, which determine the functionality and allow fine-tuning of the automatic cycle operation. If requested at time of purchase, a different style of GSP control can be substituted, where the Program Variable Selector Switch is located under a hole plug in the face plate (reducing the possibility of unwanted changes to the automatic overlay/surfacing cycle once set). Refer to the section “Programming The Automatic Cycle Parameters/Variables” later in this manual for further details of this selector switch.

Manual Operation of the Cycle Control (Master)

To toggle between automatic mode (Aut) and manual mode (Hnd), place the Run/Stop switch in the Stop position and press and hold the Cycle Push Button until the desired mode is displayed (Aut or Hnd).

In manual mode (Hnd) the Auto Cycle Mode L.E.D. located in the lower right hand corner of the display will be extinguished (off).

The Forward/Neutral/Reverse switch selects which direction the “KAT”® will travel. The Speed Adjustment knob sets the linear travel speed. When the Run/Stop switch is placed in the Run position, the “KAT”® carriage will travel in the direction and speed set by the Forward/Neutral/Reverse switch and the Speed Adjustment knob. Travel motion will cease if; the Run/Stop switch is placed in the Stop position; the Forward/Neutral/Reverse switch is placed in the Neutral position; the speed is set to zero; or the appropriate travel limit switch is activated in the relevant direction. When limit switch actuation inhibits the commanded travel, the relevant directional LED will flash on and off.

In Manual Mode, the Arc Signal Relay remains de-energized, the signals from the Index Control (Slave) are ignored and the Cycle Control (Master) does not send any signals to the Index Control.

Manual Operation of the Index Control (Slave)

Note: As the Index Control (Slave) does not have selectable automatic and manual modes, the Cycle Push Button is used to activate full speed over-ride of the jog and index speed, while ever pressed.

The motorized rack box can be manually operated, even during an automatic cycle. The Run/Stop switch must be in the Run position to enable manual travel motion. Then, by using the Forward/Neutral/Reverse switch, the indexing device can be driven in the desired direction. The travel speed is set by its speed adjustment knob.

Forward and reverse limit switch activation prevents travel in the relevant direction. When limit switch actuation inhibits the commanded travel, the relevant directional LED will flash on and off.

Automatic Operation

To toggle the Cycle Control (Master) between automatic mode (Aut) and manual mode (Hnd), place the Run/Stop switch in the Stop position and press and hold the Cycle Push Button until the desired mode is displayed (Aut or Hnd). The Index Control (Slave) does not have selectable automatic or manual modes.

When the Cycle Control (Master) is in automatic mode (Aut) the Auto Cycle Mode L.E.D. located in the lower right hand corner of the display will be constantly illuminated (on).

Before starting an automatic indexing cycle, the Programmable Variables need to be set for both controls (Refer to the section “Programming The Automatic Cycle Parameters/Variables” later in this manual for further details).

Prior to starting an automatic indexing cycle, the motorized cyclic device and the motorized indexing device should be manually positioned to their correct starting locations.

The Index Control (Slave) should have the Forward/Neutral/Reverse switch in the Neutral position, the Run/Stop switch in the Run position and the speed set to that desired during an index.

The Index Control (Slave) sends a “Ready” signal to the Cycle Control (Master) whenever its Run/Stop switch is in the Run position, the relevant limit switch does not impede its Index Direction and no error conditions exist. If the Cycle Control (Master) does not receive the Ready signal, it will not permit the activation of a new automatic indexing cycle, or will instantly perform a controlled shut down of an active automatic indexing cycle.

Automatic Index Cycle Details

This section refers to parameter settings and values. Details of accessing and changing these settings and values can be found later in this manual under the section “Programming The Automatic Cycle Parameters/Variables”.

1. The automatic cycle is initiated by placing the Run/Stop switch of the Cycle Control (Master) in the Run position.
 - a. If the Cycle Control (Master) is receiving the Ready signal from the Index Control (Slave) the cycle proceeds to section 2.
 - b. If the Cycle Control (Master) is not receiving the Ready signal from the Index Control (Slave) the cycle aborts, resets and displays “End”.
2. The Cycle Control (Master) looks at the status of the limit switches on the cyclic device (“KAT”®).
 - a. If a single limit switch is activated, the cycle will proceed to section 4.
 - b. If no limit switches are activated, the cycle will proceed to section 3.
 - c. If no limit switches are recognized, the cycle aborts, resets and “Er.4” is displayed.
3. The Cycle Control (Master) will look at the status of its Forward/Neutral/Reverse direction switch.
 - a. If the switch is in either Forward or Reverse position the cycle proceeds to section 4.
 - b. If the switch is in the Neutral position, the automatic cycle will wait until either a direction is manually chosen by this switch, or the automatic cycle is terminated.
4. The Arc Signal Relay is energized (using CN81 of the “Cycle Control”) and the “Travel Motion Delay” timing cycle (“P. 1”) is initiated. The cycle then proceeds to section 5.
5. Upon completion of the “Travel Motion Delay”, the cyclic device (“KAT”®) starts to travel at the speed set by its speed adjustment knob, in the opposite direction to that of its activated limit switch. If neither limit switch is activated, it initially travels in the direction set by its Forward/Neutral/Reverse switch. The cycle then proceeds to section 6.
6. The cyclic device will stop when it reaches its travel limit switch.
 - a. If the “Arc On/Off During Index” parameter (“P. 2”) is set to On, the cycle proceeds to section 10.
 - b. If the “Arc On/Off During Index” parameter (“P. 2”) is set to Off, the cycle proceeds to section 7.
7. Once the cyclic device (“KAT”®) has stopped, the “Crater Fill Delay” timing cycle (P. 3”) is initiated. The cycle then proceeds to section 8.

8. Upon completion of the “Crater Fill Delay” (maintaining the Arc Signal Relay after the weld motion has ceased, thereby filling the weld crater) the Arc Signal Relay is de-energized and the “Post Weld Delay” timing cycle (“P. 4”) is initiated. The cycle then proceeds to section 9.
9. Upon completion of the “Post Weld Delay” (keeping the gun/torch stationary to allow time for any burn-back or post flow welding functions), the cycle proceeds to section 10.
10. The Cycle Control (Master) sends the “Index Command” to the Index Control (Slave).
11. The Index Control (Slave) will then drive the indexing device (motorized rack arm) at the speed set by its speed adjustment knob, in the preset “Index Direction” (“P.I.1”). The cycle then proceeds to section 12.
12. When the index device reaches the preprogrammed “Index Distance” value (“P.I.2”) as counted by the engineering units, the index motion will cease and the Index Control (Slave) will activate the “Index Complete” signal to the “Cycle Control”. The cycle then proceeds to section 13.
13. When the Cycle Control (Master) receives the “Index Complete” signal from the Index Control (Slave), it will reset its “Index Command” signal, which will then instruct the Index Control (Slave) to reset its “Index Complete” signal.
 - a. When the Cycle Control (Master) receives the “Index Complete” signal, the cycle will proceed to section 16, if the “Arc On/Off During Index” parameter (“P. 2”) is set to On.
 - b. When the Cycle Control (Master) receives the “Index Complete” signal, the cycle will proceed to section 14, if the “Arc On/Off During Index” parameter (“P. 2”) is set to Off.
14. The Arc Signal Relay is re-energized (CN81 of the Cycle Control) and the “Travel Motion Delay” timing cycle (“P. 1”) is re-initiated. The cycle then proceeds to section 15.
15. Upon completion of the “Travel Motion Delay”, the cycle then proceeds to section 16.
16. The cyclic device (“KAT”[®]) starts to travel at the speed set by its speed adjustment knob, in the opposite direction to that of its activated limit switch. The control ignores the present direction setting of the Forward/Neutral/Reverse switch, if any. The cycle then proceeds to section 17.
17. The cycle continues as described between section 6 and 17 until an event described in section 18 occurs.
18. The automatic indexing cycle continues as described until; the Run/Stop switch of the Cycle Control (Master) is placed in the Stop position; the Forward/Neutral/Reverse switch of the Cycle Control (Master) changes state; or the Cycle Control (Master) no longer receives the “Ready” signal from the Index Control (Slave), at which point the cycle proceeds to section 19.
19. The cyclic device (“KAT”[®]) motion will cease immediately and the “Crater Fill Delay” timing cycle (“P. 3”) is initiated. The cycle then proceeds to section 20.
20. Upon completion of the “Crater Fill Delay” (maintaining the Arc Signal Relay after the weld motion has ceased, thereby filling the weld crater) the Arc Signal Relay is de-energized and the “Post Weld Delay” timing cycle (“P. 4”) is initiated. The cycle then proceeds to section 21.
21. Upon completion of the “Post Weld Delay”, the cycle terminates, resets and displays “End”.

Notes:

The indexing device (motorized rack arm) can be manually driven during an automatic cycle by using the Forward/Neutral/Reverse switch of the Index Control (Slave). However, manual operation will be disallowed and the Forward/Neutral/Reverse switch position ignored, during an actual index.

The “Index Command” signal is a high signal generated from CN84 of the Cycle Control (Master) and is registered between pins 1 & 2 of CN12 of the Index Control (Slave).

The “Ready” signal is a high signal generated from CN83 of the Index Control (Slave) and is registered between pins 1 & 2 of CN12 of the Cycle Control (Master).

The “Index Complete” signal is a high signal generated from CN84 of the Index Control (Slave) and is registered between pins 1 & 3 of CN12 of the Cycle Control (Master).

A terminated cycle will reset the “Index Command” and the “Index Complete” signals.

If the Cycle Control (Master) detects an encoder problem, (either the encoder is not connected, or does not provide feedback for one second after the motor output has been energized), the control will display “Er.5” and will not function until the problem is rectified. If the control is powered-up with a faulty or missing encoder, it will flash “Er.5” for 5 seconds, switch itself to “open loop mode” and allow full operation in both manual and automatic modes (in open loop mode, there is no travel speed regulation and travel speed is displayed as a percentage rather than actual speed).

If the Index Control (Slave) detects an encoder problem, (either the encoder is not connected, or does not provide feedback for one second after the motor output has been energized), the control will display “Er.5” and will not function until the problem is rectified. If the control is powered-up with a faulty or missing encoder, it will flash “Er.5” for 5 seconds, switch itself to “open loop mode” and allow manual operation (in open loop mode, there is no travel speed regulation and travel speed is displayed as a percentage rather than actual speed), however, if an automatic cycle is initiated, when the time comes to perform an index, the control will display “Er.5” , the auto cycle will abort and Index Control (Slave) will not function until the problem is rectified.

When limit switches stop or inhibit commanded travel motion, the relevant directional LED will flash on and off until the commanded motion is reset.

Programming The Automatic Cycle Parameters/Variables

The Program Variable Selector Switch is used to select the different programmable parameters that allow the operator to change their values and settings and so define how the automatic cycle will function. The Program Variable Selector Switch is located between and below the Run/Stop switch and the Forward/Neutral/Reverse switch of the GSP control. The GSP controls that are typically supplied with the “KAT”® carriage indexing systems have Program Variable Selector Switches, which extend through

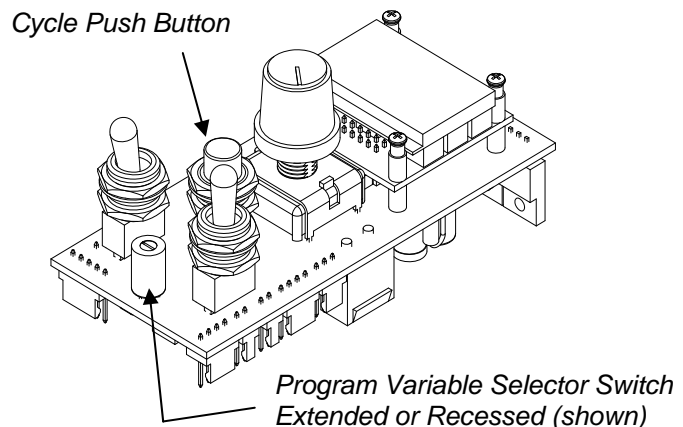

the faceplate of the controls. Other styles of control are available where the removal of a hole-plug for access and a small flat-bladed screwdriver for adjustment are required (as shown in adjacent sketch).

Zero (0) (top dead center) is the normal operating location for the rotary selector switch. When in any position other than zero (0) the control is in programming mode, the round, Auto Cycle Mode L.E.D. in the bottom right hand corner of the display will flash and the motor control will not allow normal operation.

To make changes to the program variables, turn the power on and place the Run/Stop switch in the Stop position, then rotate the Program Variable Selector switch to the variable (parameter) to be altered (the Auto Cycle Mode L.E.D. will flash on and off). The number of the variable parameter will be displayed when the Forward/Neutral/Reverse switch is in the Neutral position. I.e. Cycle Control (Master) - "P. 1", "P. 2", "P. 3", etc. & Index Control (Slave) - "P.I.1", "P.I.2", "P.I.3", etc. To see the current value/setting of the variable, place the Forward/Neutral/Reverse switch in either the Forward or Reverse position. To increment the value/setting, place the Forward/Neutral/Reverse switch in the Forward position and press the Cycle Push Button. To decrement the value/setting, place the Forward/Neutral/Reverse switch in the Reverse position and press the Cycle Push Button. Pressing the Cycle Push Button briefly will increment/decrement the value/setting by one, whereas keeping the Cycle Push Button depressed will scroll through the values/settings until released. The speed display and/or the individual L.E.D.'s will indicate the chosen value/setting. When all of the program variables are set, place the Program Variable Selector switch back to the zero position (the Auto Cycle Mode L.E.D. will stop flashing).

The values/settings of the variables are stored on the product/application specific micro-processor chip. If the chip is replaced, the values/settings of the variables will need to be re-entered.

The following label is applied to each "KAT"® carriage indexing system to graphically identify the individual programmable parameters/variables:

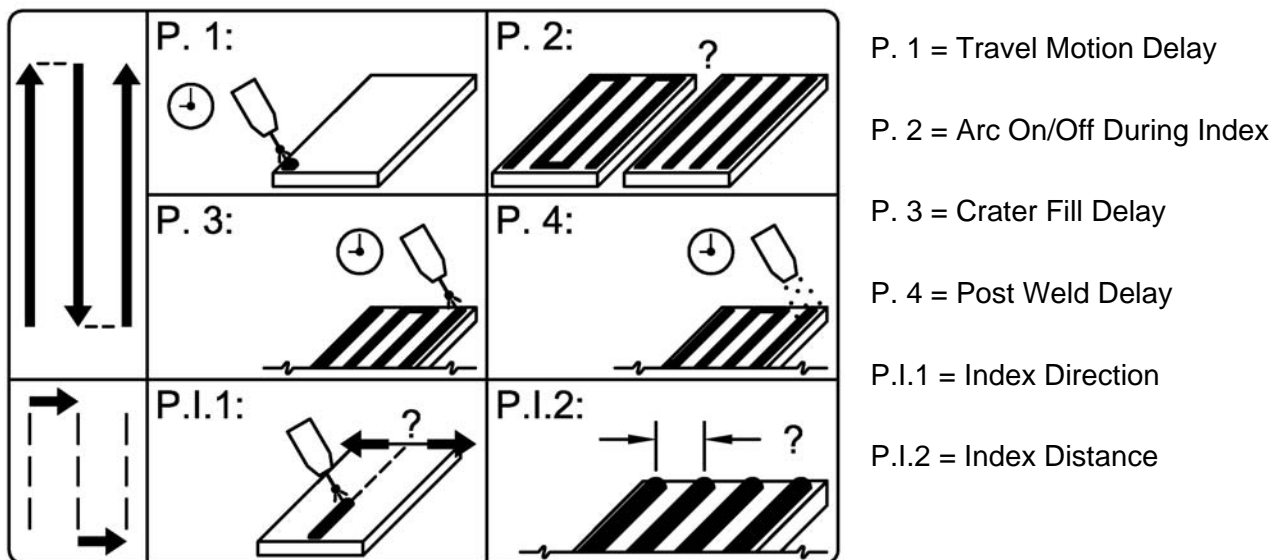

Description of Programmable Parameters/Variables

Cycle Control (Master)

The following describes the Program Variable Selector Switch settings for the GSP motor control using Gullco's GSP-2004-5 micro-processor chip (Cycle Control), as rotated clockwise from zero (0) top dead center.

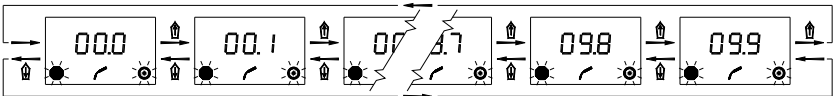
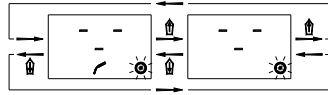
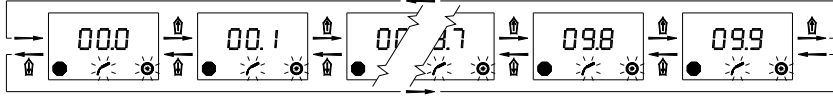
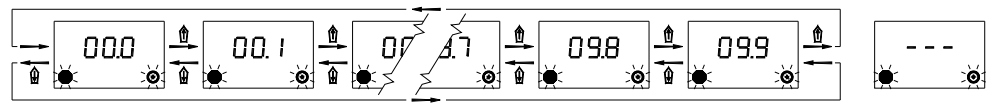
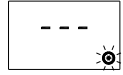
Position	Details:
0	Normal Operating Position - The control needs to be in this position to allow normal operation of the unit (top-dead-center).
P. 1	<p>Travel Motion Delay - Sets a delay after the activation of the Arc Signal Relay, prior to starting the cyclic travel, to allow for such things as shielding gas preflow and to allow the arc to establish before starting the overlay/surfacing motion. The variable value range is from 00.0 to 09.9 seconds, in increments of 00.1 seconds.</p> 
P. 2	<p>Arc On/Off During Index – When this parameter is set to “On” the Arc Relay Signal remains energized during the gun/torch indexing motion. When this parameter is set to “Off” the Cycle Control (Master) will perform a controlled shut down of the Arc Signal Relay prior to each index and perform a controlled start-up of the Arc Signal Relay following each index. The variable options are either “On” (illuminated Arc Signal Relay LED) or “Off” (extinguished Arc Signal Relay LED).</p> 
P. 3	<p>Crater Fill Delay - Sets a delay after the cessation of overlay/surfacing travel (including the end of each cyclic pass, if the “Arc On/Off During Index” (P. 2) is set to “Off”) prior to de-energizing the Arc Signal Relay, allowing the overlay/surfacing trigger signal to remain active for a period of time after the motion has stopped. The variable value range is from 00.0 to 09.9 seconds, in increments of 00.1 seconds.</p> 
P. 4	<p>Post Weld Delay - Sets a delay after each Crater Fill Delay (above) prior to allowing the index motion (only applicable if the “Arc On/Off During Index” (P. 2) is set to “Off”). This is to allow the overlay/surfacing gun/torch to remain stationary over the end of the overlay/surfacing for such things as burnback or postflow to occur. The variable value range is from 00.0 to 09.9 seconds, in increments of 00.1 seconds.</p> 
P. 5 to P. 9	<p>Reserved for future use.</p> 

Index Control (Slave)

The following describes the Program Variable Selector Switch settings for the GSP motor control using Gullco's GSP-2004-7 micro-processor chip (Index Control), as rotated clockwise from zero (0) top dead center.

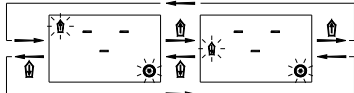
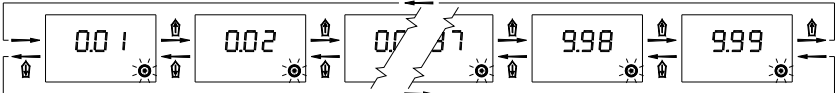
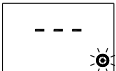
Position	Details:
0	Normal Operating Position - The control needs to be in this position to allow normal operation of the unit (top-dead-center).
P.I.1	Index Direction – Programs the direction that the indexing device is to move the gun/torch for each index. The variable options are either “Forward” (illuminated Forward Motion Commanded LED) or “Reverse” (extinguished Forward Motion Commanded LED). 
P.I.2	Index Distance - Sets the incremental distance that the indexing device will travel for each gun/torch index. If the motor control speed display is calibrated in inches per minute, these parameter values will represent index distance in inches. If the speed display is calibrated in centimetres per minute, these parameter values will represent index distance in centimetres. The variable value range is from 0.01 to 9.99, in increments of 0.01 
P.I.3 to P.I.9	Reserved for future use. 

Factory Settings:

The following table shows the settings/values of the Programmable Parameter/Variables as supplied from the factory:

Switch Position	Parameter	Value	
Cycle Control (Master)	P. 1	Travel Motion Delay	00.3 (seconds)
	P. 2	Arc On/Off During Index	On
	P. 3	Crater Fill Delay	00.3 (seconds)
	P. 4	Post Weld Delay	01.0 (seconds)
Index Control (Slave)	P.I.1	Index Direction	Forward
	P.I.2	Index Distance	0.18" or 0.46cm

ACCESSORIES

<p>GK-191-P-071 Arc Signal Relay Kit</p>	<p>Additional Arc Signal Relay kits can be installed on the “KAT”[®] carriage indexing system to provide multiple isolated relay signals (generated by the GSP control during automated overlay/surfacing cycles), to the trigger input of multiple overlay/surfacing units.</p>
<p>GK-190-067 Lower Housing Dust Cover (Rigid “KAT”[®])</p>	<p>A cover which is installed to a rigid “KAT”[®] carriage lower housing, reducing the drive opening to minimize dust & smoke pollutions to the interior of the “KAT”[®] carriage.</p>
<p>GK-190-068 Lower Housing Dust Cover (Flex “KAT”[®])</p>	<p>A cover which is installed to a Flex “KAT”[®] carriage lower housing, reducing the drive opening to minimize dust & smoke pollutions to the interior of the “KAT”[®] carriage.</p>
<p>GK-166-169 Low Speed Gear Assembly (Rigid “KAT”[®])</p>	<p>An external gear assembly is available which can easily be fitted to any of the rigid track “KAT”[®] carriages to decrease the available speed range.</p>
<p>GK-166-153 High Speed Gear Assembly (Rigid “KAT”[®])</p>	<p>An external gear assembly is available which can easily be fitted to any of the rigid track “KAT”[®] carriages to increase the available speed range.</p>

Other Accessories:

The Gullco “KAT”[®] carriage is drilled to facilitate the mounting of rack boxes and rack box riser brackets, cable support brackets, as well as links for towing idler carriages. Many other accessories such as remote controls, oscillation, seam tracking and auto stitch welding (amongst others) are also available for fitting to the “KAT”[®] all position, variable speed travel carriage.

**Visit Gullco’s web site, “www.gullco.com”
to see, or request, more product and
application information.**

REVISIONS LIST

October, 2004

Overall First Release.

August, 2006

Overall Updated all circuit board connector identifications to new standards.

Page 12 Corrected details of the “Ready” and “Index Complete” signals.

June, 2011

Front page Updated contact details

Back page Updated back page.

March, 2012

Front page Updated view of carriage to include the redesigned Four motion gun holder assembly

ADDITIONAL NOTES

Specifications and products are subject to change without notice.

KAT, Moggy, Sam, KATBAK & KBM are registered trademarks of Gullco International Enterprises Ltd.

Only use genuine/authorized replacement parts.



GULLCO



LINEAR or RADIAL
HIGH DEPOSIT RATE
QUICK SETUP TIME

KAT® OSCILLATOR

- Motorized weld center line adjustment
- Motorized stroke width
- Oscillation speed control
- Store up to 10 welding programs



PORTABLE PLATE EDGE
BEVELLING MACHINE
QUICK SETUP TIME

KBM®

- Produce clean bevels with no thermal distortion
- Bevels angles 22° to 55° (other angles available)
- Hydraulic and Adjustable undercarriages available
- Bevels Mild Steel, Stainless Steel, and Aluminium
- Reduce cost and save time by minimising defects and poor fit up

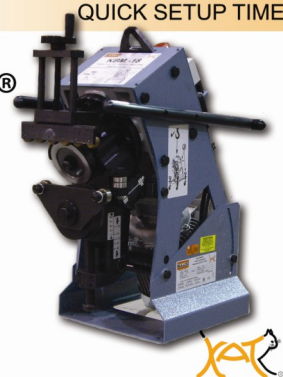

ONE SIDED WELDING
X-RAY QUALITY BEADS
HIGH DEPOSIT RATE

KATBAK® CERAMIC WELD BACKING

- Eliminate Defects And Rework
- Eliminate Costly Unnecessary Gouging And Grinding
- Sizes 1/4" (6.3 mm) to 2" (51 mm)
- Special Sizes And Configurations Available

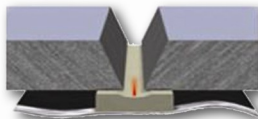

PORTABLE AND COMPACT
INCREASE EFFICIENCY
MORE ARC ON TIME

MOGGY® FILLET WELD CARRIAGE

- Single or Dual Torch Models
- Magnet or Non Magnetic Base
- Continuous or Stitch Welding Models
- Fillet, Lap, Butt and Dual Torch Welding

