

X3G FastGouge 800

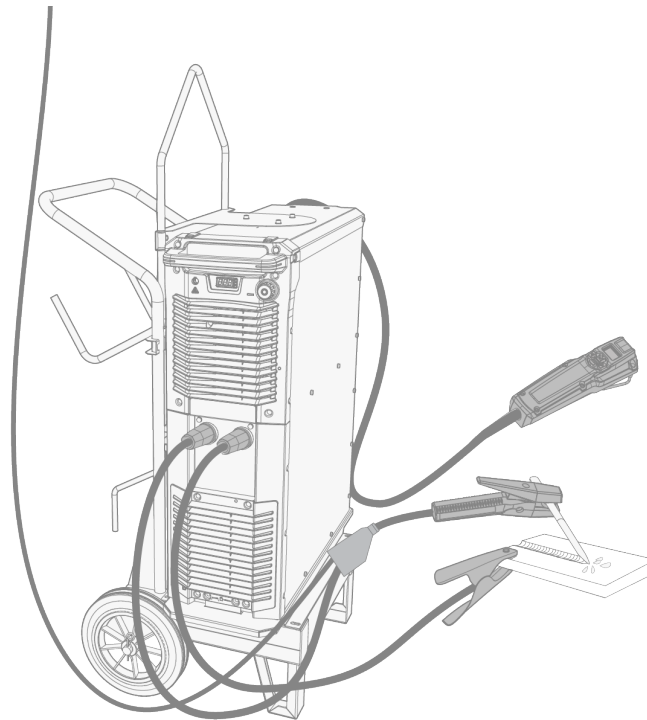

CONTENTS

1. General	3
2. Safety	5
3. About equipment	6
3.1 About carbon arc gouging	8
4. Installation	9
4.1 Installing power source mains plug	10
4.2 Installing gouging torch and earth return cable	11
4.3 Installing HR53 remote control (optional)	13
4.4 Installing on carts (optional)	14
5. Operation	18
5.1 Starting	19
5.2 Using X3G FastGouge 800 control panel	20
5.3 Using HR53 remote control (optional)	22
5.4 Troubleshooting and error codes	23
6. Maintenance	25
6.1 Daily, periodic and annual maintenance	26
6.2 Replacing and cleaning power source air filter	27
6.3 Disposal	28
7. Technical data	29

1. GENERAL

These instructions describe the use of Kemppi's X3G FastGouge 800 heavy-duty carbon arc gouging power source. It is designed for professional use.

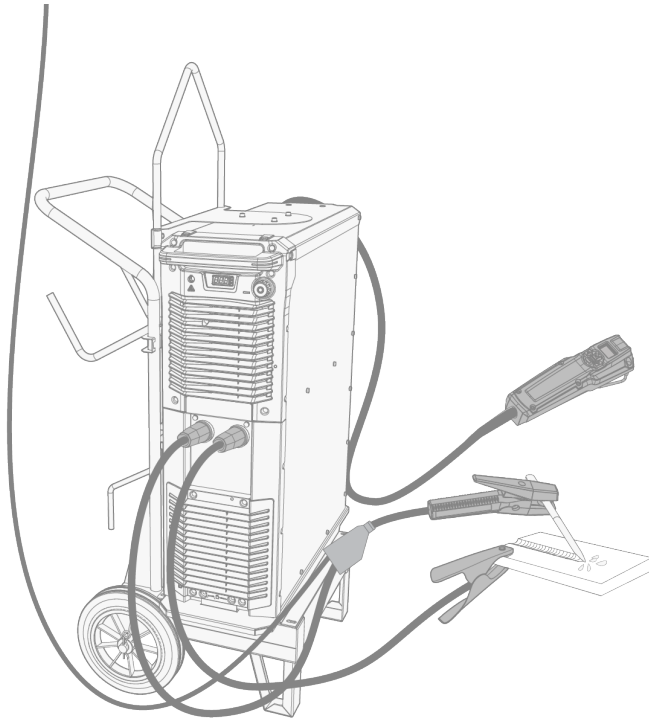

* The accessories such as the transport unit and the remote control shown in the illustration are optional extras. The gouging torch (carbon electrode holder) and earth return cable are also to be purchased separately, but are required for operation.

The equipment used in carbon arc gouging comprises the gouging power source, a gouging torch (carbon electrode holder) and its cables, and the gouging carbon electrode, which can be round or flat. Note that also a sufficient compressed air supply must be available.

Basic MMA welding is also possible with X3G FastGouge 800. This requires a separate MMA electrode holder.

Important notes

Read the instructions through carefully.

Items in the manual that require particular attention in order to minimize damage and harm are indicated with the below symbols. Read these sections carefully and follow their instructions.

 *Note: Gives the user a useful piece of information.*

 *Caution: Describes a situation that may result in damage to the equipment or system.*

 *Warning: Describes a potentially dangerous situation. If not avoided, it will result in personal damage or fatal injury.*

DISCLAIMER

While every effort has been made to ensure that the information contained in this guide is accurate and complete, no liability can be accepted for any errors or omissions. Kempfi reserves the right to change the specification of the product described at any time without prior notice. Do not copy, record, reproduce or transmit the contents of this guide without prior permission from Kempfi.

2. SAFETY

Welding and carbon arc gouging are always classified as hot work, and the related equipment typically contains high-voltage circuits. If you are not familiar with welding and carbon arc gouging principles, it is recommended that you acquire training or professional guidance before commencing operation. The equipment mentioned in this manual is intended for professional use in an industrial environment.



For your own safety, and that of your working environment, pay particular attention to the safety instructions delivered with the equipment.

You can also access and download the safety instructions by using these links:

- [Safety](#)

(<https://kemp.cc/safety/general>)

- [Welding torches](#)

(<https://kemp.cc/safety/torches>)

3. ABOUT EQUIPMENT

The basic equipment setup comprises of the X3G FastGouge 800 carbon arc gouging power source.

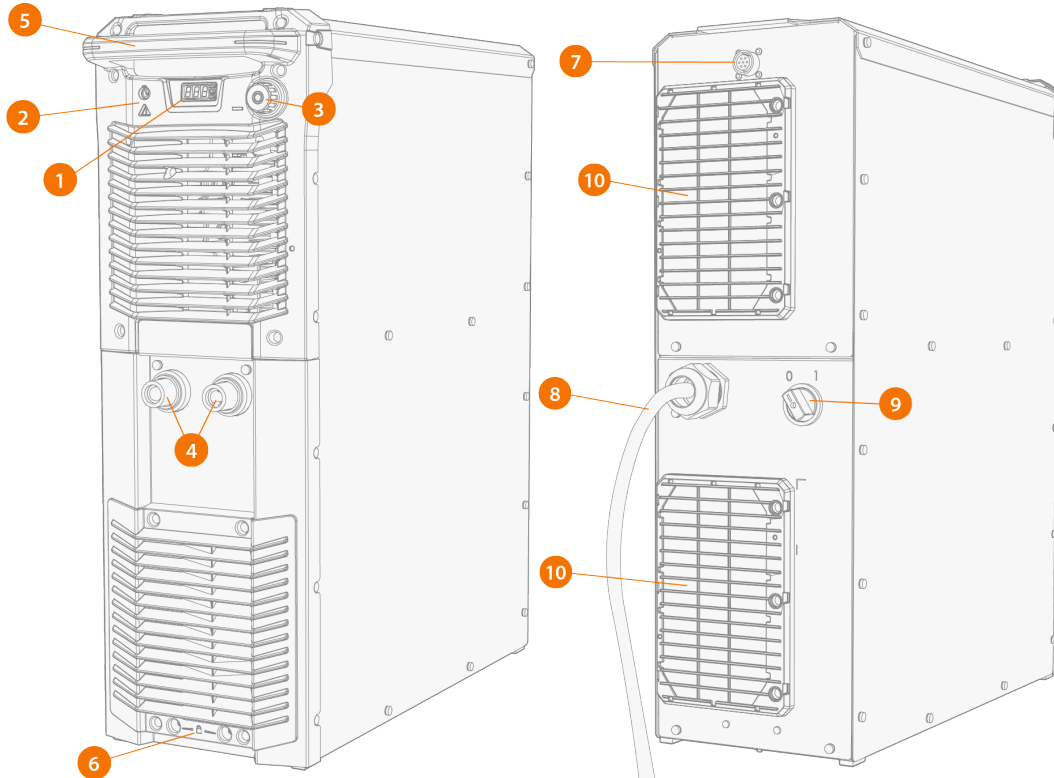

1. 7-segment display
2. Status indicators
3. Control knob

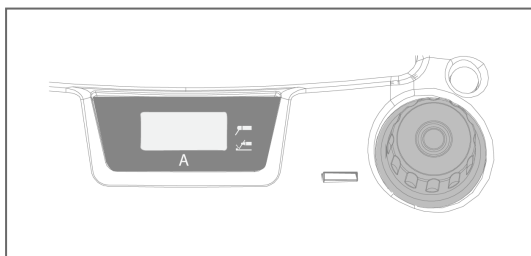

4. DIX +/- connectors
5. Handle
6. Connection interface to optional cart
7. 7-pin control cable connector (for remote control)
8. Mains power cable
9. ON/OFF switch
10. Air intake and replaceable air filter

Accessories and optional extras

- Gouging torch (carbon electrode holder)
>> 6285401 GT4000 Gouging torch BL 2.1 m
- Earth return cable
>> 61841201 Earth return cable 5 m, 120 mm²

- >> 61841202 Earth return cable 10 m, 120 mm²
- X5 4-wheel cart
 - >> X5701020000 X5 Gas cylinder cart
- X3G 2-wheel trolley
 - >> X3GT2 X3G 2-wheel trolley
- HR53 hand remote control unit
- Air filters
 - >> SP027772 X3 Power source filter.

EQUIPMENT IDENTIFICATION

Quick Response (QR) code

Device-related information or a web link to such information may be found in the form of a QR code on the device. The code can be read, for example, with a mobile device camera and a QR code application.

3.1 About carbon arc gouging

Carbon arc gouging is a method where metal is removed by melting it with a welding arc and blowing the melted metal away with compressed air. Carbon arc gouging can be used with the majority of metals, such as steel, stainless steel, cast iron, nickel, copper, magnesium and aluminum.

There are two main types of gouging carbons, round and flat. A round gouging carbon can be used in:

- Opening a root weld
- Opening faulty welds and cracks
- Manufacturing welding grooves
- Cutting metal
- Making holes.

A flat carbon can be used in:

- Arc grading of surface errors in roller slabs
- Cleaning steel casts
- Opening faulty casts
- Arc grading of weld caps.

A round gouging carbon electrode is best suited for general carbon arc gouging applications.







For general guidance only. Current recommendations for different-sized round gouging carbon electrodes:

Round carbon size	4 mm (5/32")	5 mm (3/16")	6.35 mm (1/4")	8 mm (5/16")	9.5 mm (3/8")	13 mm (1/2")
Current (A)	80...150	110...200	170...330	230...450	300...550	460...800



Do not exceed the maximum current specified for a gouging carbon as it will accelerate carbon wear. The gouging current is too high if the copper coating melts faster than the gouging carbon.



4. INSTALLATION

-  *Do not connect the equipment to the mains before the installation is complete.*
-  *Do not modify the equipment in any way, except for the changes and adjustments covered in the manufacturer's instructions.*
-  *Do not attempt to move or hang the equipment mechanically (e.g. with a hoist) from the handle on the power source unit. The handles are for manual moving only.*
-  *Check that there is enough space for cooling air circulation in the machine vicinity. There should be a minimum of 15 centimeters of free space around the equipment for unobstructed air circulation.*
-  *Protect the machine from rain and direct sunshine.*
-  *Place the machine on a horizontal, stable and clean ground.*

Before installation

- Make sure to acknowledge and follow the local and national requirements regarding installation and use of high voltage units.
- Check the contents of the packages and make sure the parts are not damaged.
- Before you install the power source on site, see the requirements for the mains cable type and fuse rating.

Distribution network

-  *This Class A equipment is not intended for use in residential locations where the electrical power is provided by the public low-voltage supply system. There can be potential difficulties in ensuring electromagnetic compatibility in those locations, due to conducted as well as radiated radio-frequency disturbances.*
-  *Provided that the short circuit power of public low voltage system at the point of common coupling is higher than 6.0 MVA, the equipment is compliant with IEC 61000-3-11:2017 and IEC 61000-3-12:2011 and can be connected to public low voltage systems. It is the responsibility of the installer or user of the equipment to ensure, by consultation with the distribution network operator if necessary, that the system impedance complies with the impedance restrictions.*

4.1 Installing power source mains plug

 Only an authorized electrician is allowed to install the mains cable and plug.

 Only connect the welding machine to an earthed electric network.

 Do not connect the machine to the mains before the installation is complete.

The X3G FastGouge 800 gouging power source is connected to a 380...415 V 3-phase network.

Before taking into use, check the connection cable and install a mains plug. If the cable does not comply with the local electrical regulations, replace it with a compliant cable.

Install the 3-phase plug according to the X3G FastGouge 800 power source and the site requirements. Refer also to "Technical data" on page 29 for power source specific technical information.

The mains cable includes the following wires:

1. Brown: L1
2. Black: L2
3. Grey: L3
4. Yellow-green: Protective earth

Table. Cable type and fuse rating requirements:

Unit amperage	Cable size	Fuse rating
800 A	16 mm ²	63 A

4.2 Installing gouging torch and earth return cable

Connecting the gouging torch cable

The gouging torch cable is connected to the power source's DIX connector. The cable is connected either to the positive (+) or negative (-) connector on the power source, depending on the metal to be worked on.

- For steel: Positive (+)
- For cast iron: Negative (-)
- For non-iron metal: Negative (-)

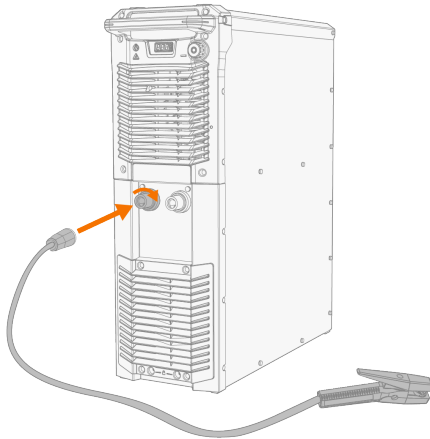

The gouging cable is rubber-insulated copper cable. The table below shows the typical load capacities of the cables when the ambient temperature is 25 °C and the lead temperature is 85 °C.

Cable	Duty cycle				Voltage loss / 10 m
	100%	60%	35%	20%	
50 mm ²	285 A	316 A	371 A	458 A	0.35 V / 100 A
70 mm ²	355 A	403 A	482 A	602 A	0.25 V / 100 A
95 mm ²	430 A	498 A	606 A	765 A	0.21 V / 100 A
120 mm ²	500 A	587 A	721 A	917 A	0.18 V / 100 A

 Do not overload the gouging cables, as an overload may cause voltage loss and overheating.

 For MMA welding, instead of the gouging torch (carbon electrode holder) and compressed air hose, connect a MMA electrode holder to the power source.

For more information on the GT4000 gouging torch, refer to the instructions delivered with the gouging torch, or go to userdoc.kemppi.com.

Connecting the compressed air hose

Connect the compressed air hose to the gouging torch:

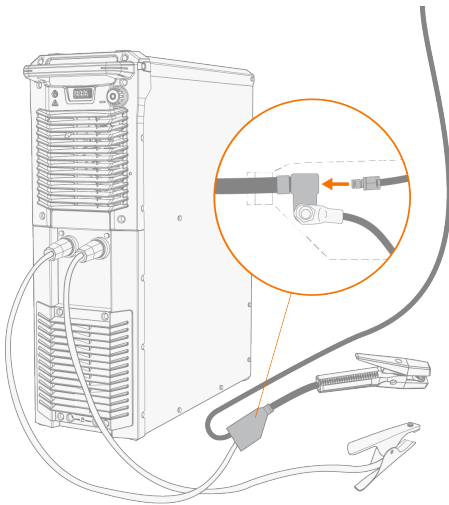

Connecting the earth return cable

The earth return cable is connected to the power source's DIX connector. The cable is connected either to the positive (+) or negative (-) connector on the power source, depending on the metal to be worked on. The cable recommendations are listed in the previous table.

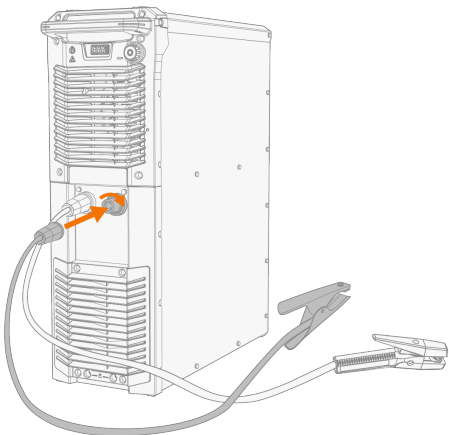

Connect the earth return cable clamp directly to the work piece so that the contact surface is maximized. The point of connection must be unpainted and free of corrosion.



The maximum cable loop length is 50 meters. (The cable loop length is the earth return cable length and the gouging cable length combined.)

4.3 Installing HR53 remote control (optional)

Remote controls are optional accessories. To enable remote control operation, connect the remote control device to the X3G FastGouge 800 equipment.

Connect the remote control cable to the control cable connector on the rear of the power source:

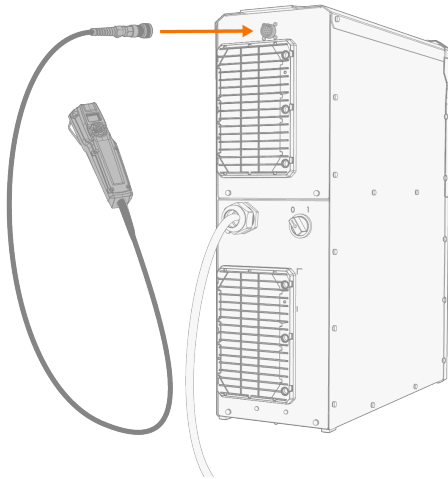

For using the HR53 remote control, refer to "Using HR53 remote control (optional)" on page 22.

4.4 Installing on carts (optional)

Transport carts are optional accessories. Install and prepare the carts according to the installation instructions delivered with the carts. Follow their instructions in conjunction with this installation chapter.

 *The weight of the X3G FastGouge 800 carbon arc gouging power source is more than 70 kg. Do not attempt to lift and install the equipment alone.*

Tools needed:

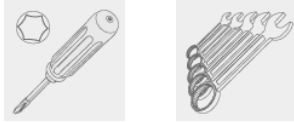

Installing on X3G 2-wheel trolley cart

1. Place the cart's bottom plate on the ground and lift the power source on the plate so that the fixing brackets align with the fixing holes.

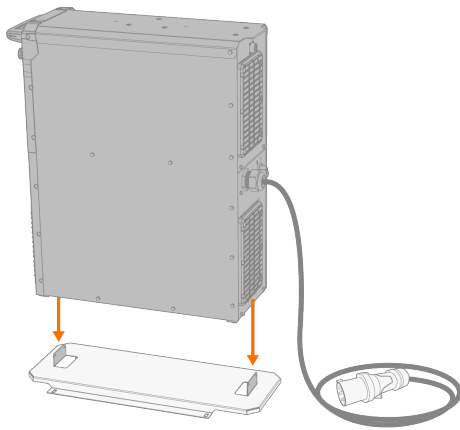

2. Secure the power source to the bottom plate with the screws provided (2 x M5x12 screws in the front, 2 x M5x12 screws in the rear).

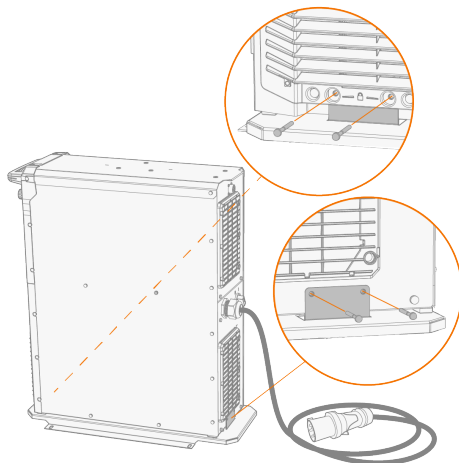

3. Lift the power source and cart bottom plate assembly on top of the cart and secure the assembly to the cart through each corner of the bottom plate. Use the bolts (4 x M8x12), nuts (4 x M8) and washers (8 x M8) provided with the cart.

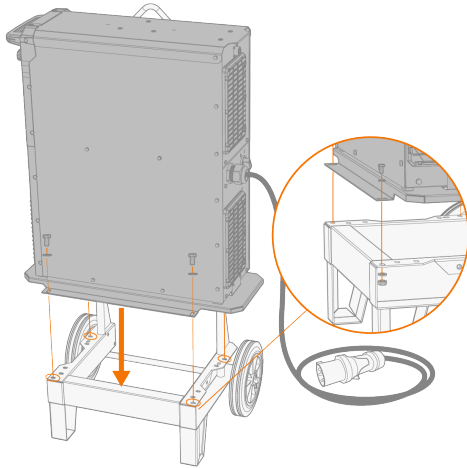

4. Place the top support plate on the power source and align the fixing hook plates through the support plate holes so that they can go behind and around the cart frame bars on both sides. Secure the support plate in place from the rear with the bolts provided (2 x M6x16 bolts and 2 x M6 washers) through the fixing plates.

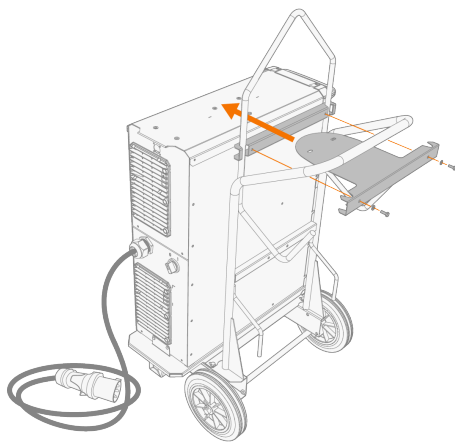

5. Secure the top support plate to the power source with the screws provided (3 x M6x16 and 3 x M6 washers).

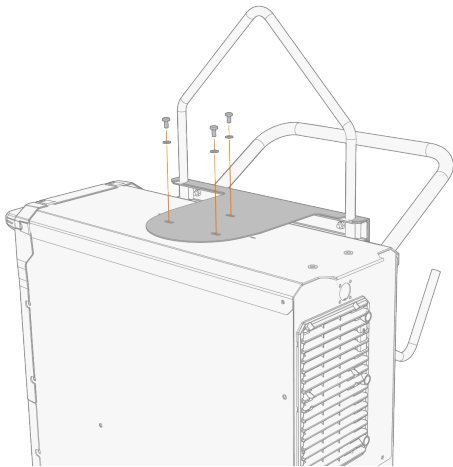

Installing on X5 4-wheel cart (X5 Gas cylinder cart)

1. Lift the power source on the cart so that the fixing brackets align with the fixing holes. Secure the power source to the bottom plate with the screws provided (2 x M5x12 screws in the front, 2 x M5x12 screws in the rear).

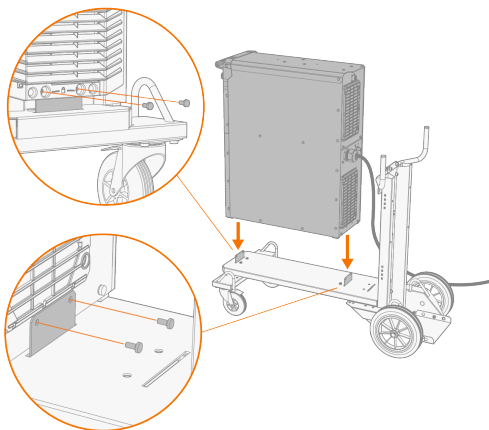



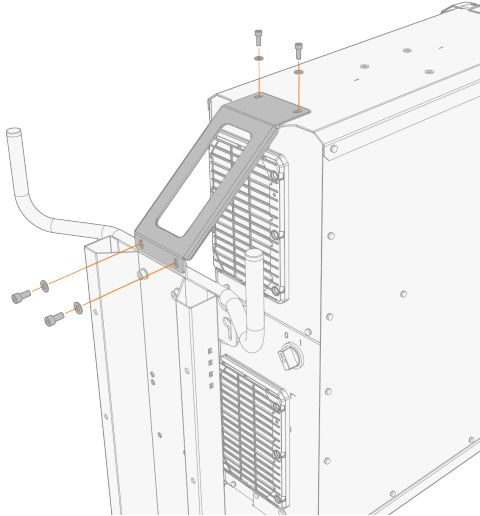

2. Secure the power source to the cart with the top support plate. Fix the plate to the power source top and the cart frame rear with the screws provided (2 x M6x12 screws and washers on the top, 2 x M8x16 screws and washers in the rear).

 *The top support plate is specific for X3G FastGouge 800, and it is delivered with the power source.*



5. OPERATION

Before using the equipment, ensure that all the necessary installation actions have been completed according to your equipment setup and instructions.

-  *Welding and carbon arc gouging is forbidden in places where there is an immediate fire or explosion hazard!*
-  *Welding and gouging fumes may cause injury. Take care to ensure sufficient ventilation during welding and carbon arc gouging, and wear respiratory protection!*
-  *Check that there is enough space for cooling air circulation in the machine vicinity. There should be a minimum of 15 centimeters of free space around the equipment for unobstructed air circulation.*
-  *Always check before use that the equipment cables and hoses are in serviceable condition. Ensure that the connectors are correctly fastened. Loose connectors can impair welding performance and damage connectors.*
-  *If the equipment is left unused for a longer period, disconnect the mains plug from the mains.*

5.1 Starting

Before starting

- Ensure the installation has been completed according to your equipment setup and work requirements.
>> Refer to the installation chapters in this operating manual.
- Select a gouging carbon suitable for the work piece and the carbon holder on the gouging torch.
>> Attach the gouging carbon to the holder in such a way that the free length of the carbon is 100...150 mm.
- Connect the gouging cable to the positive or negative connector in the power source depending on the type of metal to be worked. For more information, see "Installing gouging torch and earth return cable" on page 11.
- Connect the compressed air hose and open the compressed air valve.
>> The pressure of the compressed air required in carbon-arc gouging is 500...700 kPa (5...7 bar).
- Connect the earth return cable from the power source to the work piece. Ensure that the surface contact to the work piece is clean of metal oxide and paint and that the clamp is firmly secured.

 *Keep the work piece connected to earth to reduce the risk of injury to users or damage to electrical equipment.*

- Adjust the gouging current to a suitable level. By default, the machine uses the adjustment of the last time the machine was used. For more information on the gouging current, refer to "About carbon arc gouging" on page 8.

 *For MMA welding, instead of the carbon electrode holder and compressed air hose, connect a MMA electrode holder to the power source.*

Turning equipment on

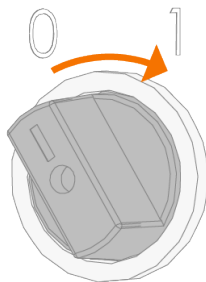

To turn on the equipment, turn the power source main switch to ON (I).

 *Turn the main switch to start and shut down the equipment. Do not use the mains plug as a switch.*

 *If the equipment is left unused for a longer period, detach the mains plug to disconnect the equipment from the mains.*

Make the required parameter adjustments using the power source's control panel. For using the control panel and making the selections and adjustments, refer to "Using X3G FastGouge 800 control panel" on the next page.

Starting carbon arc gouging

The arc is ignited by scratching the work piece with the gouging carbon. The gouging carbon is moved in such a position that the compressed air flow hits the molten material between the gouging carbon and the groove created. A suitable angle for gouging carbon electrode is 20°...45°. If the angle is greater, compressed air cannot blow the molten metal away.

 *Especially when operating with high voltages, the cables can heat up. Always ensure that you're using cables rated for the job. Refer also to "Installing gouging torch and earth return cable" on page 11.*

5.2 Using X3G FastGouge 800 control panel

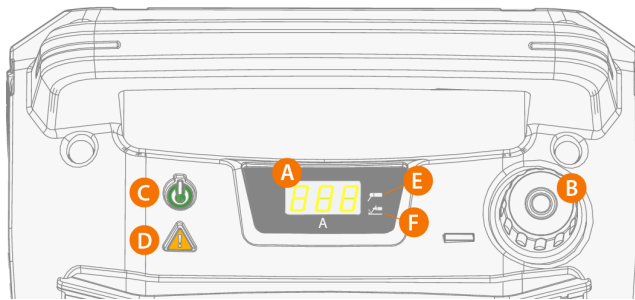

Status indicators

The control panel has four status indication lights:

- Power ON (C)
>> The LED is lit (green) when the power source is on.
- Overheating (D)
>> The LED is lit (amber) when the power source's overheat protection has triggered and operation is prevented.
- MMA welding (E)
>> The LED is lit when the MMA welding mode is selected.
- Carbon arc gouging (F)
>> The LED is lit when the carbon arc gouging mode is selected.

Gouging and MMA current adjustment

The control panel display (A) shows the value of output current in amperes. The value is set by turning the control knob (B).

- In carbon arc gouging, the adjustment is made in 10 A steps.
- In MMA welding, the adjustment is made in 1 A steps.
- Turning the control knob faster allows bigger changes to the value.

During carbon arc gouging or MMA welding, the control panel display shows the actual current value.

Mode selection

The process mode, carbon arc gouging or MMA welding, is selected by long-pressing the control knob (approx. 2 seconds). Every long press of the control knob changes the mode between carbon arc gouging and MMA. Carbon arc gouging is the default mode.

After restart, the unit will use the process mode that was selected when the unit was turned off.

 The X3G FastGouge 800 controls includes several long press functions (see the factory reset feature).

MMA dynamics adjustment

When the MMA welding process mode is selected, the adjusted parameter is changed from welding current to MMA dynamics by pressing the control knob.

>> When entering the adjustment mode, **dyn** text will be shown briefly in the display.

The dynamics adjustment range is +10 ... -10.

When in dynamics adjustment mode, a short press of the control knob changes back to the welding current adjustment.

Factory reset

Factory settings can be reset by long-pressing the control knob for 6 seconds. The texts **FAC** and **rES** will be shown briefly in the display and the reset progress is indicated with dashes (– – –).

Error situation

If the device detects an error situation, it is indicated with **Err** text followed by an error code number on the display. Refer to "Troubleshooting and error codes" on page 23 for error code descriptions.

5.3 Using HR53 remote control (optional)

i The HR53 remote control must have software version **1.03.11.0 or newer** installed for X3G FastGouge 800 use. The remote control's version number can be checked by keeping the left and right arrow buttons pressed simultaneously when starting up the power source.

When connected, the HR53 remote control is automatically in use. With the HR53 remote control, you can adjust current (A) and change between carbon arc gouging and MMA welding modes.

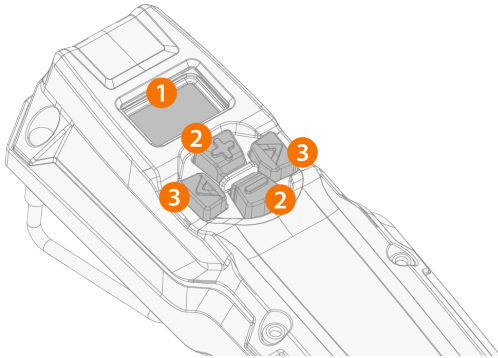

1. LCD display
 - >> Displays the adjusted parameter and notifies if there is an error ("Err") in the welding system.
2. Plus/minus (+/-) buttons
 - >> Changes the parameter value.
3. Left/right arrow buttons
 - >> Changes between parameter adjustment and process mode selection.

Remote control display items

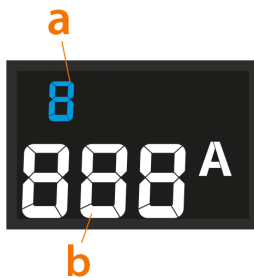

- a. Process mode (indicated with a single letter: G = Gouging, S = MMA)
- b. Adjusted parameter value and adjusted parameter unit (or error indicator "Err").

Remote control views and operation

Change between the views by pressing the left/right arrow buttons.

- **Process selection view:** This allows selecting between carbon arc gouging and MMA welding.
- **Welding power view:** Depending on the operation mode used, gouging current or welding current is adjusted by pressing the +/- buttons. Long press of a +/- button scrolls the parameter values faster.

5.4 Troubleshooting and error codes



The problems and the possible causes listed are not definitive, but suggest some typical situations that may turn up during normal use of the welding system. For further information and assistance, contact your nearest Kemppi service workshop.

General troubleshooting

The welding system does not power up

- Check that the mains cable is plugged in properly.
- Check that the mains switch of the power source is at the ON position.
- Check that the mains power distribution is on.
- Check the mains fuse and/or the circuit breaker.

The welding system stops working

- The torch may have overheated. Wait for it to cool down.
- Check that none of the cables is loose.
- The power source may have overheated. Wait for it to cool down and see that the cooling fans work properly and the air flow is unobstructed.

Carbon arc gouging quality

Large free carbon deposit at the beginning of the groove or at various spots

- Ensure that the air flow is turned on before striking the arc, so that the air flows between the electrode and the work piece.
- Ensure that the gouging carbon is positioned properly in the electrode holder.
- Check that the angle between the electrode and the work piece doesn't get too small.

An unsteady arc (slowing down the travel speed)

- Ensure that the gouging current is enough for the electrode diameter used, or use an electrode smaller in diameter.

Erratic groove and operation, and electrode heating up too fast

- Check the polarity of the connections. For most metals, it is recommended to use the DC electrodes connected to the positive side (in carbon arc gouging). Only a few copper alloys may create an exception.

Irregular groove surface

- Focus on the travel speed when working. Too slow and/or unsteady travel speed in manual gouging can result in irregular groove surface.
- Check that the ground connection and cable are in working order.

Error codes

If the machine encounters an error, it is indicated on the display with "Err" text and an error code number.

Err 1: Power source not calibrated

- Power source calibration has been lost. Restart the power source. If problem persists, contact Kemppi service.

Err 3: Too high mains voltage

- Voltage in mains network is too high. Restart the power source. If problem persists, contact Kemppi service.

Err 4: Power source is overheated

- Too long welding session with high power. Do not shut down, let the fans cool the machine. If fans are not running, contact Kemppi service

Err 5: Internal 24V voltage is too low

- Power source contains an inoperative 24V power supply unit. Restart the power source. If problem persists, contact Kemppi service.

Err 10: Missing power supply unit

- Internal communication error. Restart the power source. If problem persists, contact Kemppi service.

Err 14: IGBT overheated

- Too long welding session with high power or high ambient temperature. Do not shut down, let the fans cool the machine. If fans are not running, contact Kemppi service.

Err 17: Phase is missing from mains supply

- One or more phases are missing from the mains supply. Check the mains cable and its connectors. Check the voltage of mains supply.

Err 244: Internal memory failure

- Initialization failed. Restart welding system. If problem persists, contact Kemppi service.

Err 250: Internal memory failure

- Memory communication failed. Restart welding system. If problem persists, contact Kemppi service.

Other error codes: The machine can show codes not listed here. In such case, contact an authorized Kemppi service.





6. MAINTENANCE

6.1 Daily, periodic and annual maintenance

When considering and planning routine maintenance, consider the operating frequency of the equipment and the working environment.

Correct operation of the equipment, regular maintenance, and the use of original Kemppi spare parts and consumables help you avoid unnecessary downtime and equipment failure, while also maximizing the equipment's service life.

For repairs, find your closest Kemppi service workshop at www.kemppi.com or contact your dealer.

-  *Only an authorized electrician is allowed to carry out electrical work.*
-  *Only qualified service personnel is allowed to carry out periodic and annual maintenance.*
-  *Disconnect the power source from the mains before handling electrical cables and connectors.*
-  *Do not use pressure washing devices.*
-  *Where applicable, use the correct tension torque when fastening loose parts.*

Daily maintenance

- Check that all covers and components are intact.
- Check all the cables, hoses and connectors. Do not use them if they are damaged.
- Ensure that the connectors are correctly fastened. Loose connectors can impair operating performance and damage connectors.

Weekly maintenance

- Clean the outside parts of the units from dust and dirt, for example, with a soft brush and vacuum cleaner.
- Clean the ventilation grills. Do not use compressed air, there is a risk that the dirt will compact even more tightly into the gaps of the cooling profiles.
- If air filters are used, remove them and clean them by blowing with compressed air.

Periodic maintenance

Every 1–6 months:

- Check the electrical connectors of the equipment at least every 6 months. Clean oxidized parts and tighten loose connectors.

Annual maintenance

The annual maintenance must be carried out by an authorized Kemppi service workshop. Kemppi service workshops complete the equipment maintenance according to your Kemppi service agreement. Find your closest service workshop at www.kemppi.com.

Equipment's annual maintenance program includes:

- Cleaning the equipment.
- Maintenance of the gouging and welding tools.
- Checking the connectors and switches.
- Checking all electrical connections.
- Checking the power source mains cable and plug.
- Repairing defective parts and replacing defective components.
- Maintenance test.
- Testing the operation and calibrating the performance values when needed.
- Updating the equipment to the latest firmware and software versions.

6.2 Replacing and cleaning power source air filter

The X3G FastGouge 800 comes with the air filters preinstalled. The air filters are replaceable and they require cleansing periodically (depending on the operation environment). The air filter comes with a fixed casing designed to be mounted directly onto the power source air intake.

Tools needed:

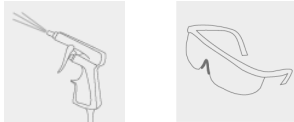

Replacement

1. Place the air filter assembly onto the power source air intake, and lock it in place with the clips on the edge of the casing. Repeat with the second air filter and air intake.

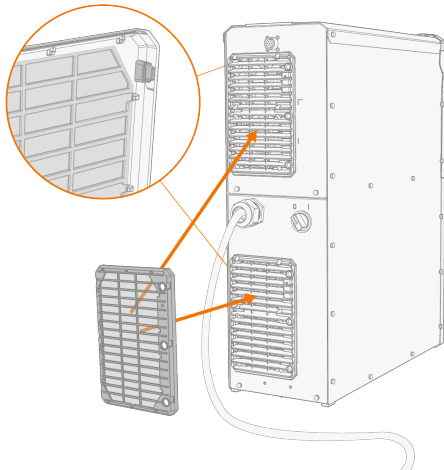

Cleansing

1. Remove the air filter from the power source by releasing the clips on the edge of the air filter casing.
2. Blow the air filter clean with compressed air.
3. Repeat with the second air filter.

6.3 Disposal



Do not dispose of any electrical equipment with normal waste!

In observance of WEEE Directive 2012/19/EU on waste of electrical and electronic equipment and European Directive 2011/65/EU on the restriction of the use of certain hazardous substances in electrical and electronic equipment, and their implementation in accordance with national law, electrical equipment that has reached the end of its life must be collected separately and taken to an appropriate environmentally responsible recycling facility. The owner of the equipment is obliged to deliver a decommissioned unit to a regional collection center, as per the instructions of local authorities or a Kemppi representative. By applying these European Directives you improve the environment and human health.

For more information:



7. TECHNICAL DATA

X3G FastGouge 800		
Feature		Value
Mains connection voltage		380...415 V \pm 10 %
Mains connection phases		3~50/60 Hz
Mains connection cable type		H07RN-F
Mains connection cable size		16 mm ²
Rated maximum input power [S_{1max}]		45 kVA
Mains fuse		63 A
Open circuit voltage [U_{av}]		100 V
Maximum supply current [I_{1max}]		67...62 A
Current adjustment		50...800 A
Power factor at rated maximum current	λ	0.87
Efficiency at rated maximum current	η	91 %
Minimum short-circuit power of supply network [S_{SC}]		6 MVA
Load capacity 50%		800 A
Load capacity 100%		600 A
Gouging carbon, maximum diameter		13 mm
Recommended compressed air pressure		5...7 kPa
Operating temperature range		-20...40 °C
Storage temperature range		-40...60 °C
EMC class		A
Degree of protection		IP23
External dimensions	<i>L x W x H</i>	730 x 268 x 796 mm
Weight without accessories		73 kg
Standards		IEC 60974-1, -10