

BesterMig 215-S

OPERATOR'S MANUAL



ENGLISH





THANK YOU! For choosing the **QUALITY** of the Lincoln Electric products.

- Please check packaging and equipment for damage. Claims for material damaged in shipment must be notified immediately to the dealer.
- For ease of use, please enter your product identification data in the table below. Model Name, Code & Serial Number can be found on the machine rating plate.

Model Name:	
.....	
Code & Serial number:	
.....
Date & Where Purchased:	
.....

ENGLISH INDEX

Technical Specifications	1
ECO design information	3
Electromagnetic Compatibility (EMC)	5
Safety	6
Introduction	8
Installation and Operator Instructions	8
WEEE	19
Spare Parts	19
Authorized Service Shops Location	19
Electrical Schematic	19
Accessories	20
Dimension Diagram	21

Technical Specifications

NAME		INDEX			
BesterMig 215-S		B18266-1			
INPUT					
	Input Voltage U ₁	EMC Class	Frequency		
BesterMig 215-S	230+15% /-10%, 1-phase	A	50/60Hz		
	Input Power at Rated Cycle	Input Amperes I _{1max}	PF		
BesterMig 215-S	10,5 kVA @ 10% Duty Cycle (40°C)	46 A	0,65		
RATED OUTPUT					
	Process	Open Circuit Voltage	Duty Cycle 40°C (based on a 10 min. period)	Output Current	Output Voltage
BesterMig 215-S	GMAW / FCAW	82Vdc	10%	200A*	24Vdc
			60%	82A	18,1Vdc
			100%	64A	17,2Vdc
	SMAW		10%	200A*	28Vdc
			60%	82A	23,3Vdc
			100%	64A	22,6Vdc
	GTAW (Lift TIG)		15%	200A*	18Vdc
			60%	100A	14Vdc
			100%	64A	12,6Vdc
WELDING CURRENT RANGE					
	GMAW / FCAW	SMAW	GTAW (Lift TIG)		
BesterMig 215-S	30A ÷ 200A	15A ÷ 200A	15A ÷ 200A		
RECOMMENDED INPUT CABLE AND FUSE SIZES					
	Fuse Type gR or Circuit Breaker Type D	Power Lead			
BesterMig 215-S	B 16A (B 25A)**	3 Conductor, 2,5mm ²			
WELDING VOLTAGE REGULATION RANGE					
	GMAW / FCAW	SMAW	GTAW (Lift TIG)		
BesterMig 215-S	15.5V ÷ 24V	20.6V ÷ 28V	16,5 V ÷ 26,5 V		
WIRE FEED SPEED RANGE / WIRE DIAMETER					
	WFS Range	Drive Rolls	Drive roll diameter		
BesterMig 215-S	2 ÷ 13m/min	1	Ø37		
	Solid Wires	Cored Wires			
BesterMig 215-S	0.6 ÷ 1.0 mm	0.8 ÷ 1.0 mm			
DIMENSION					
	Weight	Height	Width	Length	
BesterMig 215-S	28,4 kg	677 mm	370 mm	770 mm	
OTHERS					
	Protection Rating	Maximum Gas Pressure	Operating Humidity (t=20°C)		
BesterMig 215-S	IP21S	0,5MPa (5 bar)	≤ 90 %		
	Operating Temperature	Storage Temperature			
BesterMig 215-S	from -10°C to +40°C	from -25°C to 55°C			

(1) Based upon 10 minute time period (i.e., for 30% duty cycle, it is 3 minutes on and 7 minutes off)

NOTE: The above parameters are subject to change with the improvement of machine

*When welding with maximum current I₂>160A replace input plug with one>16A.

⚠ WARNING

While welding above 160A, You need to change overcurrent protection for a 20A - 25A type D and change for a proper input plug (or connect directly to a power network) Example:

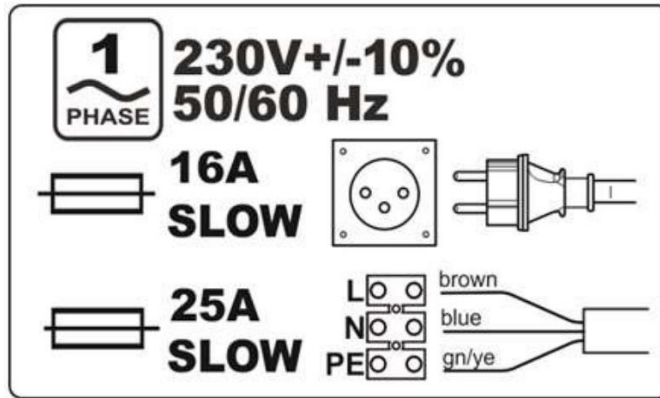

ECO design information

The equipment has been designed in order to be compliant with the Directive 2009/125/EC and the Regulation 2019/1784/EU.

Efficiency and idle power consumption:

Index	Name	Efficiency when max power consumption / Idle power consumption	Equivalent model
B18266-1	BesterMig 215-S	81% / 25W	No equivalent model

Idle state occurs under the condition specified in below table

IDLE STATE	
Condition	Presence
MIG mode	X
TIG mode	
STICK mode	
After 30 minutes of non-working	
Fan off	

The value of efficiency and consumption in idle state have been measured by method and conditions defined in the product standard EN 60974-1:20XX.

Manufacturer's name, product name, code number, product number, serial number and date of production can be read from rating plate.

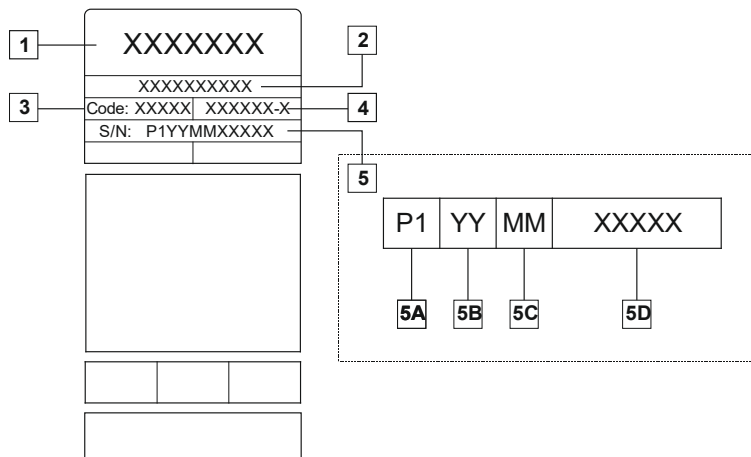

Where:

- 1- Manufacturer name and address
- 2- Product name
- 3- Code number
- 4- Product number
- 5- Serial number
 - 5A- country of production
 - 5B- year of production
 - 5C- month of production
 - 5D- progressive number different for each machine

Typical gas usage for **MIG/MAG** equipment:

Material type	Wire diameter [mm]	DC electrode positive		Wire Feeding [m/min]	Shielding Gas	Gas flow [l/min]
		Current [A]	Voltage [V]			
Carbon, low alloy steel	0,9 ÷ 1,1	95 ÷ 200	18 ÷ 22	3,5 – 6,5	Ar 75%, CO ₂ 25%	12
Aluminium	0,8 ÷ 1,6	90 ÷ 240	18 ÷ 26	5,5 – 9,5	Argon	14 ÷ 19
Austenitic stainless steel	0,8 ÷ 1,6	85 ÷ 300	21 ÷ 28	3 - 7	Ar 98%, O ₂ 2% / He 90%, Ar 7,5% CO ₂ 2,5%	14 ÷ 16
Copper alloy	0,9 ÷ 1,6	175 ÷ 385	23 ÷ 26	6 - 11	Argon	12 ÷ 16
Magnesium	1,6 ÷ 2,4	70 ÷ 335	16 ÷ 26	4 - 15	Argon	24 ÷ 28

TIG Process:

In TIG welding process, gas usage depends on cross-sectional area of the nozzle. For commonly used torches:

Helium: 14-24 l/min
Argon: 7-16 l/min

Notice: Excessive flow rates causes turbulence in the gas stream which may aspirate atmospheric contamination into the welding pool.

Notice: A cross wind or draft moving can disrupt the shielding gas coverage, in the interest of saving of protective gas use screen to block air flow.



End of life

At end of life of product, it has to be disposal for recycling in accordance with Directive 2012/19/EU (WEEE), information about the dismantling of product and Critical Raw Material (CRM) present in the product, can be found at <https://www.lincolnelectric.com/en-GB/Operators-Manuals>



Electromagnetic Compatibility (EMC)

11/04

This machine has been designed in accordance with all relevant directives and standards. However, it may still generate electromagnetic disturbances that can affect other systems like telecommunications (telephone, radio, and television) or other safety systems. These disturbances can cause safety problems in the affected systems. Read and understand this section to eliminate or reduce the amount of electromagnetic disturbance generated by this machine.



This machine has been designed to operate in an industrial area. To operate in a domestic area it is necessary to observe particular precautions to eliminate possible electromagnetic disturbances. The operator must install and operate this equipment as described in this manual. If any electromagnetic disturbances are detected the operator must put in place corrective actions to eliminate these disturbances with, if necessary, assistance from Lincoln Electric.

Before installing the machine, the operator must check the work area for any devices that may malfunction because of electromagnetic disturbances. Consider the following.

- Input and output cables, control cables, and telephone cables that are in or adjacent to the work area and the machine.
- Radio and/or television transmitters and receivers. Computers or computer controlled equipment.
- Safety and control equipment for industrial processes. Equipment for calibration and measurement.
- Personal medical devices like pacemakers and hearing aids.
- Check the electromagnetic immunity for equipment operating in or near the work area. The operator must be sure that all equipment in the area is compatible. This may require additional protection measures.
- The dimensions of the work area to consider will depend on the construction of the area and other activities that are taking place.

Consider the following guidelines to reduce electromagnetic emissions from the machine.

- Connect the machine to the input supply according to this manual. If disturbances occur it may be necessary to take additional precautions such as filtering the input supply.
- The output cables should be kept as short as possible and should be positioned together. If possible connect the work piece to ground in order to reduce the electromagnetic emissions. The operator must check that connecting the work piece to ground does not cause problems or unsafe operating conditions for personnel and equipment.
- Shielding of cables in the work area can reduce electromagnetic emissions. This may be necessary for special applications.

WARNING

The Class A equipment is not intended for use in residential locations where the electrical power is provided by the public low-voltage supply system. There may be potential difficulties in ensuring electromagnetic compatibility in those locations, due to conducted as well as radiated disturbances.













WARNING







This equipment does not comply with IEC 61000-3-12. If it is connected to a public low-voltage system, it is responsibility of the installer or user of the equipment to ensure, by consultation with the distribution network operator if necessary, that the equipment may be connected.



WARNING

This equipment must be used by qualified personnel. Be sure that all installation, operation, maintenance and repair procedures are performed only by qualified person. Read and understand this manual before operating this equipment. Failure to follow the instructions in this manual could cause serious personal injury, loss of life, or damage to this equipment. Read and understand the following explanations of the warning symbols. Lincoln Electric is not responsible for damages caused by improper installation, improper care or abnormal operation.

	<p>WARNING: This symbol indicates that instructions must be followed to avoid serious personal injury, loss of life, or damage to this equipment. Protect yourself and others from possible serious injury or death.</p>
	<p>WEAR CORRECT EYE, EAR & BODY PROTECTION: Protect your eyes and face with welding helmet properly fitted and with proper grade of filter plate. Protect your body from welding spatter and arc flash with protective clothing including woolen clothing, flame-proof apron and gloves, leather leggings, and high boots. Protect others from splatter, flash, and glare with protective screens or barriers. In some areas, protection from noise may be appropriate. Be sure protective equipment is in good condition. Also, wear safety glasses in work area at all times.</p>
	<p>READ AND UNDERSTAND INSTRUCTIONS: Read and understand this manual before operating this equipment. Arc welding can be hazardous. Failure to follow the instructions in this manual could cause serious personal injury, loss of life, or damage to this equipment.</p>
	<p>ELECTRIC SHOCK CAN KILL: Welding equipment generates high voltages. Do not touch the electrode, work clamp, or connected work pieces when this equipment is on. Insulate yourself from the electrode, work clamp and connected work pieces.</p>
	<p>ELECTRICALLY POWERED EQUIPMENT: Turn off input power using the disconnect switch at the fuse box before working on this equipment. Ground this equipment in accordance with local electrical regulations.</p>
	<p>ELECTRICALLY POWERED EQUIPMENT: Regularly inspect the input, electrode, and work clamp cables. If any insulation damage exists replace the cable immediately. Do not place the electrode holder directly on the welding table or any other surface in contact with the work clamp to avoid the risk of accidental arc ignition.</p>
	<p>ELECTRIC AND MAGNETIC FIELDS MAY BE DANGEROUS: Electric current flowing through any conductor creates electric and magnetic fields (EMF). EMF fields may interfere with some pacemakers and welders having a pacemaker shall consult their physician before operating this equipment.</p>
	<p>CE COMPLIANCE: This equipment complies with the European Community Directives.</p>
	<p>ARTIFICIAL OPTICAL RADIATION: According with the requirements in 2006/25/EC Directive and EN 12198 Standard, the equipment is a category 2. It makes mandatory the adoption of Personal Protective Equipment (PPE) having filter with a protection degree up to a maximum of 15, as required by EN169 Standard.</p>
	<p>FUMES AND GASES CAN BE DANGEROUS: Welding may produce fumes and gases hazardous to health. Avoid breathing these fumes and gases. To avoid these dangers the operator must use enough ventilation or exhaust to keep fumes and gases away from the breathing zone.</p>

	<p>ARC RAYS CAN BURN: Use a shield with the proper filter and cover plates to protect your eyes from sparks and the rays of the arc when welding or observing. Use suitable clothing made from durable flame-resistant material to protect your skin and that of your helpers. Protect other nearby personnel with suitable, non-flammable screening and warn them not to watch the arc nor expose themselves to the arc.</p>
	<p>WELDING SPARKS CAN CAUSE FIRE OR EXPLOSION: Remove fire hazards from the welding area and have a fire extinguisher readily available. Welding sparks and hot materials from the welding process can easily go through small cracks and openings to adjacent areas. Do not weld on any tanks, drums, containers, or material until the proper steps have been taken to insure that no flammable or toxic vapors will be present. Never operate this equipment when flammable gases, vapors or liquid combustibles are present.</p>
	<p>WELDED MATERIALS CAN BURN: Welding generates a large amount of heat. Hot surfaces and materials in work area can cause serious burns. Use gloves and pliers when touching or moving materials in the work area.</p>
	<p>CYLINDER MAY EXPLODE IF DAMAGED: Use only compressed gas cylinders containing the correct shielding gas for the process used and properly operating regulators designed for the gas and pressure used. Always keep cylinders in an upright position securely chained to a fixed support. Do not move or transport gas cylinders with the protection cap removed. Do not allow the electrode, electrode holder, work clamp or any other electrically live part to touch a gas cylinder. Gas cylinders must be located away from areas where they may be subjected to physical damage or the welding process including sparks and heat sources.</p>
	<p>MOVING PARTS ARE DANGEROUS: There are moving mechanical parts in this machine, which can cause serious injury. Keep your hands, body and clothing away from those parts during machine starting, operating and servicing.</p>
	<p>SAFETY MARK: This equipment is suitable for supplying power for welding operations carried out in an environment with increased hazard of electric shock.</p>

The manufacturer reserves the right to make changes and/or improvements in design without upgrade at the same time the operator's manual.

Introduction

The welding machines **BesterMig 215-S** enables welding:

- GMAW (MIG/MAG)
- FCAW-SS (Self-shielded wire)
- SMAW (MMA)
- GTAW (Lift TIG).

The complete package **BesterMig 215-S** contains:

- Work lead – 3m
- GMAW (MIG/MAG) welding gun – 3m
- SMAW (MMA) electrode holder – 3m.
- Driving rolls V0.6/V0.8 (mounted in the wire feeder)
- Gas hose – 2m.

Recommended equipment, which can be bought by user, was mentioned in the chapter "Accessories".

Installation and Operator Instructions

Read this entire section before installation or operation of the machine.

Location and Environment

This machine will operate in standard environments. However, it is important that simple preventative measures are followed to assure long life and reliable operation:

- Do not place or operate this machine on a surface with an incline greater than 10° from horizontal.
- Do not use this machine for pipe thawing.
- This machine must be located where there is free circulation of clean air without restrictions for air movement to and from the air vents. Do not cover the machine with paper, cloth or rags when switched on.
- Dirt and dust that can be drawn into the machine should be kept to a minimum.
- This machine has a protection rating of IP21S. Keep it dry when possible and do not place it on wet ground or in puddles.
- Do not use in rain or snow.
- Locate the machine away from radio controlled machinery. Normal operation may adversely affect the operation of nearby radio controlled machinery, which may result in injury or equipment damage. Read the section on electromagnetic compatibility in this manual.
- Do not operate in areas with an ambient temperature greater than 40°C.

Duty cycle and Overheating

The duty cycle of a welding machine is the percentage of time in a 10 minute cycle at which the welder can operate the machine at rated welding current.

Example: 60% duty cycle:

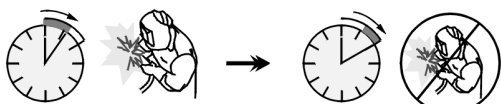

Welding for 6 minutes.

Break for 4 minutes.

Excessive extension of the duty cycle will cause the thermal protection circuit to activate.

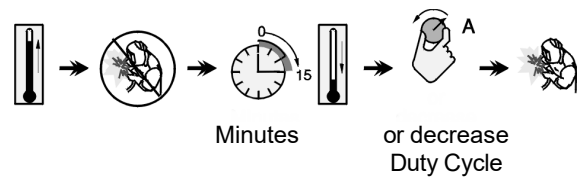

Input Supply Connection

⚠ WARNING

Only a qualified electrician can connect the welding machine to the supply network. Installation had to be made in accordance with the appropriate National Electrical Code and local regulations.

Check the input voltage, phase and frequency supplied to this machine before turning it on. Verify the connection of ground wires from the machine to the input source. The welding machine **BesterMig 215-S**, must be connected to a correctly installed plug-in socket with an earth pin.

Input voltage is 230V, 50/60Hz. For more information about input supply refer to the technical specification section of this manual and to the rating plate of the machine.

Make sure that the amount of mains power available from the input supply is adequate for normal operation of the machine. The necessary delayed fuse (or circuit breaker with "B" characteristic) and cable sizes are indicated in the technical specification section of this manual.

⚠ WARNING

The welding machine can be supplied from a power generator of output power at least 30% larger than input power of the welding machine.

⚠ WARNING

When powering welder from a generator be sure to turn off welder first, before generator is shut down, in order to prevent damage to welder!

Output Connections

Refer to points [1], [3] and [4] of the figures below.

Controls and Operational Features

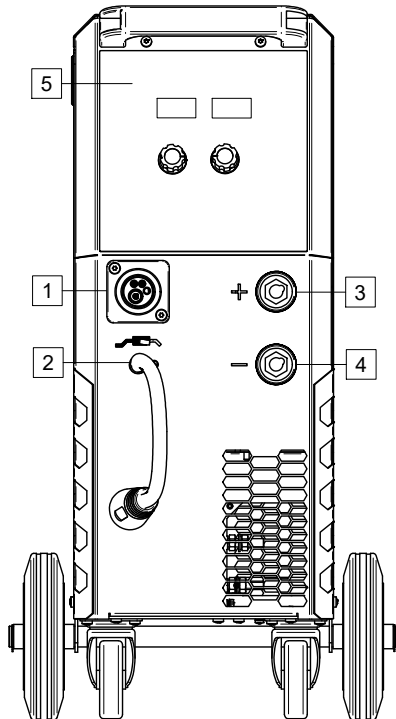

Figure 1

1. EURO Socket: For connecting a welding gun (for GMAW / FCAW processes).
2. Lead of Changing Polarity of EURO socket.
3. Positive Output Socket for the Welding Circuit: For connecting an electrode holder with lead / work lead depending on the require configuration. **+**
4. Negative Output Socket for the Welding Circuit: For connecting an electrode holder with lead / work lead depending on the require configuration. **—**
5. User Interface: See "User Interface" chapter.

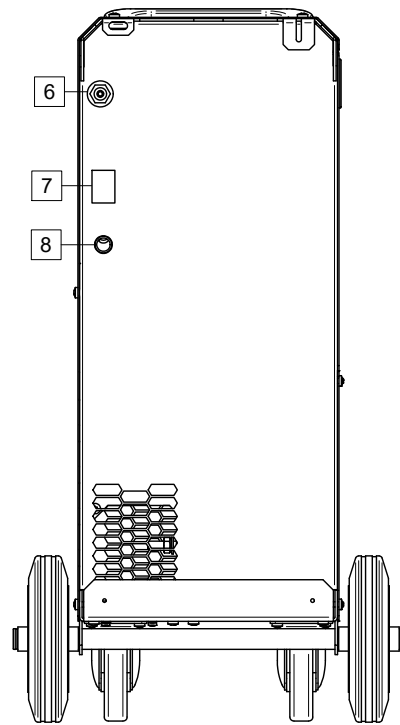

Figure 2

6. Gas Connector: Connection for gas line.
7. Power Switch ON/OFF (I/O): Controls the input power to the machine. Be sure the power source is connected to the mains supply before turning power on ("I").
8. Power Lead (2m): Connect the supply plug to the existing input cable that is rated for the machine as indicated in this manual, and conforms to all applicable standards. This connection shall be performed by a qualified person only.

⚠ WARNING

When the machine is switched again on, last welding process will be recalled.

⚠ WARNING

If the push-button is pushed in GMAW process in, the output terminals will lived.

⚠ WARNING

During SMAW process, the output terminals are still lived, after selecting this mode.

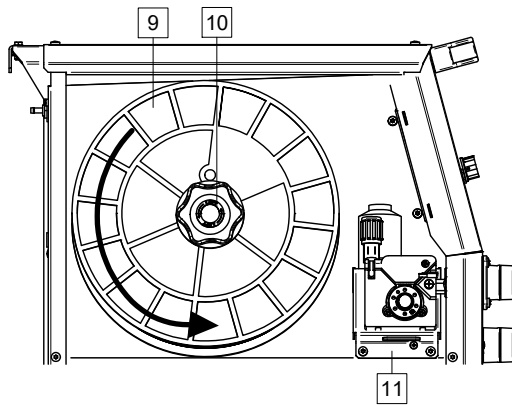

Figure 3



- 9. Spooled Wire (for GMAW / FCAW): Not supplied as standard.
- 10. Wire Spool Holder: Maximum 15kg spools. Maximum 300mm diameter spools. Holder allows mounting plastic, steel and fiber spools onto 51 mm spindle.
Note: Plastic Brake Nut has a Left-hand thread.
- 11. Wire drive: 1-roll wire drive.

User Interface







Figure 4



- 12. Left display: Shows value welding current, wire feed speed, Inductance and material thickness. During welding shows the actual welding current value.
- 13. Right display: Depending on the selected function and the welding process shows the welding voltage in volts, or voltage trim value or value of Arc Force. During welding shows the actual output welding voltage.
- 14. Input Power indicator: This LED lights up when the welding machine is ON and is ready to work.
- 15. Wire feed drive / Gas Purge: This switch allows wire feeding (wire test) and gas flow (gas test) without switching on the output voltage.
- 16. Torch Trigger Mode Button (2-Step/4-Step): Change the function of the torch trigger.

Process	Symbol	Description
		2-Step trigger operation turns welding on and off as direct response to the trigger. Welding process starts when the torch trigger is press.
		4-Step mode allows to continue welding, when the torch trigger is released. To stop welding, the torch trigger should be pressed again.4-step model facilitates to make long welds.

17. Welding Process Selection Button: Allow to choose the welding process:

Process	Symbol	Description
		Manual setting: GMAW (MIG/MAG). Welding parameters (wire feed speed and voltage) are selected by user.
		Synergy setting GMAW (MIG/MAG). Parameters welding (feeding speed wire and voltage) adjustable automatically after selecting gas, and wire.
	SMAW (MMA)	
	GTAW (Lift TIG)	

18. Gas Selection Button: Enables the selection of the type of shielding gas (for Synergic Mode only).









Process	Symbol	Description
	MIX	Choice of shielding gas or no gas.
	CO ₂	
		

19. Gas test button: This button allow initiate gas flow (gas test) without switching on the output voltage.

20. Wire Diameter or Manual Mode Selection Button: Sets the diameter of the welding wire for Synergic Mode.

Process	Symbol	Description
	0.6	Available wire diameter [mm] depends on choosing gas shielding type, type of wire and welding wire material.
	0.8	
	0.9	
	1.0	

21. Left Control: Click to select the Ampere /Wire feed speed / Inductance/ Material Thickness and turn to set the value of chosen parameter. Sets the value shown on the left display. Depending on welding process can be set:

Process	Symbol	Description
	m/min	Wire feed speed WFS: Nominal value wire feed speed (m/min).
		Inductance: Arc control is controlled by this knob. If the value is higher, the arc will be softer and during welding is less spatters.
	A	Current: Setup value output current in amperage [A].
	m/min	Wire feed speed WFS: Nominal value wire feed speed (m/min).
		Inductance: Arc control is controlled by this knob. If the value is higher, the arc will be softer and during welding is less spatters.
		Material thickness: Value in mm of welded material.
	A	Current: Setup value output current in amperage [A].
	A	Current: Setup value output current in amperage [A].

22. Voltage / Voltage trim / Arc Force encoder: Depending on welding process, this encoder controls:

GMAW process	V	Voltage. Allows you to adjust the welding voltage (also during the welding process)
GMAW process	V+/-	Voltage trim: during welding you can adjust voltage
SMAW process		ARC FORCE: The output current is temporarily increased to clear short circuit connections between the electrode and the work piece.

23. Thermal Overload Indicator: It indicates that the machine is overloaded or that the cooling is not sufficient.

Welding GMAW, FCAW-SS Process

BesterMig 215-S can be used to welding GMAW and FCAW-SS process.

Preparation the Machine for Welding GMAW and FCAW-SS Process.

Procedure of begin welding of GMAW or FCAW-SS process:

- Determine the wire polarity for the wire to be used. Consult the wire data for this information.
- Connect output the gas-cooled gun to GMAW / FCAW-SS process to Euro Socket [1] with the appropriate wire liner adapted to the type and diameter of the welding wire.
- Depending on the polarity of the welding wire used, attach the return cable to the output socket [3] or [4].
- Connect the work lead to the welding piece with the work clamp.
- Install the welding proper wire.
- Install the proper drive roll.
- Make a sure, if it is needed (GMAW process), that the gas shield has been connected.
- Turn the machine on.
- Push the gun trigger to feed the wire through the gun liner or the wire test button on the device panel [15] until the wire comes out of the threaded end.
- Install a proper contact tip.
- Depending on the welding process and the type of the gun, install the nozzle (GMAW process) or protection cap (FCAW-SS process).
- Close the left side panel.
- Set welding mode to GMAW [17].
- The welding machine is now ready to weld.
- By applying the principle of occupational health and safety at welding, welding can be begun.

Welding GMAW, FCAW-SS Process in Manual Mode

In **BesterMig 215-S** can be set:

- The welding load voltage
- Wire Feed Speed
- Inductance
- Material thickness

The 2-Step - 4-Step changes the function of the gun's trigger.

- 2 Step trigger operation turns welding on and off in direct response to the trigger. Welding process is performed when the gun's trigger is pulled.
- 4-Step mode allows to continue welding, when the gun's trigger is released. To stop welding, the gun's trigger is pulled again. 4-step mode facilitates to making long welds.

Welding SMAW (MMA) Process

BesterMig 215-S include the electrode holder with lead necessary for SMAW welding.

Procedure of begin welding of SMAW process:

- First turn the machine off.
- Determine the electrode polarity for the electrode to be used. Consult the electrode data for this information.
- Depending on the polarity of using electrode, connect the work lead and the electrode holder with lead to output socket [3] or [4] and lock them. See the Table 1.

Table 1

		OUTPUT SOCKET		
POLARITY	DC (+)	The electrode holder with lead to SMAW	[3]	+
		Work lead	[4]	-
	DC (-)	The electrode holder with lead to SMAW	[4]	-
		Work lead	[3]	+

- Connect the work lead to the welding piece with the work clamp.
- Install the proper electrode in the electrode holder.
- Turn the welding machine on.
- Set the welding parameters.
- The welding machine is now ready to weld.
- By applying the principle of occupational health and safety at welding, welding can be begun.

User can set functions:

- The welding current
- Arc dynamics ARC FORCE

Welding GTAW Process

BesterMig 215-S can be used to GTAW process with DC (-). Arc ignition can be achieved only by lift TIG method (contact ignition and lift ignition).

BesterMig 215-S does not include the torch to GTAW welding, but the one can be purchased separately. See "Accessories" chapter.

Procedure of begin welding of GTAW process:





- First turn the machine off.
- Connect GTAW torch to [4] output socket.
- Connect the work lead to [3] output socket.
- Connect the work lead to the welding piece with the work clamp.
- Install the proper tungsten electrode in the GTAW torch.
- Turn the machine on.
- Set up welding mode to GTAW [17]
- Set the welding parameters.
- The welding machine is now ready to weld.
- By applying the principle of occupational health and safety at welding, welding can be begun.

Welding GMAW Process in synergic mode

In synergic mode, the welding load voltage is not set by user. The correct welding load voltage will set by the machine's software.

The optimum output welding voltage is automatically set by the machine when changing the wire feed speed m/min or the output current value in A, depending on the selected workpoint. Table 2 below show all available synergic welding programs.

Table 2

Wire Diameter	Gas Type
	
0.6	CO ₂
0.8	CO ₂
0.9	CO ₂
1.0	CO ₂
0.6	MIX
0.8	MIX
0.9	MIX
1.0	MIX
0.8	
0.9	
1.0	

The installation and connection

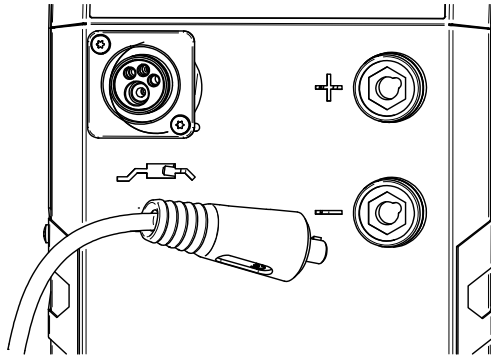

Figure 5

If the welding polarity has to be changed, user should:

- Switch off the machine.
- Determine the polarity for the electrode to be used (or wire). Consult the data for this information.
- Select and set the correct polarity: positive or negative.

WARNING

Before welding check the polarity for using electrodes and wires.

WARNING

The machine must be used with the door completely closed during welding.

WARNING

Not use handle to move the machine during work.

Loading the Electrode Wire

Depending on the type of wire spool it can be installed on the wire spool support without adapter or installed with use applicable adapter that must be purchased separately (see "Accessories" chapter).

WARNING

Turn the input power OFF at the welding power source before installation or changing a wire spool.

- Turn the machine off.
- Open the side cover of the machine.
- Unscrew the locking nut of the sleeve.
- Load the spool with the wire on the sleeve such that the spool turns anticlockwise when the wire is fed into the wire feeder.
- Make sure that the spool locating pin goes into the fitting hole on the spool.
- Screw in the fastening cap of the sleeve.
- Put on the wire roll using the correct groove corresponding to the wire diameter.
- Free the end of the wire and cut off the bent end making sure it has no burr.
- The device is adapted to the spool max. 300mm

WARNING

Sharp end of the wire can hurt.

- Rotate the wire spool anticlockwise and thread the end of the wire into the wire feeder as far as the Euro socket.
- Adjust force of pressure roll of the wire feeder properly.

Adjustments of Brake Torque of Sleeve

To avoid spontaneous unrolling of the welding wire the sleeve is fitted with a brake.

Adjustment is carried by rotation of its Allen screw M8, which is placed inside of the sleeve frame after unscrewing the fastening cap of the sleeve.

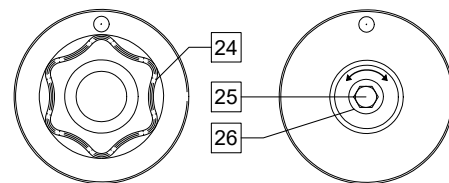

Figure 6

- 24. Fastening cap.
- 25. Adjusting Allen screw M8.
- 26. Pressing spring.

Turning the Allen screw M8 clockwise increases the spring tension and you can increase the brake torque

Turning the Allen screw M8 anticlockwise decreases the spring tension and you can decrease the brake torque.

After finishing of adjustment, you should screw in the fastening cap again.

Adjusting of Force of Pressure Roll Force

The pressure arm controls the amount of force the drive rolls exert on the wire.

Pressure force is adjusted by turning the adjustment nut clockwise to increase force, counterclockwise to decrease force. Proper adjustment of pressure arm gives the best welding performance.

WARNING

If the roll pressure is too low the roll will slide on the wire. If the roll pressure is set too high the wire may be deformed, which will cause feeding problems in the welding gun. The pressure force should be set properly. Decrease the pressure force slowly until the wire just begins to slide on the drive roll and then increase the force slightly by turning of the adjustment nut by one turn.

Changing Driving Rolls

WARNING

Turn the input power off of the welding power source before installation or changing drive rolls.

BesterMig 215-S is equipped with drive roll V0.8/V1.0 for steel wire. For others wire sizes, is available the proper drive rolls kit (see "Accessories" chapter) and follow instructions:

- Turn the input power OFF.
- Release the pressure roll lever [27].
- Unscrew the fastening cap [29].
- Change the drive roll [28] with the compatible ones corresponding to the used wire.

WARNING

Be sure that the gun liner and contact tip are also sized to match the selected wire size.

- Screw fastening cap [29].
- Manually feed the wire from the wire reel, the wire through the guide tubes, over the roller and guide tube of Euro Socket into liner of gun.
- Lock the pressure roll lever [27].

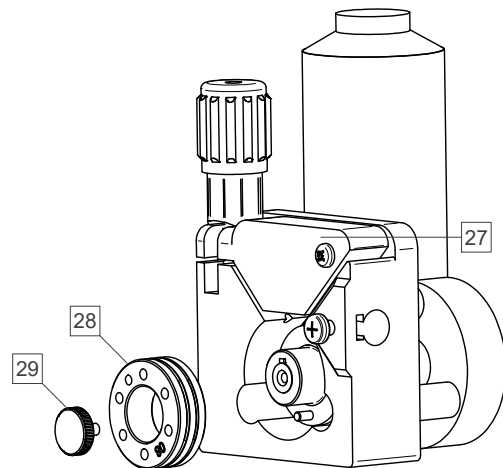

Figure 7

Gas Connection

A gas cylinder must be installed with a proper flow regulator. Once a gas cylinder with a flow regulator has been securely installed, connect the gas hose from the output of the regulator to the machine gas inlet connector.

WARNING

The welding machine supports all suitable shielding gases including carbon dioxide, argon and helium at a maximum pressure of 5,0 bars.

NOTE: When using the GTAW lift process, connect the gas hose from the GTAW torch to the gas regulator on the shield gas cylinder.

Transport and lifting



WARNING

Falling equipment can cause injury and damage to unit.

Do not use handle to lift or support unit.

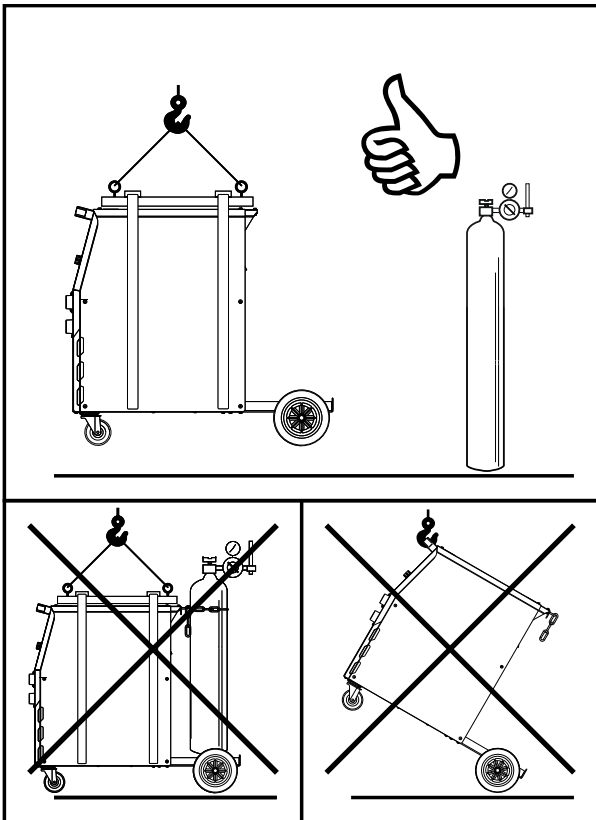

Figure 8

Maintenance

WARNING

For any repair operations, modifications or maintenances, it is recommended to contact the nearest Technical Service Center or Lincoln Electric. Repairs and modifications performed by unauthorized service or personnel will cause, that the manufacturer's warranty will become null and void.

Any noticeable damage should be reported immediately and repaired.

Routine maintenance (everyday)

- Check condition of insulation and connections of the work leads and insulation of power lead. If any insulation damage exists replace the lead immediately.
- Remove the spatters from the welding gun nozzle. Spatters could interfere with the shielding gas flow to the arc.
- Check the welding gun condition: replace it, if necessary.
- Check condition and operation of the cooling fan. Keep clean its airflow slots.

Periodic maintenance (every 200 working hours but at list once every year)

Perform the routine maintenance and, in addition:

- Keep the machine clean. Using a dry (and low pressure) airflow, remove the dust from the external case and from the cabinet inside.
- If it is required, clean and tighten all weld terminals.

The frequency of the maintenance operations may vary in accordance with the working environment where the machine is placed.

WARNING

Do not touch electrically live parts.

WARNING

Before the case of welding machine will be removed, the welding machine had to be turned off and the power lead had to be disconnected from mains socket.

WARNING

Mains supply network must be disconnected from the machine before each maintenance and service. After each repair, perform proper tests to ensure safety.

Customer Assistance Policy

The business of The Lincoln Electric Company is manufacturing and selling high quality welding equipment, consumables, and cutting equipment. Our challenge is to meet the needs of our customers and to exceed their expectations. On occasion, purchasers may ask Lincoln Electric for advice or information about their use of our products. We respond to our customers based on the best information in our possession at that time. Lincoln Electric is not in a position to warrant or guarantee such advice, and assumes no liability, with respect to such information or advice. We expressly disclaim any warranty of any kind, including any warranty of fitness for any customer's particular purpose, with respect to such information or advice. As a matter of practical consideration, we also cannot assume any responsibility for updating or correcting any such information or advice once it has been given, nor does the provision of information or advice create, expand or alter any warranty with respect to the sale of our products.

Lincoln Electric is a responsive manufacturer, but the selection and use of specific products sold by Lincoln Electric is solely within the control of, and remains the sole responsibility of the customer. Many variables beyond the control of Lincoln Electric affect the results obtained in applying these types of fabrication methods and service requirements.

Subject to Change – This information is accurate to the best of our knowledge at the time of printing. Please refer to www.lincolnelectric.com for any updated information.

Troubleshooting

No	Problem	Possible Cause	Recommended Course of Action
1	Yellow Thermal Indicator is on	<ul style="list-style-type: none"> Input voltage is too high ($\geq 15\%$) or Input voltage is too low ($\leq 15\%$) Insufficient ventilation Ambient temperature is too high Exceeding the rated duty-cycle. 	<ul style="list-style-type: none"> Switch off power source; check the main supply. Restart welder when power recovers to normal state Improve the ventilation It will automatically recover when the temperature reduces Stop working for a few minutes
2	Wire feed motor doesn't work	<ul style="list-style-type: none"> The potentiometer does not work Nozzle is blocked The drive roll does not feed the wire 	<ul style="list-style-type: none"> Change potentiometer Change nozzle Increase the pressure of the drive roller
3	Fan doesn't work or turns very slowly	<ul style="list-style-type: none"> Switch damaged Fan damaged Wire broken or disconnected 	<ul style="list-style-type: none"> Replace the switch Replace or repair the fan Check the connection
4	Arc doesn't stable and spatter is large	<ul style="list-style-type: none"> Incorrect or worn contact tip in the holder Too thin power lead makes the power unstable Too low input voltage Wire feeding resistance is too large 	<ul style="list-style-type: none"> Change to proper contact tip and / or drive roll Change the power cable Correct the input voltage Clean or replace the liner and keep the welding gun straight
5	The welding arc doesn't ignite	<ul style="list-style-type: none"> Work lead damaged The weldment is greasy, dirty, rusty or painted 	<ul style="list-style-type: none"> Repair or replace the work lead, check the connection Clean the weld material, ensure a good connection with the ground wire clamp
6	No gas flow	<ul style="list-style-type: none"> Torch is not connected properly Gas hose twisted or kinked Gas hose damaged 	<ul style="list-style-type: none"> Re-connect the torch Check gas system Repair or replace gas hose
7	Others		<ul style="list-style-type: none"> Please contact our Field Service Shop

WEEE

07/06



Do not dispose of electrical equipment together with normal waste!

In observance of European Directive 2012/19/EC on Waste Electrical and Electronic Equipment (WEEE) and its implementation in accordance with national law, electrical equipment that has reached the end of its life must be collected separately and returned to an environmentally compatible recycling facility. As the owner of the equipment, you should get information on approved collection systems from our local representative.

By applying this European Directive you will protect the environment and human health!

Spare Parts

12/05

Part List reading instructions

- Do not use this part list for a machine if its code number is not listed. Contact the Lincoln Electric Service Department for any code number not listed.
- Use the illustration of assembly page and the table below to determine where the part is located for your particular code machine.
- Use only the parts marked "X" in the column under the heading number called for in the assembly page (# indicate a change in this printing).

First, read the Part List reading instructions above, then refer to the "Spare Part" manual supplied with the machine that contains a picture-descriptive part number cross-reference.

Authorized Service Shops Location

09/16

- The purchaser must contact a Lincoln Authorized Service Facility (LASF) about any defect claimed under Lincoln's warranty period.
- Contact your local Lincoln Sales Representative for assistance in locating a LASF or go to www.lincolnelectric.com/en-gb/Support/Locator.

Electrical Schematic

Refer to the "Spare Part" manual supplied with the machine.

Accessories

OPTIONS & ACCESSORIES	
W10430-15-3M	LGS3 150 MIG GUN, GAS COOLED - 3m.
W10430-15-4M	LGS3 150 MIG GUN, GAS COOLED - 4m
W000010786	GAS NOZZLE CONICAL Ø12MM.
W000010820	CONTACT TIP M6x25MM ECU 0.6MM
W000010821	CONTACT TIP M6x25MM ECU 0.8mm
WP10440-09	CONTACT TIP M6x25MM ECU 0.9mm
W000010822	CONTACT TIP M6x25MM ECU 1.0mm
WP10468	PROTECTION CAP TO FCAW-SS PROCESS.
R-1019-125-1/08R	ADAPTER FOR SPOOL S200 (200mm)
K10158-1	ADAPTER FOR SPOOL TYPE B300
K10158	ADAPTER FOR SPOOL TYPE S300
W10529-17-4V	TIG TORCH WTT2 17- 4M WITH VALVE
E/H-200A-25-3M	WELDING CABLE WITH ELECTRODE HOLDER - 3m
W000260684	KIT (SET OF WELDING CABLES) FOR MMA PROCESS: 1. Electrode holder with lead to MMA process - 3m 2. Work lead with clamp - 3m
ROLL KIT FOR SOLID WIRES	
KP14016-0.8	DRIVE ROLL V0.6 / V0.8
KP14016-1.0	DRIVE ROLL V0.8 / V1.0 (Installed in standard)
ROLL KIT FOR CORED WIRES	
KP14016-1.1R	DRIVE ROLL VK0.9 / VK1.1
ROLL KIT FOR ALUMINIUM WIRES	
KP14016-1.2A	DRIVE ROLL U1.0 / U1.2

Dimension Diagram

