



USE AND MAINTENANCE MANUAL

TRANSLATION OF THE ORIGINAL INSTRUCTIONS — ENGLISH

COMPACT WELDERS

MAGIC WELD 200 YDE (STAGE V)

- Motosaldatrice
- Engine Driven Welder
- Motosoudeuse
- Motosoldadoras
- Schweißaggregat
- Motosoldadora
- По Вышкам

Codice
Code
Code
Codigo
Kodezahl
Código
Код

C0EP20009003

Edizione
Edition
Édition
Edición
Ausgabe
Edição
Издание

10.2019



MADE IN ITALY



MOSA Weld

0. GENERAL INFORMATION

M1.1	<i>INTRODUCTION</i>	PAG. 4
M1.4.2	<i>CE MARK</i>	PAG. 5
M2	<i>SYMBOLS AND SAFETY PRECAUTIONS</i>	PAG. 6
M2.1	<i>WARNINGS</i>	PAG. 7
M2.5...	<i>SAFETY RULES (ENGINE DRIVEN WELDERS)</i>	PAG. 8

1. GENERAL INFORMATION OF THE MACHINE

M0	<i>DESCRIPTION OF THE MACHINE</i>	PAG. 12
	<i>RECORDING DATA</i>	PAG. 13

2. DISPLACEMENTS AND TRANSPORT

M3	<i>MACHINE UNPACKING</i>	PAG. 14
M4.1	<i>TRANSPORT AND HANDLING</i>	PAG. 15

3. INSTALLATION AND USE

M2.7...	<i>INSTALLATION</i>	PAG. 16
M2.6	<i>INSTALLATION AND ADVICE</i>	PAG. 17
M20	<i>SET-UP FOR OPERATION</i>	PAG. 18
M21	<i>STARTING</i>	PAG. 19
M22	<i>STOPPING</i>	PAG. 20
M31	<i>CONTROLS</i>	PAG. 21
M34...	<i>USE AS WELDER</i>	PAG. 22
M37	<i>USE AS GENERATOR</i>	PAG. 23

4. INSTRUMENT AND USE

M39.6	<i>ENGINE PROTECTION</i>	PAG. 24
M55	<i>RACCOMANDED ELECTRODES</i>	PAG. 25

5. MAINTENANCE

M40.2...	<i>TROUBLE SHOOTING</i>	PAG. 26
M43	<i>MAINTENANCE</i>	PAG. 28
M45	<i>STORAGE AND CAST OFF</i>	PAG. 29

6. TECHNICAL INFORMATIONS

M1.5	<i>TECHNICAL DATA</i>	PAG. 30
M1.6	<i>TECHNICAL DATA (WELDING)</i>	PAG. 31
M2.7.1	<i>DIMENSIONS</i>	PAG. 32

Dear Customer,

We wish to thank you for having bought a high quality set. Our sections for Technical Service and Spare Parts will work at best to help you if it were necessary.

To this purpose we advise you, for all control and overhaul operations, to turn to the nearest authorized Service Centre, where you will obtain a prompt and specialized intervention.

☞ In case you do not profit on these Services and some arts are replaced, please ask and be sure that are used exclusively original parts; this to guarantee that the performances and the initial safety prescribed by the norms in force are re-established.

☞ **The use of non original spare parts will cancel immediately any guarantee and Technical Service obligation.**

NOTES ABOUT THE MANUAL

Before actioning the machine please read this manual attentively. Follow the instructions contained in it, in this way you will avoid inconveniences due to negligence, mistakes or incorrect maintenance. The manual is for qualified personnel, who knows the rules: about safety and health, installation and use of sets movable as well as fixed.

You must remember that, in case you have difficulties for use or installation or others, our Technical Service is always at your disposal for explanations or interventions.

The manual for Use Maintenance and Spare Parts is an integral part of the product. It must be kept with care during all the life of the product.

In case the machine and/or the set should be yielded to another user, this manual must also given to him.

Do not damage it, do not take parts away, do not tear pages and keep it in places protected from dampness and heat.

You must take into account that some figures contained in it want only to identify the described parts and therefore might not correspond to the machine in your possession.

INFORMATION OF GENERAL TYPE

In the envelope given together with the machine and/or set you will find: the manual for Use Maintenance and Spare Parts, the manual for use of the engine and the tools (if included in the equipment), the guarantee (in the countries where it is prescribed by law).

The Manufacturer shall not be liable for ANY USE OF THE PRODUCT OTHER THAN THAT PRECISELY SPECIFIED IN THIS MANUAL and is thus not liable for any risks which may occur as a result of IMPROPER USE. The Company does not assume any liability for any damage to persons, animals or property.

Our products are made in conformity with the safety norms in force, for which it is advisable to use all these devices or information so that the use does not bring damage to persons or things.

While working it is advisable to keep to the personal safety norms in force in the countries to which the product is destined (clothing, work tools, etc.).

Do not modify for any motive parts of the machine (fastenings, holes, electric or mechanical devices, others..) if not duly authorized in writing: the responsibility coming from any potential intervention will fall on the executioner as in fact he becomes maker of the machine.

☞ **NOTICE:** the manufacturer, who keeps the faculty, apart the essential characteristics of the model here described and illustrated, to bring betterments and modifications to parts and accessories, without putting this manual uptodate immediately.



Any of our product is labelled with CE marking attesting its conformity to applicable directives and also the fulfillment of safety requirements of the product itself; the list of these directives is part of the declaration of conformity included in any machine standard equipment.

Here below the adopted symbol:



CE marking is clearly readable and unerasable and it can be either part of the data-plate.

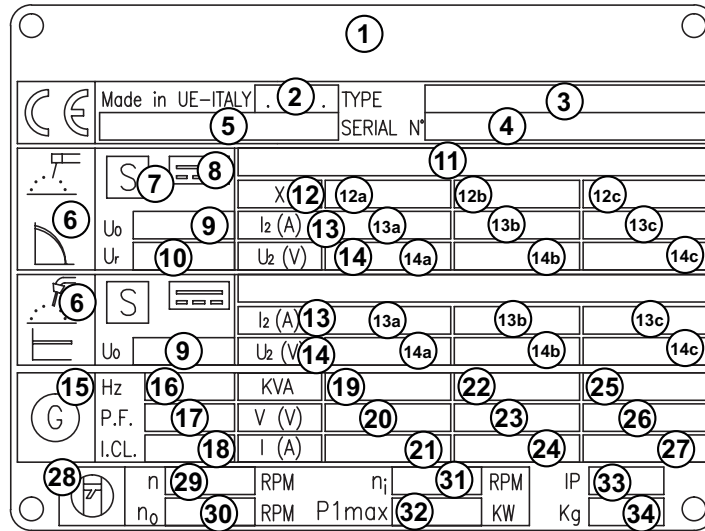

- | | | |
|---|---|--------------------------|
| 1. Manufacturer name or brand | 11. Maximum and minimum welding current values and relative voltage value | 18. Insulation class |
| 2. Year of production | 12. Duty cycle symbol | 19. Rated power (kVA/kW) |
| 3. Engine Driven Welder model | 12a. Duty cycle values | 20. Rated voltage (V) |
| 4. Serial number registration number | 12b. Duty cycle values | 21. Rated current (A) |
| 5. Reference to the standard confirming that the Engine Driven Welder complies with its requirements | 12c. Duty cycle values | 22. Rated power (kVA/kW) |
| 6. Welding process symbol | 13. Rated welding current symbol | 23. Rated voltage (V) |
| 7. Symbol for Engine Driven Welders which can be used an environment with increased risk of electric shock. | 13a. Rated welding current values | 24. Rated current (A) |
| 8. Welding current symbol | 13b. Rated welding current values | 25. Rated power (kVA/kW) |
| 9. OCV value (Rated no-load voltage) or adjustment range between minimum and maximum value | 13c. Rated welding current values | 26. Rated voltage (V) |
| 10. Reduced rated no-load voltage in case of a voltage reducing device (VRD) | 14. Conventional load voltage symbol | 27. Rated current (A) |
| | 14a. Welding voltage values | 28. Engine symbol |
| | 14b. Welding voltage values | 29. Rated speed |
| | 14c. Welding voltage values | 30. Rated no-load speed |
| | 15. Auxiliary power supply symbol | 31. Rated idle speed |
| | 16. Rated frequency | 32. Engine maximum power |
| | 17. Power factor $\cos\phi_p$ | 33. IP degree protection |
| | | 34. Dry weight (kg) |

Furthermore, on each model it is shown the noise level value; the symbol used is the following:

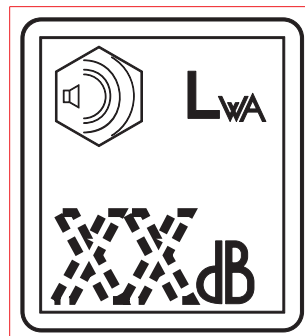







The indication is shown in a clear, readable and indeleble way on a sticker.

SYMBOLS IN THIS MANUAL

- The symbols used in this manual are designed to call your attention to important aspects of the operation of the machine as well as potential hazards and dangers for persons and things.
Moreover, this symbolism intends to draw your attention with the aim to give you indications for a correct use and, as a result, to obtain a good operation of the machine or equipment used.

SAFETY PRECAUTIONS

	DANGEROUS
This heading warns of an <u>immediate</u> danger for persons as well for things. Not following the advice can result in serious injury or death.	
	WARNING
This heading warns of situations which could result in injury for persons or damage to things.	
	CAUTION
To this advice can appear a danger for persons as well as for things, for which can appear situations bringing material damage to things.	
	IMPORTANT
	NOTE
	ATTENTION
These headings refer to information which will assist you in the correct use of the machine and/or accessories.	

SIMBOLS



STOP - Read absolutely and be duly attentive



Read and pay due attention



DANGER



GENERAL ADVICE - If the advice is not respected damage can happen to persons or things.



HIGH VOLTAGE - Attention High Voltage. There can be parts in voltage, dangerous to touch. The non observance of the advice implies life danger.



FIRE - Danger of flame or fire. If the advice is not respected fires can happen.



HEAT - Hot surfaces. If the advice is not respected burns or damage to things can be caused.



EXPLOSION - Explosive material or danger of explosion. in general. If the advice is not respected there can be explosions.



ACIDS - Danger of corrosion. If the advice is not respected the acids can cause corrosions with damage to persons or things.



PRESSION - Danger of burns caused by the expulsion of hot liquids under pressure.

PROHIBITIONS

It is prohibited to smoke while filling the tank with fuel.



The cigarette can cause fire or explosion. If the advice is not respected fires or explosions can be caused.

It is prohibited to use water to quench fires on the electric machine



If the advice is not respected fires or damage to persons can be caused.

Use only with non inserted voltage -



It is prohibited to make interventions before having disinserted the voltage.



ACCES FORBIDDEN to non authorized people.

ADVICE

Use only with safety clothing -



It is compulsory to use the personal protection means given in equipment.



WRENCH - Use of the tools. If the advice is not respected damage can be caused to things and even to persons.



FIRST AID. In case the operator should be sprayed by accident, from corrosive liquids a/o hot toxic gas or whatever event which may cause serious injuries or death, predispose the first aid in accordance with the ruling labour accident standards or of local instructions.

Skin contact	Wash with water and soap
Eyes contact	Irrigate with plenty of water, if the irritation persists contact a specialist
Ingestion	Do not induce vomit as to avoid the intake of vomit into the lungs, send for a doctor
Suction of liquids from lungs	If you suppose that vomit has entered the lungs (as in case of spontaneous vomit) take the subject to the hospital with the utmost urgency
Inhalation	In case of exposure to high concentration of vapours take immediately to a non polluted zone the person involved



FIRE PREVENTION. In case the working zone, for whatsoever cause goes on fire with flames liable to cause severe wounds or death, follow the first aid as described by the ruling norms or local ones.

EXTINCTION MEANS	
Appropriated	Carbonate anhydride (or carbon dioxide) powder, foam, nebulized water
Not to be used	Avoid the use of water jets
Other indications	Cover eventual shedding not on fire with foam or sand, use water jets to cool off the surfaces close to the fire
Particular protection	Wear an autorespiratory mask when heavy smoke is present
Useful warnings	Avoid, by appropriate means to have oil sprays over metallic hot surfaces or over electric contacts (switches, plugs, etc.). In case of oil sprinkling from pressure circuits, keep in mind that the inflamability point is very low.

GENERAL SAFETY INSTRUCTIONS

NOTE: the information contained in this manual are subject to change without notice.

The instructions in this manual are intended as indicative only. It is the responsibility of the owner/operator to evaluate risks and potential damages in relation to the use of the product in the specific conditions of application. Remember that the non observance of the indications of this manual may result in damage to people or things.

In all cases, however, it is understood that the use shall be in compliance with the applicable laws/regulations.

- Before operating the machine, read carefully the safety instructions contained in this manual and other manuals supplied (engine, alternator, etc.).
- All operations, handling, installation, use, maintenance, repair should be carried out by authorized and qualified personnel.
- When operating, wear personal protective equipment (PPE): footwear, gloves, helmet, etc..
- The owner is responsible for maintaining the equipment in safe conditions.

Use only in perfect technical conditions

The machinery or equipment must be used in perfect technical condition. Remove immediately any defects that may affect the safe conditions of use.

- Before starting to use this equipment it is important to take knowledge of all the controls of the machine, all its functions and its correct installation in order to avoid accidents to people and damage to the machine itself. In particular, it is important to know how to stop the equipment quickly in case of emergency.
- Do not allow the use of the machine to people unless previously instructed with all the information for a proper, safe use.
- Forbid the access in the operational area to non authorized personnel, children and pets so as to protect them from possible injury caused by any part of the machine.

SAFETY PRECAUTIONS DURING HANDLING AND TRANSPORTATION

- Lift the machine using only the points allocated for this function.
The lifting eye (or eyes) and the correct positioning of the forks of the forklift are marked with specific adhesives.
- Clear the operational area of possible obstacles and all unnecessary personnel.
- Always use lifting equipment properly sized and controlled by enabled bodies.
- It is forbidden to set on the frame of the equipment objects or accessories that alter weight and center of gravity and cause stresses not foreseen to the lifting points.
- Do not submit the machine and the lifting equipment to swinging or shock which may transmit dynamic stress to the structure.

Equipments with trailers or site tows

- Never drag the machine without trailer (or site tow)
- Check for a correct assembly of the machine to the towing device.
- Always make sure that the hook of the vehicle is suitable for towing of the total mass of the trailer.
- Do not tow the trailer if the coupling devices are worn or damaged.
- Check for proper tire pressure.

- Do not replace the tires with types different from the original ones.
- Check that the brakes and the optical signaling of the trailer are working properly.
- Verify that the bolts of the wheels are in place and well tightened.
- Do not park the machine (on trailer or site tow) on a steep slope.
For the stops, not followed by a work session, always engage the parking brake and / or block the wheels by means of wheel chocks.
- Do not tow the trailer on bumpy roads.
- Do not exceed the maximum permissible speed on public roads of 80 km/h with the trailer, in any case comply with the legislation applicable in the country of use.
- Do not use the site tow on public roads, this is intended for use only in private and delimited areas. The maximum permitted speed is 40 km/h on smooth surfaces (asphalt or concrete), adapt in each case the speed to the type of ground.

SAFETY PRECAUTIONS DURING INSTALLATION AND USE



Do not instal equipments closed to heat source, to explosion or fire risk area.

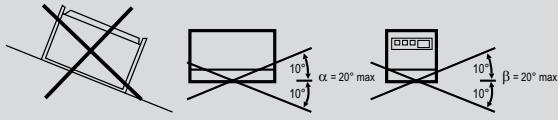

Always locate the machine on a flat and solid ground, so as to avoid tipping, slipping or falling during operation. Avoid using the machine on slopes greater than 10 degrees.

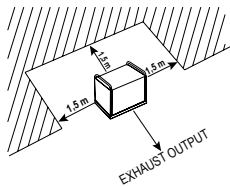

Make sure the area immediately surrounding the machine is clean and free from debris



Do not place objects or obstructions in the vicinity of the air intakes and air outlets, a possible overheating of the generator could cause a fire.



Connect the machine to an earthing system according to the regulations in force at the place of installation. Use the ground terminal on the front of the machine.

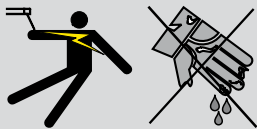

Do not use the machine with wet or damp hands and / or clothing. Use plugs suitable for the output sockets of the machine and make sure that electrical cords are in good condition.

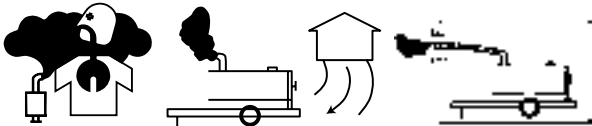

The machine must always be positioned so that the exhaust gases are dispersed in the air without being inhaled by people or living beings. If you use the machine indoors is necessary that the installation is designed and built by skilled technicians in a workmanlike manner.

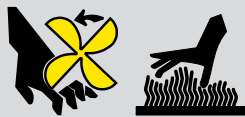

During normal operation, keep doors closed. The access to the internal parts should be allowed only for maintenance reasons.













Keep area near to the muffler free from objects such as rags, paper, cardboard. The high temperature of the muffler could cause the burning of objects and cause fire













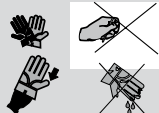

Immediately stop the machine in case of malfunction. Do not restart the machine without first having found and fixed the problem.

ENGLISH

ENGLISH

SAFETY PRECAUTIONS DURING MAINTENANCE	
Make use of qualified personnel to carry out maintenance and troubleshooting	
	It is mandatory to stop the engine before performing any maintenance on the machine.
	Always use protective devices and suitable equipment.
	Do not touch the engine, the exhaust pipes and the muffler during operation or immediately after. Allow the engine to cool before performing any operation
	With the machine running pay attention to moving parts such as fans, belts, pulleys. Do not remove the protections and the safety devices unless absolutely necessary, restore them after completion of the maintenance or repair.
	Do not refuel while the engine is running or hot. Do not smoke or use naked flames when refueling.
	Refuel only outdoors or in well ventilated areas. Avoid spilling fuel, especially on the engine. Clean and dry any leaks before restarting the machine
	Slowly unscrew the cap of the fuel tank and put it back always after refueling. Do not fill the tank completely to allow for expansion of the fuel inside
	Do not remove the radiator cap when the engine is running or still hot, the coolant may spurt out and cause serious burns
	Do not handle the battery without the use of protective gloves, the battery fluid contains sulfuric acid, which is very corrosive and dangerous
	Do not smoke, avoid any naked flames or sparks near the battery, the vapors exhaled could cause the battery to explode

ADDITIONAL REQUIREMENTS FOR ENGINE DRIVEN WELDERS

	<p>Do not touch parts with OCV, it can cause mortal shock or heavy born. OCV is active at welding stick and auxiliary side when welding generating set is working.</p>
	<p>Do not manage electric devices and welding stick whit feet, hands or wet dresses.</p>
	<p>Protect yourself from electric shock by insulating yourself from work and ground. Use non-flammable, dry insulating material if possible, or use dry rubber amts, dry wood or plywood, or other dry insulating material.</p>
	<p>Magnetic fields can affect pace-makers. Pace-maker wearers keep away from arc welding and cutting operations and equipment. Wearers should consult their doctor before going near arc welding, gouging, arc cutting, or spot welding operations.</p>
	<p>Breathing welding fumes can be hazardous to your health. Keep your out of the fumes</p>
	<p>Use enough ventilation, exhaust at the arc, or both, to keep fumes and gases from your breathing zone and the general area. If adequacy of ventilation or exhaust is uncertain, have the air quality checked.</p>
	<p>Arc rays can burn eyes and skin. Use welding helmet with correct shade of filter.</p>
	<p>While working protect your eyes using glasses with lateral screen and your head with dedicated cap; in case of restricted working area or unsafe working position also protect your ears.</p>
	<p>Wear complete body protection. Wear oil free protective clothing such as leather gloves, heavy shirt, cuffless pants, and hight boots.</p>
	<p>Welding can cause fire or explosion. Have a fire extinguisher nearby, and have a trained fire watcher ready to use it.</p>
	<p>Do not weld near flammable material. Move flammanles at least (10 m) away or protect them with flame-proof covers.</p>
	<p>Do not weld containers, structures, etc. with fammable materials inside (tank, cylinder, etc.); in case you need to weld, verify such items by qualified person in order to fully safely operate.</p>
	<p>Hot parts can cause severe burns. Don't touch the welder with bare hand. If handling is needed, use proper tools and/or wear heavy, insulated welding gloves to prevent burns. Allow cooling period before handing parts or working on gun or torch.</p>

The MAGIC WELD engine driven welder is a unit which ensures the dual function as:

- a) a current source for are welding
- b) current generator for generating auxiliary

Unit meant for industrial and professional use. Powered by an endothermic engine; it is composed of various parts such as: engine, alternator, electric and electronic controls, the fairing at a protective structure.

The assembling is made on a steel structure, on which are provided elastic support which must damp the vibrations and also eliminate sounds which would produce noise.

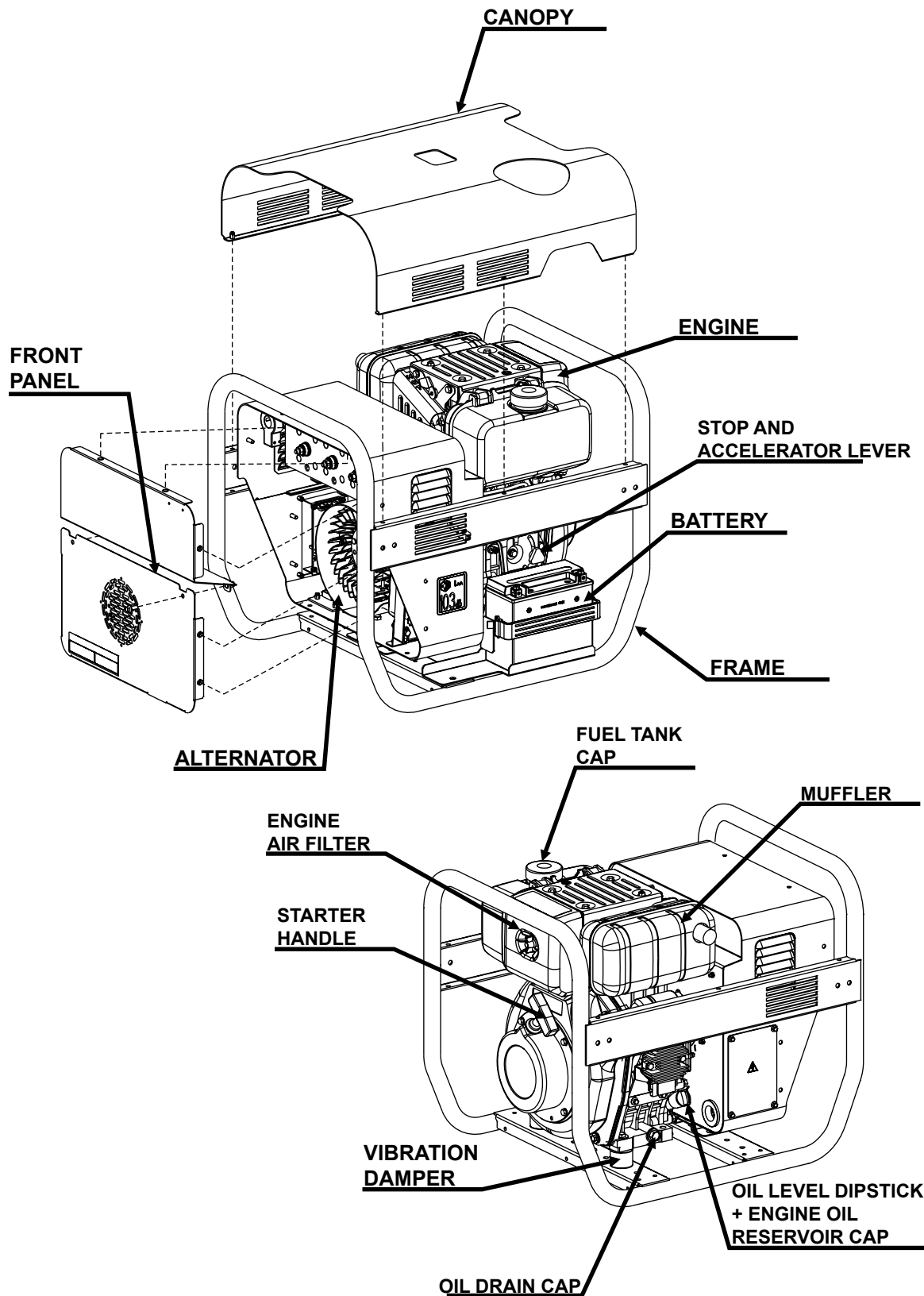

.....
The manual is for the range of machines indicated on the front cover.

With the scope to facilitate the search of the spare parts and maintain information of the bought machine, is necessary to record some data.

Please write the requested data inside the squares to side:

1. Model of machine
2. Serial number of the machine
3. Serial number of the engine
4. Name of the dealer where bought the machine
5. Address of the dealer
6. Phone number of the dealer
7. Date of the bought machine
8. Notes

RECORDING DATA

1. _____

2. _____

3. _____

4. _____

5. _____

6. _____

7. _____

8. _____



NOTE

ENGLISH

ENGLISH

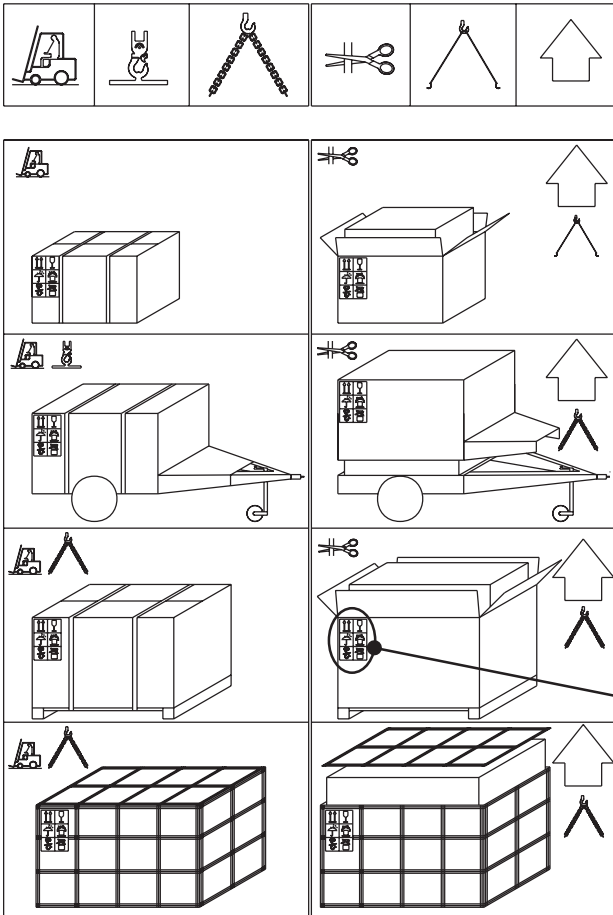

Be sure that the lifting devices are: correctly mounted, adequate for the weight of the machine with its packaging, and conforms to local rules and regulations. When receiving the goods make sure that the product has not suffered damage during the transport, that there has not been rough handling or taking away of parts contained inside the packing or in the set. In case you find damages, rough handling or absence of parts (envelopes, manuals, etc.), we advise you to inform immediately our Technical Service.



For eliminating the packing materials, the User must keep to the norms in force in his country.

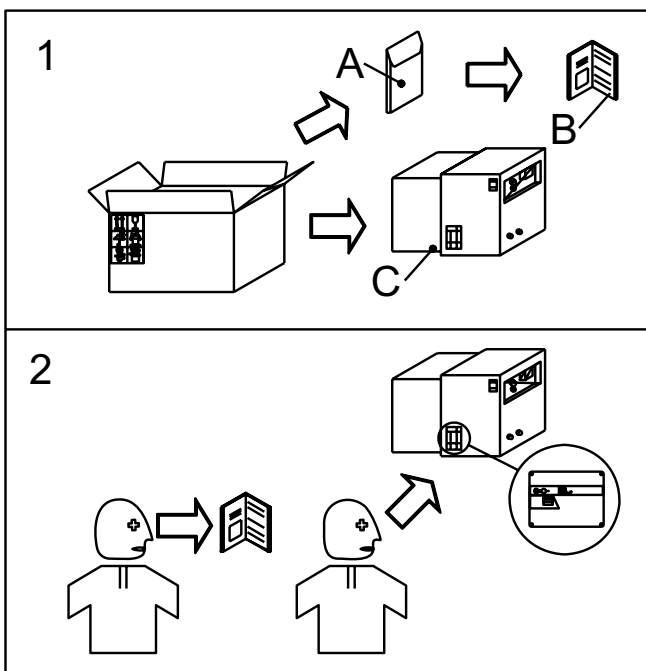
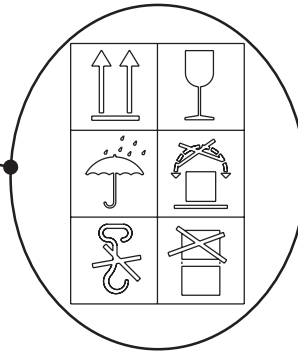

- 1) Take the machine (C) out of the shipment packing. Takeout of the envelope (A) the user's manual (B).
- 2) Read: the user's manual (B), the plates fixed on the machine, the data plate.





ATTENTION

Transportation must always take place with the engine off, electrical cables and starting battery disconnected and fuel tank empty. Be sure that the lifting devices are: correctly mounted, adequate for the weight of the machine with its packaging, and conform to local rules and regulations.

Only authorized persons involved in the transport of the machine should be in the area of movement.

DO NOT LOAD OTHER PARTS WHICH CAN MODIFY WEIGHT AND BARICENTER POSITION.

IT IS STRICTLY FORBIDDEN TO DRAG THE MACHINE MANUALLY OR TOW IT BY ANY VEHICLE (model with no CTM accessory).

If you did not keep to the instructions, you could damage the structure of the machine.

ENGLISH

ENGLISH

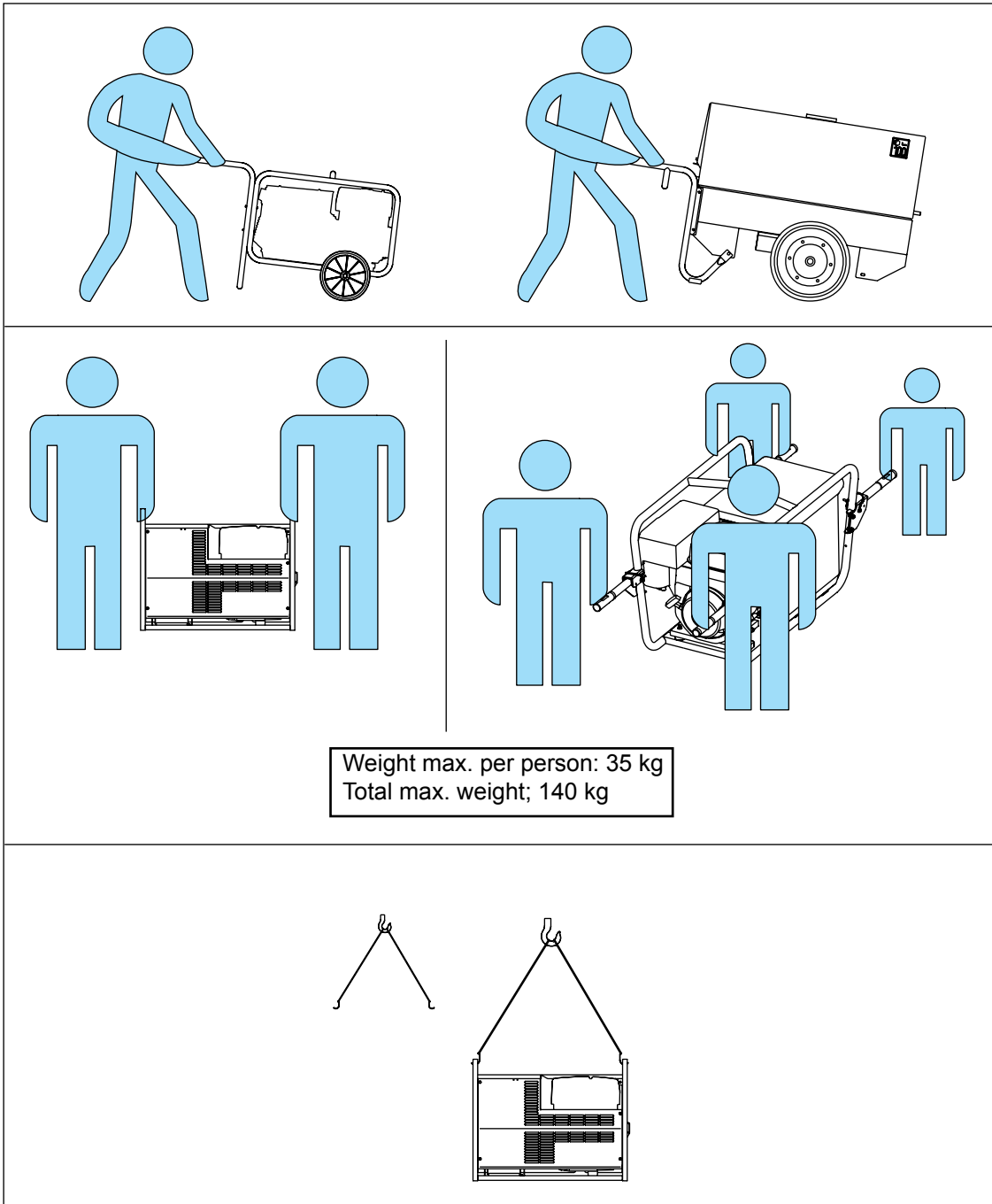

Weight max. per person: 35 kg
Total max. weight; 140 kg



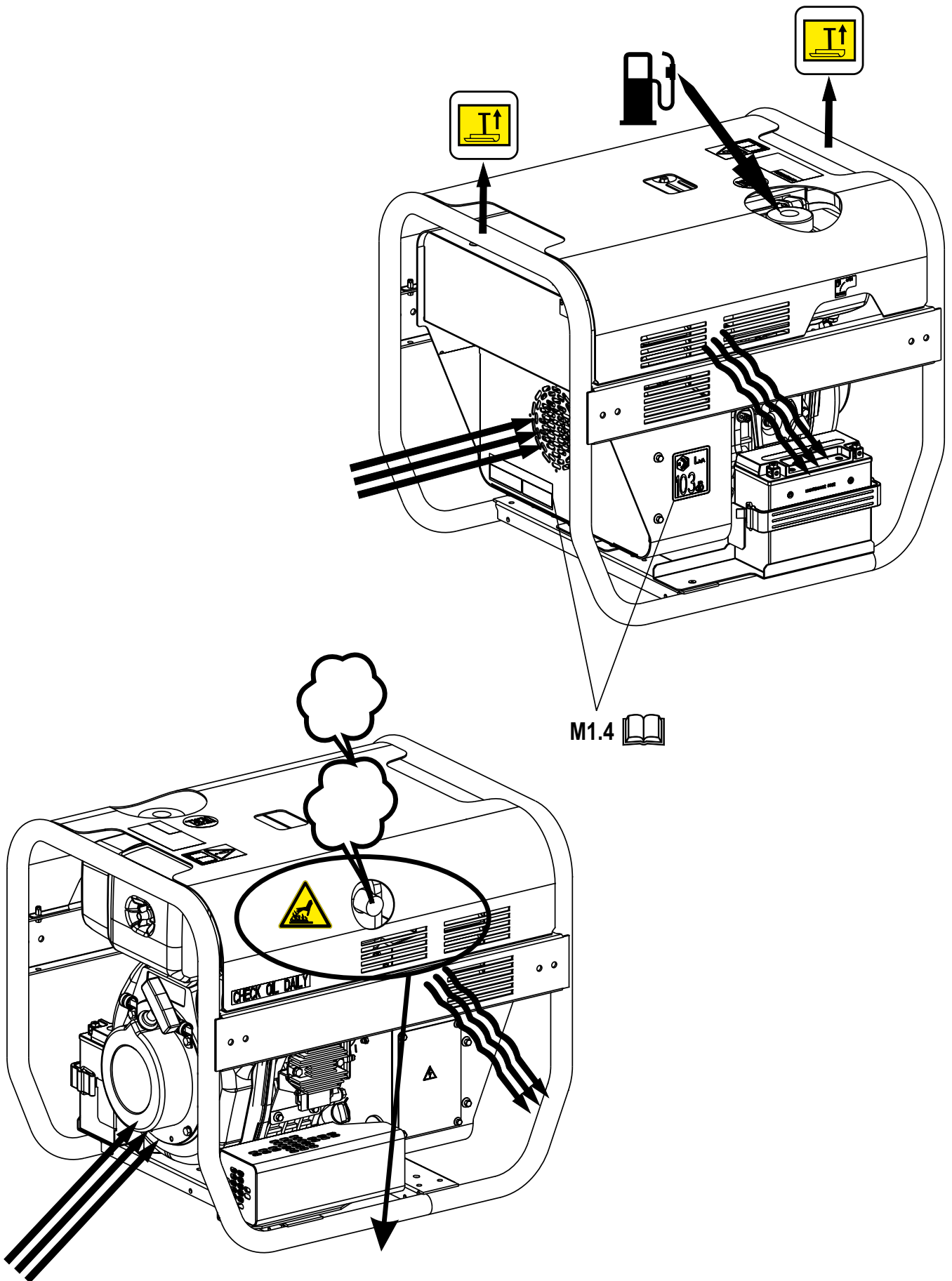

INSTALLATION AND ADVICE BEFORE USE

The operator of the welder is responsible for the security of the people who work with the welder and for those in the vicinity.

Before installing the welder machine, read the safety instruction of this manual at the chapter 2.5.

Particulary remember:

- installing operation must be made by authorized and qualified person.
- while installing operation use individual safety devices (shoes, gloves, cap, etc.)



DANGER



The machine must be positioned so that exhaust gas is diffused without being inhaled by any living being. Engine exhaust gas contains carbon monoxide, which is harmful to one's health, and in big quantities can cause intoxication and death. Local norms in force have to be respected.



ATTENTION



A safe distance has to be kept between the machine and fuel deposits, inflammable goods (cloths, paper, etc.), chemicals, according to indications provided by the authority in charge. In order to avoid potentially dangerous situations, area surrounding genset should be isolated so that unauthorized people will not be able to get close to the unit. Even if The machines are manufactured according to electromagnetic compatibility norms, we suggest NOT to install the genset near machinery that can be influenced by magnetic fields.



ATTENTION



This equipment is designed for outdoor use. It may be stored, but is not intended to be used when welding outside during precipitation unless sheltered

INSTALLATION

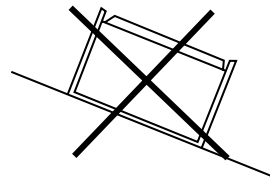

Always instal the welder machine on a hard and plan surface in order to avoid rollovers, slips or falls while working;
avoid to use the welder machine with slope more than 10°.

FIXING

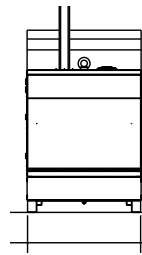

In order to absorb vibrations produced by genset, it should be fixed to a surface with sufficient rigidity, isolated against vibrations towards other structures and with a mass equal to at least three times the genset mass. If such above could not be possible, be sure that the welding machine do not move or slip while working due to vibrations; be care to fix the welder machine with dedicated tools.

MOVING THE WELDER MACHINE

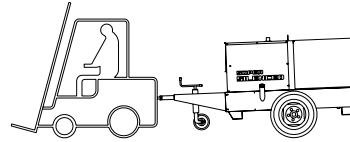

If is needed to move the welder machine be sure that the engine is off, that no electric connection is on and that noone cable will avoid to move the welder machine.

INSTALLATION ON VEHICLE

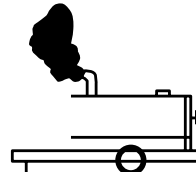

The wrong loads distribution can cause the instability of the vehicle and abnormalities to wheel and components. In case of transport need, use dedicated vehicle for this purpose. The loads must be balanced, fixed in order to guaranty the stability of the vehicle. Do not exceed the max load suitable of the vehicle with reference to axle, wheels, etc. Fix the base of welder machine at the frame or platform observing the instruction of the vehicle producer



**BATTERY WITHOUT MAINTENANCE****(WHERE IT IS ASSEMBLED)**

The included battery must be activated.

To activate it (fill the included acid) please follow the instructions shown on the manual attached to the battery.

When battery is activated, **DON'T** add any other liquid.

**LUBRICANT**

Please refer to the motor operating manual for the recommended viscosity.

REFUELLING AND CONTROL:

Carry out refuelling and controls with motor at level position.

1. Remove the oil-fill tap (24)
2. Pour oil and replace the tap
3. Check the oil level using the dipstick (23); the oil level must be comprised between the minimum and maximum indicators.

**ATTENTION**

It is dangerous to fill the motor with too much oil, as its combustion can provoke a sudden increase in rotation speed.

**DRY AIR FILTER**

Check that the dry air filter is correctly installed and that there are no leaks around the filter which could lead to infiltrations of non-filtered air to the inside of the motor.

**FUEL****ATTENTION**

Stop engine when fueling. Do not smoke or use open flames during refuelling operations, in order to avoid explosions or fire hazards.



Fuel fumes are highly toxic; carry out operations outdoors only, or in a well-ventilated environment. Avoid accidentally spilling fuel. Clean any eventual leaks before starting up motor.

Refill the tank with good quality diesel fuel, such as automobile type diesel fuel, for example.

For further details on the type of diesel fuel to use, see the motor operating manual supplied.

Do not fill the tank completely; leave a space of approx. 10 mm between the fuel level and the wall of the tank to allow for expansion.

In rigid environmental temperature conditions, use special winterized diesel fuels or specific additives in order to avoid the formation of paraffin.

**GROUNDING CONNECTION**

See section "Use as a generator" page M37.



Check daily

**NOTE**

Do not alter the primary conditions of regulation and do not touch the sealed parts.

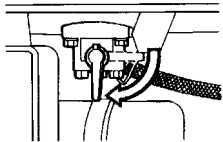
RECOIL VERSION

1) Open fuel cock

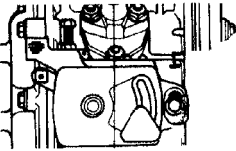

2) Accelerator lever must be in the "START" position



3) Grasp the starter handle as shown



4) Pull the starter rope until you feel resistance and let it return slowly to its original position

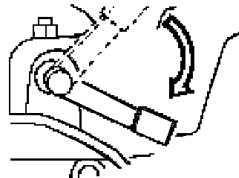
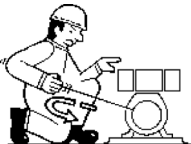

5) lower the decompression lever



6) pull the rope firmly as far as it will go. If necessary use two hands

ELECTRIC STARTING

1) Carry out operations 1) and 5) as with pull start

2) Turn the starter key to the "ON" position, the accelerator control solenoid will automatically move the accelerator lever into the "START" position

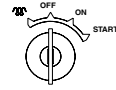

3) Turn the starter key to the "START" position, when the motor is running, let the key reposition itself to "ON"

4) When the motor is started, it will immediately reach the nominal RPM for approx. 6/7 seconds, after which time it will automatically go down to the minimum set by the solenoid which controls the accelerator lever.

5) When welding power or auxiliary generation is required, the motor will automatically go up to the nominal RPM necessary for the use of the machine.

EMERGENCY PULL START FOR ELECTRIC STARTER VERSIONS**WARNING**

The pull start, for electric starter versions, is only possible if the all the conditions listed below have been met:

- the starter battery must remain connected to the electrical circuit;
- the starter battery must be able to power the accelerator control solenoid, check this condition turning the starter key to the "ON" position;
- unplug the pressure switch cable.

If all the above conditions have been met, proceed as follows:

- 1) Open fuel cock
- 2) Turn the starter key into the "ON" position, check that the accelerator control solenoid moves the accelerator lever into the "START" position
- 3) Grasp the starter handle as shown
- 4) Pull the starter rope until you feel resistance and let it return slowly to its original position
- 5) lower the decompression lever
- 6) pull the rope firmly as far as it will go. If necessary use two hands.



- ☞ Before stopping the engine it is **compulsory** to stop the load:
- stop welding;

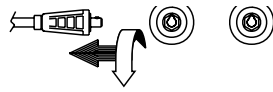

- shut off any loads which are connected to the unit auxiliary outputs.

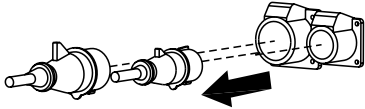

RECOIL VERSION

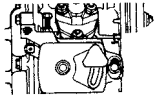

- Let the motor run at no load for several minutes to allow for cooling and then move the accelerator control into the "STOP" position.

ELECTRIC STARTING

- Wait for the motor to automatically go to the minimum RPM, 6/7 seconds after load release, leave the motor running under these conditions for several minutes in order to allow for cooling, then turn the starting key to the "OFF" position.

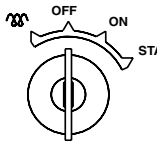

ATTENTION

To switch off the motor in case of emergency, either move the accelerator control to the "STOP" position immediately or move the starter key to the "OFF" position.

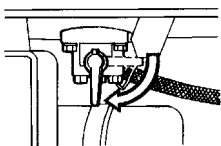

Shut the fuel cock.

- ☞ **NB.:** for safety purposes remove the starter key from the machine at the end of every work session.

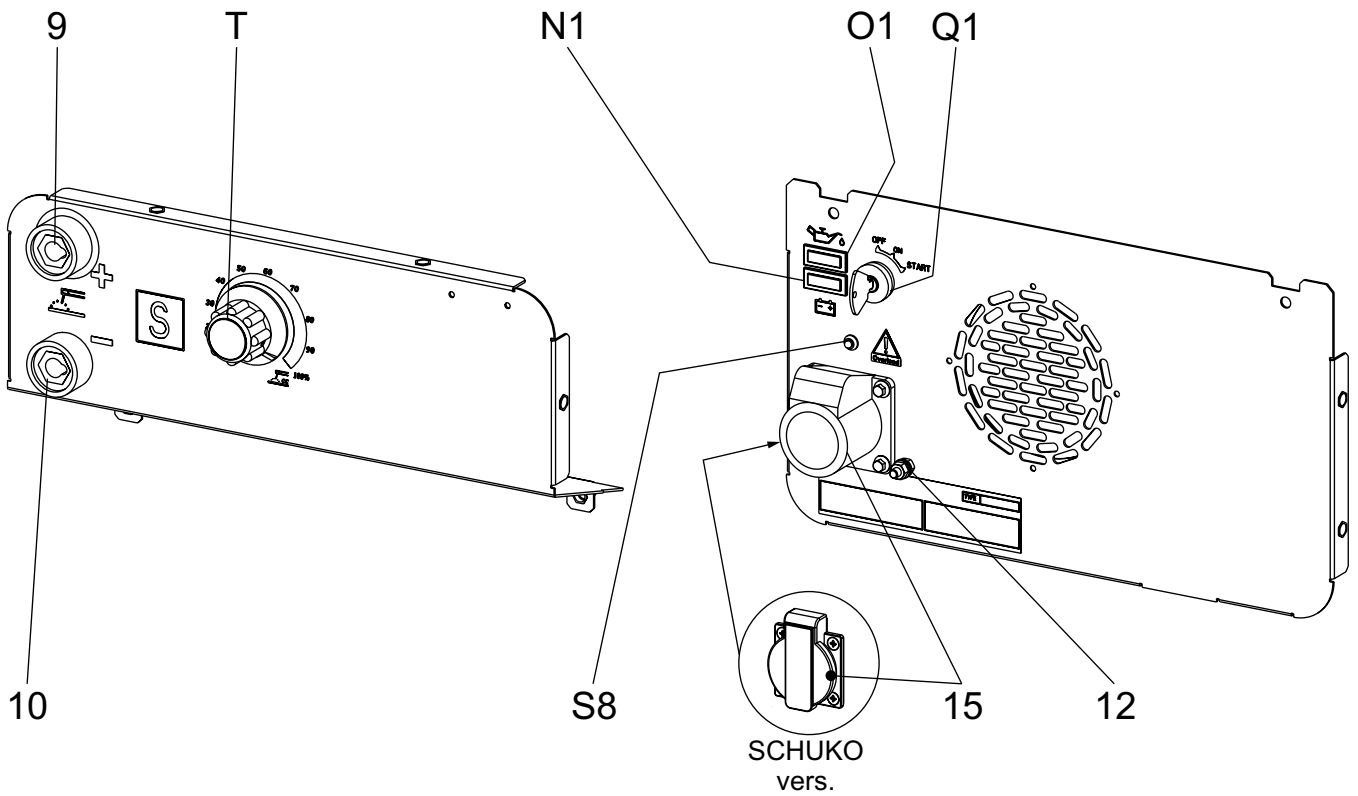

POS.	DESCRIZIONE	DESCRIPTION	DESCRIPTION	REFERENZLISTE
9	Prese di saldatura (+)	Welding sockets (+)	Prises de soudage (+)	Schweißbuchse (+)
10	Prese di saldatura (-)	Welding sockets (-)	Prises de soudage (-)	Schweißbuchse (-)
12	Presa di messa a terra	Earth terminal	Prise de mise à terre	Erdanschluß
15	Presa di corrente in c.a.	A.C. socket	Prises de courant en c.a.	Steckdose AC
N1	Spia carica batteria	Battery charge warning light	Voyant charge batterie	Kontrolleuchte Batterielader
O1	Spia bassa pressione olio	Oil pressure warning light	Voyant lumineux pression huile	Kontrolleuchte Oeldruck
Q1	Chiave di avviamento	Starter key	Clé de démarrage	Zündschloß
S8	Led di sovraccarico	Overload led	Led Overload (surcharge)	LED Overload
T	Regolatore corrente di saldatura	Welding current regulator	Régulateur courant soudage	Schweißstromregler



This symbol (Norm EN 60974-1 security standards for arc welders) signifies that the welders can be used in areas with increased risk of electrical shock.

**ATTENTION**

It is prohibited for any unauthorized persons to access areas adjacent to the engine driven welder or the welding process.

**ATTENTION**

To reduce the risk of electromagnetic interference, keep the welding cable length short and keep them on or near the ground. If possible, welding operations should not be done near sensitive electronic devices. If interference continues to occur, adopt additional measures: shift the group, use shielded cables, line filters, shield the entire work area. If the above solutions do not suffice, consult our Technical Servicing Department.

**ATTENTION**

With a welding cable length up to 10 m is suggested a section of 35 mm²; with longer cables a bigger section is required.

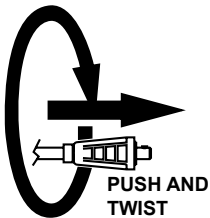
CONNECT WELDING CABLES

Fully insert the welding cable plugs into the corresponding sockets turning them clockwise to lock them in position.



Ensure that ground clamp, whose cable must be connected to the (-) socket or the (+) socket, according to the type of electrode, makes good contact and that, if possible, it is close

to the welding position. Pay attention to the two polarities of the welding circuit, which must not come into electrical contact with each other.

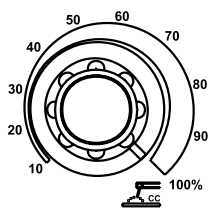
ADJUSTING THE WELDING CURRENT

The welding current is regulated by turning knob "T" continuously. If set to the minimum (turned fully in an anticlockwise direction) it provides a current of approximately 30 A; if set to the maximum (turned fully in a clockwise direction) it gives a maximum current of approximately 200A (20V).

AUTO IDLE – ECONOMISER (only for version YDE)**Operation**

When the engine is switched on it immediately reaches a maximum speed of 3720 rpm for approximately 6/7 seconds for easy start up, after which it automatically decreases and idles at 2650 rpm. It remains at this speed until current is drawn when set to weld or auxiliary power. When set to weld mode the machine reaches maximum engine speed as soon as there is minimum contact between the tip of the electrode and the piece to be welded and also when set to generation drawing a minimum of 250 - 300 W.

The machine returns to minimum 6/7 seconds later if power is not drawn during welding or generation.



**ATTENTION**

It is absolutely forbidden to connect the unit to the public mains and/or another electrical power source.

**ATTENTION**

It is prohibited for any unauthorized persons to access areas adjacent to engine driven welder.

ENGLISH

ENGLISH

AUXILIARY GENERATION IN AC 230V/50Hz

The auxiliary output is drawn by means of a 3 pole socket, the two poles are live, phase and neutral, plus the earth for the machine.

The single phase generation of the machine was designed to supply small power tools (grinders, drills etc.) to assist the welding operations with a quick, safe connection without the need to connect to earth. In addition, supplying only one tool at a time, the protection against indirect contact is assured by "electrical separation".

Therefore, the machine **MUST NOT** be intentionally connected to earth, attaching cables must be of 3 wires and the electrical equipment on which it being used must have an extension length limited to 100-200 metres. This limitation of circuit extension length is fundamental for safety.

The cables must be SUITED to the environment in which they are to be used. Bear in mind that at temperatures below 5°C PVC cables become rigid and the PVC insulation tends to split at the first crease.

Using double insulated equipment is advisable, this is identifiable by the symbol  and for having no earth facility.

If the machine is designed to supply circuits which are particularly complex or in an area with potential electrical risk, it is required to interpose a complete electrical distribution panel, equipped with all electrical protections required, between the plug and loads.

For example: you can use a distribution system TN-S. In this case one of the phases, used as a neutral must be grounded; a bipolar 30mA differential switch (GFI) must be mounted inside the electrical box, before the sockets to which loads are connected; the terminal in the frontal panel of the generating set near the socket is to be used as earth connection, wiring it to the ground of the electrical plant with which the machine is going to work.

WARNING: bound the neutral to frame BEFORE the GFI.



The engine is equipped with system protection (stop) in the event the oil pressure is too low.

In the event of a malfunction in the battery charging system, the warning light will come on without stopping the engine.



The information here below are to be intended only as indicative since the above norm is much larger.
For further details please see the specific norms and/or the manufacturers of the product to be used in the welding process.

RUTILE ELECTRODES: E 6013

Easily removable fluid slag, suitable for welding in all position.
Rutile electrodes weld in d.c. with both polarities (electrode holder at + or -) and in a.c..
Suitable for soft steels R-38/45 kg/mm². Also for soft steels of lower quality.

BASIC ELECTRODES: E 7015

Basic electrodes weld only in d.c. with inverse polarity (+ on the electrode holder) ; there are also types for a.c.
Suitable for impure carbon steels. Weld in all position.

HIGH YIELD BASIC ELECTRODES: E 7018

The iron contained in the coating increases the quality of metal added. Good mechanical properties. Weld in all position. Electrode holder at + (inverse polarity). Weld deposit of nice aspect, also vertical. Workable; high yield.
Suitable for steels with high contents of sulphur (impurities).

CELLULOSIC ELECTRODES: E 6010

Cellulosic electrodes weld only in d.c. with polarity + electrode holder - ground clamp.
Special for steels run on pipes with R max 55 kg/mm². Weld in all position. volatile slag.

ELECTRODES IDENTIFICATION ACCORDING TO A.W.S. STANDARDS

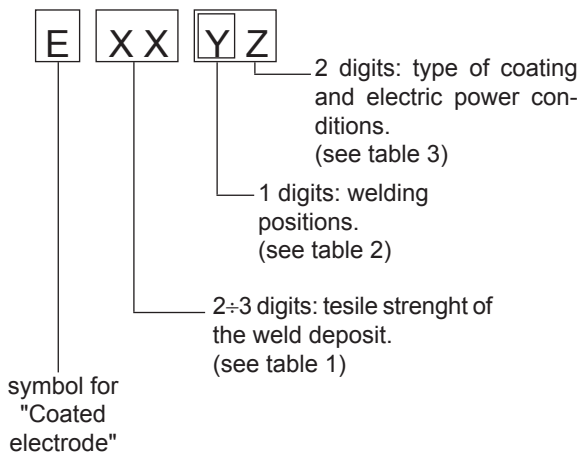

Number	Strength	
	K.s.l.	Kg/mm ²
60	60.000	42
70	70.000	49
80	80.000	56
90	90.000	63
100	100.000	70
110	110.000	77
120	120.000	84

Table 1

1	for all positions
2	for plane and vertical
3	for plane position only



Table 2

N°	Description
10	Cellulose electrodes for d.c.
11	Cellulose electrodes for a.c.
12	Rutile electrode for d.c.
13	Rutile electrode for a.c.
14	High yield rutile electrodes
15	Basic electrodes for d.c.
16	Basic electrodes for c.a.
18	High yield basic electrodes for d.c. (inverse polarity)
20	Acid electrodes for flat or front position welding for d.c. (- pole) and for a.c.
24	High yield rutile electrodes for flat or front plane position welding for d.c. and a.c.
27	High yield acid electrodes for flat or front plane position welding for d.c. (- pole) and a.c..
28	High yield basic electrodes for flat or front plane position welding for d.c. (inverse polarity)
30	Extra high yield acid electrodes, extra high penetration if required, for flat position welding only for d.c. (- pole) and a.c.

Table 3

<i>Problem</i>	<i>Possible cause</i>	<i>Solution</i>
ENGINE		
The motor does not start up, or starts up and then stops immediately	<ol style="list-style-type: none"> 1) Lack of fuel in tank 2) Air in the fuel circuit 3) Incorrect position of accelerator control knob 4) Battery low 5) Battery cable terminals loose or corroded 6) Start-up motor defective 7) Faulty starter key 8) Faulty emergency stop of engine 9) Malfunction on electrical power circuit 10) Malfunction on feed circuit: defective pump, injector blocked 11) Air filter or fuel filter clogged 12) Other causes 	<ol style="list-style-type: none"> 1) Refill tank 2) Check power supply circuit 3) Check position 4) Recharge or replace. Check the battery charge circuit. 5) Tighten and clean. Replace if corroded. 6) Repair or replace. 7) Replace 8) Replace 9) Check and repair 10) Ask for intervention of Service Department. 11) Clean or replace 12) Consult instruction and maintenance manual of the engine.
The motor does not accelerate. Inconstant speed.	<ol style="list-style-type: none"> 1) Air filter or fuel filter clogged. 2) Malfunction on feed circuit: defective pump, injector blocked. 3) Oil level too high. 4) Motor speed regulator defective. 	<ol style="list-style-type: none"> 1) Clean or replace. 2) Ask for intervention of Service Department. 3) Eliminate excess oil. 4) Ask for intervention of Service Department
Black smoke	<ol style="list-style-type: none"> 1) Air filter clogged. 2) Overload. 3) Injectors defective. Injection pump requires calibration. 	<ol style="list-style-type: none"> 1) Clean or replace 2) Check the load connected and diminish. 3) Ask for intervention of Service Department.
White smoke	<ol style="list-style-type: none"> 1) Oil level too high. 2) Motor cold or in prolonged operation with little or no load. 3) Segments and/or cylinders worn out. 	<ol style="list-style-type: none"> 1) Eliminate excess oil. 2) Insert load only with motor sufficiently hot 3) Ask for intervention of Service Department.
Too little power provided by motor.	<ol style="list-style-type: none"> 1) Air filter clogged. 2) Insufficient fuel distribution, impurities or water in feed circuit. 3) Injectors dirty or defective. 	<ol style="list-style-type: none"> 1) Clean or replace. 2) Check the feed circuit, clean and refill once again. 3) Ask for intervention of Service Department.
Low oil pressure	<ol style="list-style-type: none"> 1) Oil level insufficient 2) Air filter clogged. 3) Oil pump defective. 4) Alarm malfunction. 	<ol style="list-style-type: none"> 1) Reset level. Check for leaks. 2) Replace filter. 3) Ask for intervention of Service Department. 4) Check the sensor and electrical circuit.

<i>Problem</i>	<i>Possible cause</i>	<i>Solution</i>
WELDING CIRCUIT		
No current under no-load conditions in weld mode	<ol style="list-style-type: none"> 1) Faulty welding control board 2) Faulty Hall sensor 	<ol style="list-style-type: none"> 1) With a voltmeter check that between pins A (-) and B (+) of the circular connector on the front panel there is 5 Vdc. Ask for intervention of Service Department to replace the board. 2) Ask for intervention of Service Department to replace the Hall sensor.
Irregular or inconsistent welding current	<ol style="list-style-type: none"> 1) Faulty welding control board 2) Faulty Hall sensor 3) Chopper bridge short circuit 	<ol style="list-style-type: none"> 1) With a voltmeter check that between pins A (-) and B (+) of the circular connector on the front panel there is 5 Vdc. Ask for intervention of Service Department to replace the board. 2) Ask for intervention of Service Department to replace the Hall sensor. 3) Ask for intervention of Service Department to replace the Chopper Bridge.
Engine always at idle speed. Engine always at maximum speed	<ol style="list-style-type: none"> 1) Faulty welding control board 2) Fault to the Auto Idle - Economizer system 	<ol style="list-style-type: none"> 1) With a voltmeter check that between pins A (-) and B (+) of the circular connector on the front panel there is 5 Vdc. Ask for intervention of Service Department to replace the board. 2) Ask for intervention of Service Department
AUXILIARY POWER GENERATION CIRCUIT		
No current under no-load conditions in auxiliary power mode	<ol style="list-style-type: none"> 1) Auxiliary power diode bridge broken 2) Faulty inverter 3) Faulty alternator 	Ask for intervention of Service Department

 WARNING		
	<ul style="list-style-type: none"> • Have qualified personnel do maintenance and troubleshooting work. • Stop the engine before doing any work inside the machine. If for any reason the machine must be operated while working inside, pay attention moving parts, hot parts (exhaust manifold and muffler, etc.) electrical parts which may be unprotected when the machine is open. • Remove guards only when necessary to perform maintenance, and replace them when the maintenance requiring their removal is complete. • Please wear the appropriate clothing and make use of the PPE (Personal Protective Equipment), according to the type of intervention (protective gloves, insulated gloves, glasses). • Do not modify the components if not authorized. <p>- See pag. M1.1 -</p>	
MOVING PARTS can injure		HOT surface can hurt you

NOTE

By maintenance at care of the utilizer we intend all the operatios concerning the verification of mechanical parts, electrical parts and of the fluids subject to use or consumption during the normal operation of the machine.

For what concerns the fluids we must consider as maintenance even the periodical change and or the refills eventually necessary.

Maintenance operations also include machine cleaning operations when carried out on a periodic basis outside of the normal work cycle.

The repairs **cannot be considered** among the maintenance activities, i.e. the replacement of parts subject to occasional damages and the replacement of electric and mechanic components consumed in normal use, by the Assistance Authorized Center as well as by manufacturer.

The replacement of tires (for machines equipped with trolleys) must be considered as repair since it is not delivered as standard equipment any lifting system.

The periodic maintenance should be performed according to the schedule shown in the engine manual. An optional hour counter (M) is available to simplify the determination of the working hours.

VENTILATION

Make certain there are no obstructions (rags, leaves or other) in the air inlet and outlet openings on the machine, alternator and motor.

ELECTRICAL PANELS

Check condition of cables and connections daily. Clean periodically using a vacuum cleaner, **DO NOT USE COMPRESSED AIR.**

DECALS AND LABELS

*All warning and decals should be checked once a year and **replaced** if missing or unreadable.*

STRENUOUS OPERATING CONDITIONS



Under extreme operating conditions (frequent stops and starts, dusty environment, cold weather, extended periods of no load operation, fuel with over 0.5% sulphur content) do maintenance more frequently.

**BATTERY WITHOUT MAINTENANCE
DO NOT OPEN THE BATTERY**

The battery is charged automatically from the battery charger circuit supplied with the engine.

Check the state of the battery from the colour of the warning light which is in the upper part.

- Green colour: battery OK
- Black colour: battery to be recharged
- White colour: battery to be replaced

 IMPORTANT
 <p>In the maintenance operations avoid that polluting substances, liquids, exhausted oils, etc. bring damage to people or things or can cause negative effects to surroundings, health or safety respecting completely the laws and/or dispositions in force in the place.</p>

ENGINE AND ALTERNATOR

PLEASE REFER TO THE SPECIFIC MANUALS PROVIDED.

Every engine and alternator manufacturer has maintenance intervals and specific checks for each model: it is necessary to consult the specific engine or alternator USER AND MAINTENANCE manual.

 NOTE
<p>THE ENGINE PROTECTION NOT WORK WHEN THE OIL IS OF LOW QUALITY BECAUSE NOT CHARGED REGULARLY AT INTERVALS AS PRESCRIBED IN THE OWNER'S ENGINE MANUAL.</p>



STORAGE

In case the machine should not be used for more than 30 days, make sure that the room in which it is stored presents a suitable shelter from heat sources, weather changes or anything which can cause rust, corrosion or damages to the machine.

☛ Have **qualified** personnel prepare the machine for storage.

GASOLINE ENGINE

Start the engine: It will run until it stops due to the lack of fuel.

Drain the oil from the engine sump and fill it with new oil (see page M25).

Pour about 10 cc of oil into the spark plug hole and screw the spark plug, after having rotated the crankshaft several times.

Rotate the crankshaft slowly until you feel a certain compression, then leave it.

In case the battery, for the electric start, is assembled, disconnect it.

Clean the covers and all the other parts of the machine carefully.

Protect the machine with a plastic hood and store it in a dry place.

DIESEL ENGINE

For short periods of time it is advisable, about every 10 days, to make the machine work with load for 15-30 minutes, for a correct distribution of the lubricant, to recharge the battery and to prevent any possible blocking of the injection system.

For long periods of inactivity, turn to the after sales service of the engine manufacturer.

Clean the covers and all the other parts of the machine carefully.

Protect the machine with a plastic hood and store it in a dry place.

DISASSEMBLE

☛ Have **qualified** personnel disassemble the machine and dispose of the parts, including the oil, fuel, etc., in a correct manner when it is to be taken out of service.

As disassemble we intend all operations to be made, at utilizer's care, at the end of the use of the machine.

This comprises the dismantling of the machine, the subdivision of the several components for a further reutilization or for getting rid of them, the eventual packing and transportation of the eliminated parts up to their delivery to the store, or to the bureau entrusted to the disassemble or to the storage office, etc.

The several operations concerning the disassemble, involve the manipulation of fluids potentially dangerous such as: lubricating oil and battery electrolyte.

The dismantling of metallic parts liable to cause injuries or wounds, must be made wearing heavy gloves and using suitable tools.

The getting rid of the various components of the machine must be made accordingly to rules in force of law a/o local rules.

Particular attention must be paid when getting rid of: lubricating oils, battery electrolyte, and inflammable liquids such as fuel, cooling liquid.

The machine user is responsible for the observance of the norms concerning the environment conditions with regard to the elimination of the machine being disassemble and of all its components.

In case the machine should be disassemble without any previous disassembly it is however compulsory to remove:

- tank fuel
- engine lubricating oil
- cooling liquid from the engine
- battery

NOTE: The manufacturer is involved with disassembling the machine **only** for the second hand ones, when not reparable.

This, of course, after authorization.

In case of necessity for first aid and fire prevention, see page M2.1.

**IMPORTANT**

In the storage and cust off operations avoid that polluting substances, liquids, exhausted oils, etc. bring damage to people or things or can cause negative effects to surroundings, health or safety respecting completely the laws and/or dispositions in force in the place.



A.C. GENERATION 50/60 Hz		MAGIC WELD 200 YDE
Single-phase output 230V (max)		3.3 kVA / 230 V / 14.3 A
Single-phase output 230V (continuous)		3 kVA / 230 V / 13 A
Single-phase output 115V (max)		2.1 kVA / 110 V / 18.3A
Single-phase output 115V (continuous)		1.8 kVA / 110 V / 16.4 A
Cos φ		0.8
ALTERNATOR		self-excited, brushless
Type		permanent magnet
Insulating class		H
ENGINE		
Mark / Model		YANMAR L70 (STAGE V)
Type / Cooling system		Diesel 4-stroke / Air
Cylinders / Displacement		1 / 320 cm ³
Max power		4.9 kW (6.7 HP)
Speed		3600 rpm
Fuel consumption (Welding 60%)		1 l/h
Engine oil capacity		1.05 l
Starter		Electric
GENERAL SPECIFICATIONS		
Tank capacity		3.3 l
Running time (Welding 60%)		3.3 h
Protection		IP 23
*Dimensions max. LxIhx		630x490x540
*Weight		91 Kg
Acoustic power LwA (pressure LpA)		103 dB(A) (78 dB(A) @ 7 m)

** Dimensions and weight are inclusive of all parts without wheels and towbar*

POWER

Declared power according to ISO 3046-1 (temperature 25°C, 30% relative humidity, altitude 100 m above sea level).

It's admitted overload of 10% each hour every 12 h.

In an **approximative** way one reduces: of 1% every 100 m altitude and of 2.5% for every 5°C above 25°C.

ACOUSTIC POWER LEVEL

ATTENTION: The concrete risk due to the machine depends on the conditions in which it is used. Therefore, it is up to the end-user and under his direct responsibility to make a correct evaluation of the same risk and to adopt specific precautions (for instance, adopting a I.P.D. -Individual Protection Device)

Acoustic Noise Level (LwA) - Measure Unit dB(A): it stands for acoustic noise released in a certain delay of time. This is not submitted to the distance of measurement.

Acoustic Pressure (Lp) - Measure Unit dB(A): it measures the pressure originated by sound waves emission. Its value changes in proportion to the distance of measurement.

The here below table shows examples of acoustic pressure (Lp) at different distances from a machine with Acoustic Noise Level (LwA) of 95 dB(A)

Lp a 1 meter = 95 dB(A) - 8 dB(A) = 87 dB(A)

Lp a 7 meters = 95 dB(A) - 25 dB(A) = 70 dB(A)

Lp a 4 meters = 95 dB(A) - 20 dB(A) = 75 dB(A)

Lp a 10 meters = 95 dB(A) - 28 dB(A) = 67 dB(A)

PLEASE NOTE: the symbol  when with acoustic noise values, indicates that the device respects noise emission limits according to 2000/14/CE directive.

D.C. WELDING	MAGIC WELD 200 Y
Current range, continuous	20 - 200A
Open circuit voltage	65V
Duty cycle	200 A - 60%

OUTPUT CHARACTERISTIC

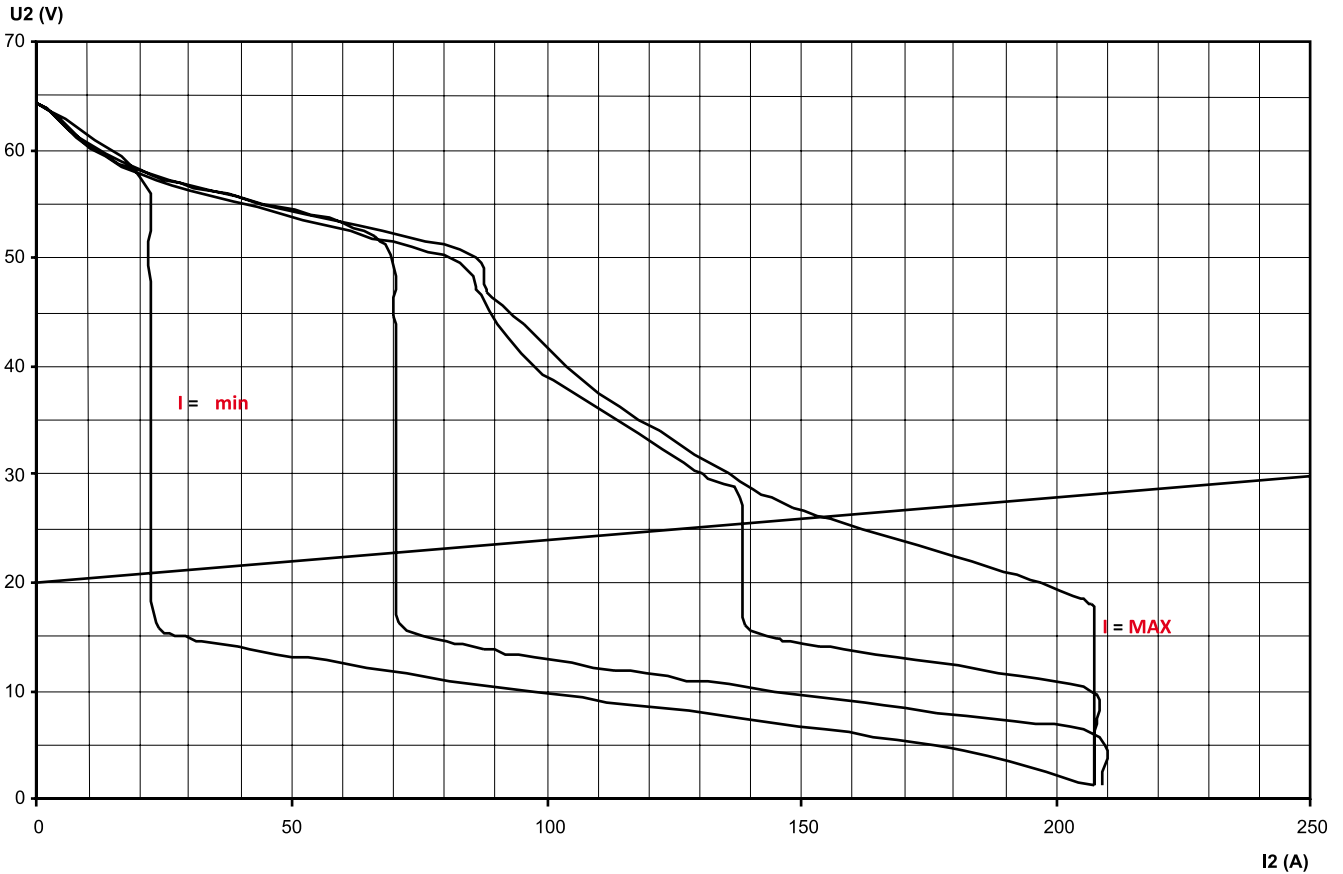

SIMULTANEOUS UTILIZATION FACTORS

In case **Welding** and **Generation** can be used simultaneously, however, the engine **cannot** be overloaded. The table below gives the maximum limits to be respected.

WELDING CURRENT	>150A	125A	100A	75A	50A	0A
POWER GENERATION 230 Vac	0 kVA	0.8 kVA	1.5 kVA	2.1 kVA	2.5 kVA	3 kVA
POWER GENERATION 115 Vac	0 kVA	0.5 kVA	1 kVA	1.3 kVA	1.5 kVA	1.8 kVA

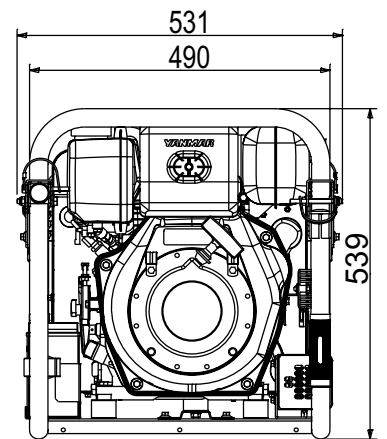
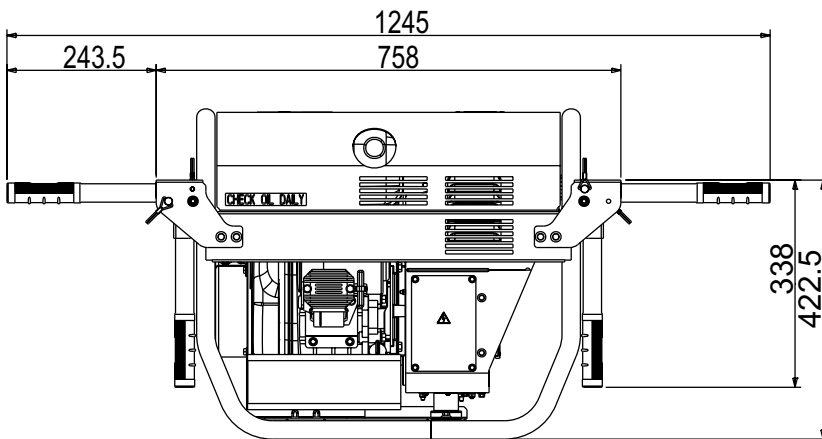
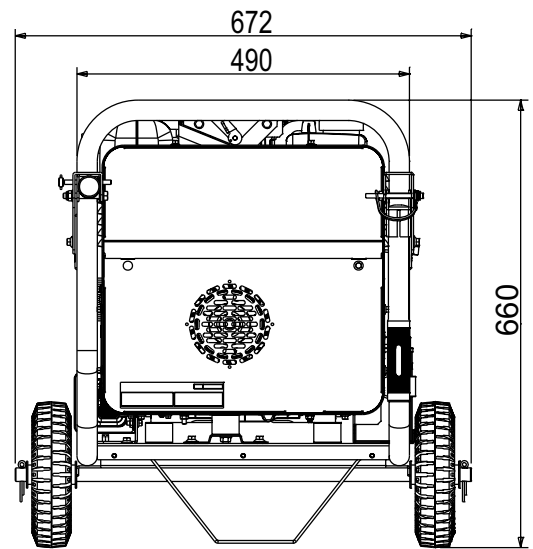
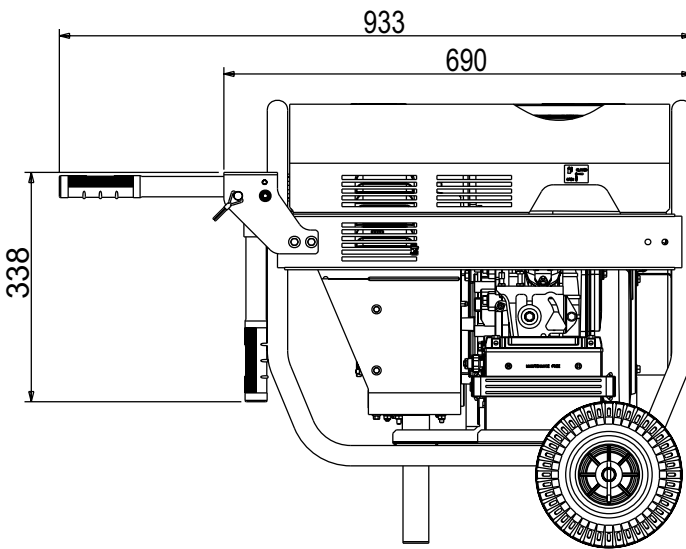
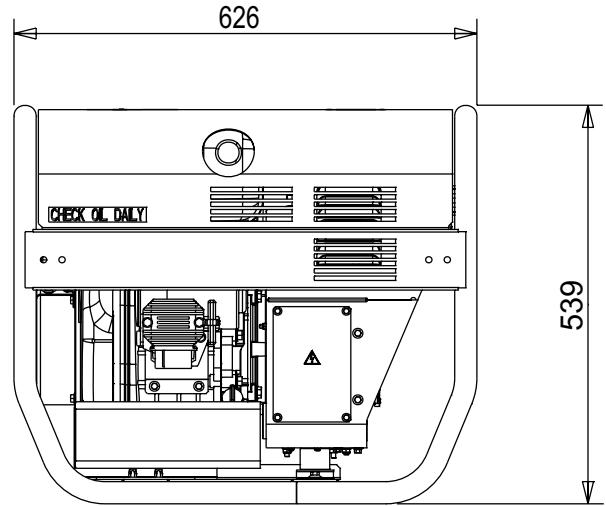
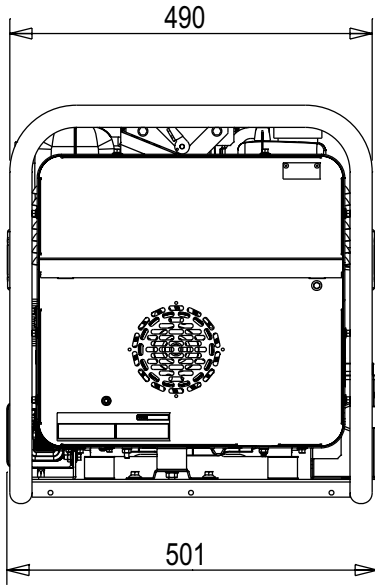



Lined area for notes with a dotted top line and horizontal lines below.



MOSA

MOSA div. della BCS S.p.A.

Viale Europa, 59 20090 Cusago (Milano) Italy

Tel. +39 - 0290352.1 Fax +39 - 0290390466 www.mosa.it

