

# ***powermax1650<sup>®</sup>***

## ***Plasma Arc Cutting & Gouging System***

***Operator Manual  
804480 Revision 3***

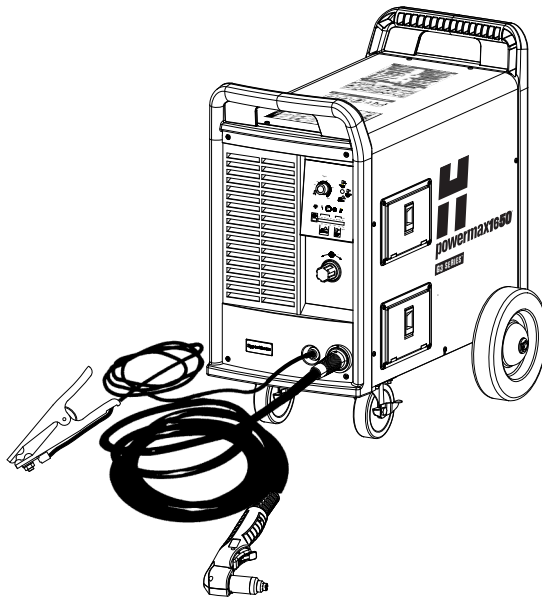

***Hypertherm<sup>®</sup>***

*The world leader in  
plasma cutting technology™*

## Register your new Hypertherm system

Register your product on-line at [www.hypertherm.com/registration](http://www.hypertherm.com/registration) for easier technical and warranty support. You can also receive updates on new Hypertherm products and a free gift as a token of our appreciation.

### For your records

Serial number: \_\_\_\_\_

Purchase date: \_\_\_\_\_

Distributor: \_\_\_\_\_

\_\_\_\_\_

\_\_\_\_\_

Maintenance notes:

\_\_\_\_\_

\_\_\_\_\_

\_\_\_\_\_

\_\_\_\_\_

\_\_\_\_\_

\_\_\_\_\_

***powermax1650***<sup>®</sup>

**Operator Manual**  
**(P/N 804480)**

**Revision 3 – September 2009**

**Hypertherm, Inc.**  
**Hanover, NH USA**  
**[www.hypertherm.com](http://www.hypertherm.com)**

© Copyright 2009 Hypertherm, Inc.  
All Rights Reserved

Hypertherm and powermax are trademarks of Hypertherm, Inc.  
and may be registered in the United States and/or other countries.

**Hypertherm, Inc.**

Etna Road, P.O. Box 5010  
Hanover, NH 03755 USA  
603-643-3441 Tel (Main Office)  
603-643-5352 Fax (All Departments)  
info@hypertherm.com (Main Office Email)  
**800-643-9878 Tel (Technical Service)**  
technical.service@hypertherm.com (Technical Service Email)  
800-737-2978 Tel (Customer Service)  
customer.service@hypertherm.com (Customer Service Email)

**Hypertherm Automation**

5 Technology Drive, Suite 300  
West Lebanon, NH 03784 USA  
603-298-7970 Tel  
603-298-7977 Fax

**Hypertherm Plasmatechnik GmbH**

Technologiepark Hanau  
Rodenbacher Chaussee 6  
D-63457 Hanau-Wolfgang, Deutschland  
49 6181 58 2100 Tel  
49 6181 58 2134 Fax  
**49 6181 58 2123 (Technical Service)**

**Hypertherm (S) Pte Ltd.**

82 Genting Lane  
Media Centre  
Annexe Block #A01-01  
Singapore 349567, Republic of Singapore  
65 6841 2489 Tel  
65 6841 2490 Fax  
**65 6841 2489 (Technical Service)**

**Hypertherm (Shanghai) Trading Co., Ltd.**

Unit A, 5th Floor, Careri Building  
432 West Huai Hai Road  
Shanghai, 200052  
PR China  
86-21 5258 3330/1 Tel  
86-21 5258 3332 Fax

**Hypertherm Europe B.V.**

Vaartveld 9  
4704 SE  
Roosendaal, Nederland  
31 165 596907 Tel  
31 165 596901 Fax  
31 165 596908 Tel (Marketing)  
**31 165 596900 Tel (Technical Service)**  
**00 800 4973 7843 Tel (Technical Service)**

**Hypertherm Japan Ltd.**

801 Samty Will Building  
2-40 Miyahara 1-Chome,  
Yodogawa-ku, Osaka  
532-0003, Japan  
81 6 6170 2020 Tel  
81 6 6170 2015 Fax

**Hypertherm Brasil Ltda.**

Avenida Doutor Renato de  
Andrade Maia 350  
Parque Renato Maia  
CEP 07114-000  
Guarulhos, SP Brasil  
55 11 2409 2636 Tel  
55 11 2408 0462 Fax

**Hypertherm México, S.A. de C.V.**

Avenida Toluca No. 444, Anexo 1,  
Colonia Olivar de los Padres  
Delegación Álvaro Obregón  
México, D.F. C.P. 01780  
52 55 5681 8109 Tel  
52 55 5683 2127 Fax

## EMC Introduction

Hypertherm's CE-marked equipment is built in compliance with standard EN60974-10. The equipment should be installed and used in accordance with the information below to achieve electromagnetic compatibility.

The limits required by EN60974-10 may not be adequate to completely eliminate interference when the affected equipment is in close proximity or has a high degree of sensitivity. In such cases it may be necessary to use other measures to further reduce interference.

This cutting equipment is designed for use only in an industrial environment.

## Installation and use

The user is responsible for installing and using the plasma equipment according to the manufacturer's instructions. If electromagnetic disturbances are detected then it shall be the responsibility of the user to resolve the situation with the technical assistance of the manufacturer. In some cases this remedial action may be as simple as earthing the cutting circuit, see *Earthing of Workpiece*. In other cases it could involve constructing an electromagnetic screen enclosing the power source and the work complete with associated input filters. In all cases electromagnetic disturbances must be reduced to the point where they are no longer troublesome.

## Assessment of area

Before installing the equipment the user shall make an assessment of potential electromagnetic problems in the surrounding area. The following shall be taken into account:

- a. Other supply cables, control cables, signalling and telephone cables; above, below and adjacent to the cutting equipment.

- b. Radio and television transmitters and receivers.
- c. Computer and other control equipment.
- d. Safety critical equipment, for example guarding of industrial equipment.
- e. Health of the people around, for example the use of pacemakers and hearing aids.
- f. Equipment used for calibration or measurement.
- g. Immunity of other equipment in the environment. User shall ensure that other equipment being used in the environment is compatible. This may require additional protection measures.
- h. Time of day that cutting or other activities are to be carried out.

The size of the surrounding area to be considered will depend on the structure of the building and other activities that are taking place. The surrounding area may extend beyond the boundaries of the premises.

## Methods of reducing emissions

### Mains supply

Cutting equipment must be connected to the mains supply according to the manufacturer's recommendations. If interference occurs, it may be necessary to take additional precautions such as filtering of the mains supply. Consideration should be given to shielding the supply cable of permanently installed cutting equipment, in metallic conduit or equivalent. Shielding should be electrically continuous throughout its length. The shielding should be connected to the cutting mains supply so that good electrical contact is maintained between the conduit and the cutting power source enclosure.

## **Maintenance of cutting equipment**

The cutting equipment must be routinely maintained according to the manufacturer's recommendations. All access and service doors and covers should be closed and properly fastened when the cutting equipment is in operation. The cutting equipment should not be modified in any way except for those changes and adjustments covered in the manufacturer's instructions. In particular, the spark gaps of arc striking and stabilizing devices should be adjusted and maintained according to the manufacturer's recommendations.

## **Cutting cables**

The cutting cables should be kept as short as possible and should be positioned close together, running at or close to the floor level.

## **Equipotential bonding**

Bonding of all metallic components in the cutting installation and adjacent to it should be considered. However, metallic components bonded to the workpiece will increase the risk that the operator could receive a shock by touching these metallic components and the electrode (nozzle for laser heads) at the same time. The operator should be insulated from all such bonded metallic components.

## **Earthing of workpiece**

Where the workpiece is not bonded to earth for electrical safety, nor connected to earth because of its size and position, for example, ship's hull or building steelwork, a connection bonding the workpiece to earth may reduce emissions in some, but not all instances. Care should be taken to prevent the earthing of the workpiece increasing the risk of injury to users, or damage to other electrical equipment. Where necessary, the connection of the

workpiece to earth should be made by a direct connection to the workpiece, but in some countries where direct connection is not permitted, the bonding should be achieved by suitable capacitances selected according to national regulations.

Note: the cutting circuit may or may not be earthed for safety reasons. Changing the earthing arrangements should only be authorized by a person who is competent to assess whether the changes will increase the risk of injury, for example, by allowing parallel cutting current return paths which may damage the earth circuits of other equipment. Further guidance is given in IEC/ TS 62081 Arc Welding Equipment Installation and Use.

## **Screening and shielding**

Selective screening and shielding of other cables and equipment in the surrounding area may alleviate problems of interference. Screening of the entire plasma cutting installation may be considered for special applications.

## Attention

Genuine Hypertherm parts are the factory-recommended replacement parts for your Hypertherm system. Any damage caused by the use of other than genuine Hypertherm parts may not be covered by the Hypertherm warranty.

You are responsible for the safe use of the Product. Hypertherm does not and cannot make any guarantee or warranty regarding the safe use of the Product in your environment.

## General

Hypertherm, Inc. warrants that its Products shall be free from defects in materials and workmanship, if Hypertherm is notified of a defect (i) with respect to the power supply within a period of two (2) years from the date of its delivery to you, with the exception of Powermax brand power supplies, which shall be within a period of three (3) years from the date of delivery to you, and (ii) with respect to the torch and leads within a period of one (1) year from its date of delivery to you, and with respect to torch lifter assemblies within a period of one (1) year from its date of delivery to you, and with respect to laser heads within a period of one (1) year from its date of delivery to you. This warranty shall not apply to any Powermax brand power supplies that have been used with phase converters. In addition, Hypertherm does not warranty systems that have been damaged as a result of poor power quality, whether from phase converters or incoming line power. This warranty shall not apply to any Product which has been incorrectly installed, modified, or otherwise damaged.

Hypertherm, at its sole option, shall repair, replace, or adjust, free of charge, any defective Products covered by this warranty which shall be returned with Hypertherm's prior authorization (which shall not be unreasonably withheld), properly packed, to Hypertherm's place of business in Hanover, New Hampshire, or to an authorized Hypertherm repair facility, all

costs, insurance and freight prepaid.

Hypertherm shall not be liable for any repairs, replacement, or adjustments of Products covered by this warranty, except those made pursuant to this paragraph or with Hypertherm's prior written consent. **The warranty above is exclusive and is in lieu of all other warranties, express, implied, statutory, or otherwise with respect to the Products or as to the results which may be obtained therefrom, and all implied warranties or conditions of quality or of merchantability or fitness for a particular purpose or against infringement. The foregoing shall constitute the sole and exclusive remedy for any breach by Hypertherm of its warranty.** Distributors/OEMs may offer different or additional warranties, but Distributors/OEMs are not authorized to give any additional warranty protection to you or make any representation to you purporting to be binding upon Hypertherm.

## Certification test marks

Certified products are identified by one or more certification test marks from accredited testing laboratories. The certification test marks are located on or near the data plate. Each certification test mark means that the product and its safety-critical components conform to the relevant national safety standards as reviewed by that testing laboratory. Hypertherm places a certification test mark on its products only after that product is manufactured with safety-critical components that have been authorized by the accredited testing laboratory.

Once the product has left the Hypertherm factory, the certification test marks are invalidated if any of the following occurs:

- The product is significantly modified in a manner that creates a hazard or non-conformance.
- Safety-critical components are replaced with unauthorized spare parts.

- Any unauthorized assembly or accessory that uses or generates a hazardous voltage is added.
- There is any tampering with a safety circuit or other feature that is designed into the product as part of the certification.

CE marking constitutes a manufacturer's declaration of conformity to applicable European directives and standards. Only those versions of Hypertherm products with a CE Marking located on or near the data plate have been tested for compliance with the European Low Voltage Directive and the European EMC Directive. EMC filters needed to comply with the European EMC Directive are incorporated within versions of the power supply with a CE Marking.

### Differences in National Standards

Differences in standards include, but are not limited to:

- Voltages
- Plug and cord ratings
- Language requirements
- Electromagnetic compatibility requirements

These differences in national standards may make it impossible or impractical for all certification test marks to be placed on the same version of a product. For example, the CSA versions of Hypertherm's products do not comply with European EMC requirements and they do not have a CE marking on the data plate.

Countries that require CE marking or have compulsory EMC regulations must use CE versions of Hypertherm products with the CE marking on the data plate. These include:

- Australia
- New Zealand
- Countries in the European Union
- Russia

It is important that the product and its certification test mark be suitable for the end-use installation site. When Hypertherm products are shipped to one country for export to another country, the product must be configured and certified properly for the end-use site.

### Higher-level systems

When a system integrator adds additional equipment; such as cutting tables, motor drives, motion controllers or robots; to a Hypertherm plasma cutting system, the combined system may be considered a higher-level system. A higher-level system with hazardous moving parts may constitute industrial machinery or robotic equipment, in which case the OEM or end-use customer may be subject to additional regulations and standards than those relevant to the plasma cutting system as manufactured by Hypertherm.

It is the responsibility of the end-use customer and the OEM to perform a risk assessment for the higher-level system and to provide protection against hazardous moving parts. Unless the higher-level system is certified when the OEM incorporates Hypertherm products into it, the installation also may be subject to approval by local authorities. Seek advice from legal counsel and local regulatory experts if uncertain about compliance.

External interconnecting cables between component parts of the higher level system must be suitable for contaminants and movement as required by the final end-use installation site. When the external interconnecting cables are subject to oil, dust, or water contaminants, hard usage ratings may be required. When external interconnecting cables are subject to continuous movement, constant flexing ratings may be required. It is the responsibility of the end-use customer or the OEM to ensure the cables are suitable for the application. Since there are differences in the



ratings and costs that can be required by local regulations for higher-level systems, it is necessary to verify that any external interconnecting cables are suitable for the end-use installation site.

## **Patent indemnity**

Except only in cases of products not manufactured by Hypertherm or manufactured by a person other than Hypertherm not in strict conformity with Hypertherm's specifications and in cases of designs, processes, formulae, or combinations not developed or purported to be developed by Hypertherm, Hypertherm will defend or settle, at its own expense, any suit or proceeding brought against you alleging that the use of the Hypertherm product, alone and not in combination with any other product not supplied by Hypertherm, infringes any patent of any third party. You shall notify Hypertherm promptly upon learning of any action or threatened action in connection with any such alleged infringement, and Hypertherm's obligation to indemnify shall be conditioned upon Hypertherm's sole control of, and the indemnified party's cooperation and assistance in, the defense of the claim.

## **Limitation of liability**

**In no event shall Hypertherm be liable to any person or entity for any incidental, consequential, indirect, or punitive damages (including but not limited to lost profits) regardless of whether such liability is based on breach of contract, tort, strict liability, breach of warranties, failure of essential purpose or otherwise and even if advised of the possibility of such damages.**

## **Liability cap**

**In no event shall Hypertherm's liability, whether such liability is based on breach of contract, tort, strict liability, breach of warranties, failure of essential purpose or otherwise, for any claim action suit or proceeding arising out of or relating to the**

**use of the Products exceed in the aggregate the amount paid for the Products that gave rise to such claim.**

## **Insurance**

At all times you will have and maintain insurance in such quantities and types, and with coverage sufficient and appropriate to defend and to hold Hypertherm harmless in the event of any cause of action arising from the use of the Products.

## **National and Local codes**

National and Local codes governing plumbing and electrical installation shall take precedent over any instructions contained in this manual.

**In no event** shall Hypertherm be liable for injury to persons or property damage by reason of any code violation or poor work practices.

## **Transfer of rights**

You may transfer any remaining rights you may have hereunder only in connection with the sale of all or substantially all of your assets or capital stock to a successor in interest who agrees to be bound by all of the terms and conditions of this Warranty.

## **Proper disposal of Hypertherm products**

Hypertherm plasma cutting systems, like all electronic products, may contain materials or components, such as printed circuit boards, that cannot be discarded with ordinary waste. It is your responsibility to dispose of any Hypertherm product or component part in an environmentally acceptable manner according to national and local codes.

- In the United States, check all federal, state, and local laws.
- In the European Union, check the EU directives, national, and local laws. For more information, visit [www.hypertherm.com/weee](http://www.hypertherm.com/weee).
- In other countries, check national and local laws.



Electromagnetic compatibility.....i  
 Warranty.....iii

**Section 1 Safety**

Recognize safety information .....1-2  
 Follow safety instructions .....1-2  
 Cutting can cause fire or explosion .....1-2  
 Electric shock can kill .....1-3  
 Static electricity can damage circuit boards .....1-3  
 Toxic fumes can cause injury or death.....1-4  
 A plasma arc can cause injury and burns.....1-5  
 Arc rays can burn eyes and skin.....1-5  
 Grounding safety.....1-6  
 Compressed gas equipment safety .....1-6  
 Gas cylinders can explode if damaged .....1-6  
 Noise can damage hearing .....1-7  
 Pacemaker and hearing aid operation .....1-7  
 A plasma arc can damage frozen pipes.....1-7  
 Additional safety information .....1-8  
 Warning labels.....1-9  
 Dust collection information.....1-11

**Section 1a Sécurité**

Identifier les consignes de sécurité .....1a-2  
 Suivre les instructions de sécurité .....1a-2  
 Le coupage peut provoquer un incendie ou une explosion .....1a-2  
 Les chocs électriques peuvent être fatals .....1a-3  
 L'électricité statique peut endommager les cartes de circuits imprimés .....1a-3  
 Les vapeurs toxiques peuvent provoquer des blessures ou la mort .....1a-4  
 L'arc plasma peut provoquer des blessures ou des brûlures .....1a-5  
 Les rayons de l'arc peuvent brûler les yeux et la peau .....1a-5  
 Mise à la masse et à la terre.....1a-6  
 Sécurité des bouteilles de gaz comprimé .....1a-6  
 Les bouteilles de gaz comprimé peuvent exploser en cas de dommages .....1a-6  
 Le bruit peut provoquer des problèmes auditifs .....1a-7  
 Pacemakers et prothèses auditives .....1a-7  
 Un arc plasma peut endommager les tuyaux gelés.....1a-7  
 Symboles et marquage.....1a-8  
 Étiquette de sécurité .....1a-9  
 Information sur le dépoussiérage .....1a-11

**Section 1b Seguridad**

Reconocimiento de información de seguridad .....1b-2  
 Siga las instrucciones de seguridad .....1b-2  
 Los cortes pueden provocar incendios o explosiones .....1b-2

# TABLE OF CONTENTS

---

El choque eléctrico puede provocar la muerte.....1b-3  
Electricidad estática puede dañar tablillas de circuito .....1b-3  
Humos tóxicos pueden causar lesiones o muerte.....1b-4  
El arco de plasma puede causar lesiones y quemaduras.....1b-5  
Los rayos del arco pueden producir quemaduras en los ojos y en la piel .....1b-5  
Seguridad de toma a tierra.....1b-6  
Seguridad de los equipos de gas comprimido.....1b-6  
Los cilindros de gas pueden explotar si están dañados .....1b-6  
El ruido puede deteriorar la audición .....1b-7  
Operación de marcapasos y de audífonos.....1b-7  
Un arco plasma puede dañar tubos congelados .....1b-7  
Símbolos y marcas .....1b-8  
Etiquetas de advertencia .....1b-9  
Información sobre la colección de polvo seco.....1b-11

## Section 2 Specifications

Power supply .....2-2  
    Duty cycle.....2-3  
    Dimensions and weight.....2-3  
T100 torches .....2-4  
    Torch dimensions.....2-5  
Symbols and markings.....2-6  
    [S] mark.....2-6  
    CE mark .....2-6  
    IEC symbols used .....2-6

## Section 3 Setup

Upon receipt.....3-2  
Claims .....3-2  
Contents of box .....3-2  
Lifting the power supply .....3-3  
Locating power supply.....3-4  
Power connection .....3-4  
    Engine drives .....3-5  
Grounding .....3-6  
Power cords .....3-6  
Three-phase power cord – plug installation.....3-7  
    Power cord installation .....3-7  
    Plug installation .....3-7  
Torch installation.....3-8  
Plasma gas supply .....3-10  
    Additional gas filtration .....3-10  
Gas supply installation .....3-11  
T100M-2 torch alignment.....3-11

ON/OFF pendant connection .....3-12  
 Machine interface connection .....3-12  
 Arc voltage.....3-13  
 Changing XFER (start machine motion) from dry contact closure to voltage signal.....3-15

**Section 4 Operation**

Controls and indicators .....4-2  
 Indicator LEDs.....4-2  
 Install the consumables .....4-3  
 T100 consumable configurations.....4-4  
 Shielded.....4-4  
 Unshielded .....4-4  
 FineCut.....4-4  
 Gouging .....4-5  
 T100M-2 consumable configurations .....4-5  
 Shielded.....4-5  
 FineCut.....4-6  
 Ohmic sensing retaining cap .....4-6  
 Unshielded .....4-6  
 Set the mode switch.....4-7  
 Turn ON the power .....4-7  
 Check the indicator lights.....4-7  
 Adjust the gas pressure and current setting .....4-8  
 Hand torch operation .....4-9  
 Safety trigger operation .....4-9  
 Attach the work clamp .....4-10  
 Start a cut from the edge of the workpiece .....4-10  
 Hand torch cutting technique.....4-11  
 Piercing .....4-12  
 Gouging .....4-13  
 Cut charts.....4-14

**Section 5 Maintenance and parts**

Routine maintenance.....5-2  
 Inspect the consumables.....5-3  
 Filter element replacement .....5-4  
 Controls and indicators .....5-5  
 Basic troubleshooting.....5-6  
 System circuit diagram .....5-9  
 Technical questions.....5-10  
 Parts.....5-10  
 Torch parts.....5-10  
 Power supply parts.....5-11  
 Accessories.....5-11

## TABLE OF CONTENTS

---

# Section 1

## SAFETY

---

*In this section:*

Recognize safety information .....	1-2
Follow safety instructions .....	1-2
Cutting can cause fire or explosion .....	1-2
Electric shock can kill .....	1-3
Static electricity can damage circuit boards .....	1-3
Toxic fumes can cause injury or death.....	1-4
A plasma arc can cause injury and burns.....	1-5
Arc rays can burn eyes and skin.....	1-5
Grounding safety.....	1-6
Compressed gas equipment safety.....	1-6
Gas cylinders can explode if damaged.....	1-6
Noise can damage hearing .....	1-7
Pacemaker and hearing aid operation .....	1-7
A plasma arc can damage frozen pipes.....	1-7
Additional safety information.....	1-7
Symbols and markings.....	1-8
Warning labels.....	1-9
Dry dust collection information.....	1-11



## RECOGNIZE SAFETY INFORMATION

The symbols shown in this section are used to identify potential hazards. When you see a safety symbol in this manual or on your machine, understand the potential for personal injury, and follow the related instructions to avoid the hazard.



## FOLLOW SAFETY INSTRUCTIONS

Read carefully all safety messages in this manual and safety labels on your machine.

- Keep the safety labels on your machine in good condition. Replace missing or damaged labels immediately.
- Learn how to operate the machine and how to use the controls properly. Do not let anyone operate it without instruction.
- Keep your machine in proper working condition. Unauthorized modifications to the machine may affect safety and machine service life.

## DANGER WARNING CAUTION

Hypertherm uses American National Standards Institute guidelines for safety signal words and symbols. A signal word DANGER or WARNING is used with a safety symbol. DANGER identifies the most serious hazards.

- DANGER and WARNING safety labels are located on your machine near specific hazards.
- DANGER safety messages precede related instructions in the manual that will result in serious injury or death if not followed correctly.
- WARNING safety messages precede related instructions in this manual that may result in injury or death if not followed correctly.
- CAUTION safety messages precede related instructions in this manual that may result in minor injury or damage to equipment if not followed correctly.



## CUTTING CAN CAUSE FIRE OR EXPLOSION

### Fire Prevention

- Be sure the area is safe before doing any cutting. Keep a fire extinguisher nearby.
- Remove all flammables within 35 feet (10 m) of the cutting area.
- Quench hot metal or allow it to cool before handling or before letting it touch combustible materials.
- Never cut containers with potentially flammable materials inside – they must be emptied and properly cleaned first.
- Ventilate potentially flammable atmospheres before cutting.
- When cutting with oxygen as the plasma gas, an exhaust ventilation system is required.

### Explosion Prevention

- Do not use the plasma system if explosive dust or vapors may be present.
- Do not cut pressurized cylinders, pipes, or any closed container.
- Do not cut containers that have held combustible materials.



### WARNING

Explosion Hazard  
Argon-Hydrogen and Methane

Hydrogen and methane are flammable gases that present an explosion hazard. Keep flames away from cylinders and hoses that contain methane or hydrogen mixtures. Keep flames and sparks away from the torch when using methane or argon-hydrogen plasma.



### WARNING

Hydrogen Detonation with  
Aluminum Cutting

- When cutting aluminum underwater, or with the water touching the underside of the aluminum, free hydrogen gas may collect under the workpiece and detonate during plasma cutting operations.
- Install an aeration manifold on the floor of the water table to eliminate the possibility of hydrogen detonation. Refer to the Appendix section of this manual for aeration manifold details.





## ELECTRIC SHOCK CAN KILL

Touching live electrical parts can cause a fatal shock or severe burn.

- Operating the plasma system completes an electrical circuit between the torch and the workpiece. The workpiece and anything touching the workpiece are part of the electrical circuit.
- Never touch the torch body, workpiece or the water in a water table when the plasma system is operating.

### Electric Shock Prevention

**All Hypertherm plasma systems use high voltage in the cutting process (200 to 400 VDC are common). Take the following precautions when operating this system:**

- Wear insulated gloves and boots, and keep your body and clothing dry.
- Do not stand, sit or lie on – or touch – any wet surface when using the plasma system.
- Insulate yourself from work and ground using dry insulating mats or covers big enough to prevent any physical contact with the work or ground. If you must work in or near a damp area, use extreme caution.
- Provide a disconnect switch close to the power supply with properly sized fuses. This switch allows the operator to turn off the power supply quickly in an emergency situation.
- When using a water table, be sure that it is correctly connected to earth ground.

- Install and ground this equipment according to the instruction manual and in accordance with national and local codes.
- Inspect the input power cord frequently for damage or cracking of the cover. Replace a damaged power cord immediately. **Bare wiring can kill.**
- Inspect and replace any worn or damaged torch leads.
- Do not pick up the workpiece, including the waste cutoff, while you cut. Leave the workpiece in place or on the workbench with the work cable attached during the cutting process.
- Before checking, cleaning or changing torch parts, disconnect the main power or unplug the power supply.
- Never bypass or shortcut the safety interlocks.
- Before removing any power supply or system enclosure cover, disconnect electrical input power. Wait 5 minutes after disconnecting the main power to allow capacitors to discharge.
- Never operate the plasma system unless the power supply covers are in place. Exposed power supply connections present a severe electrical hazard.
- When making input connections, attach proper grounding conductor first.
- Each Hypertherm plasma system is designed to be used only with specific Hypertherm torches. Do not substitute other torches which could overheat and present a safety hazard.



## STATIC ELECTRICITY CAN DAMAGE CIRCUIT BOARDS

Use proper precautions when handling printed circuit boards.

- Store PC boards in anti-static containers.
- Wear a grounded wrist strap when handling PC boards.



## TOXIC FUMES CAN CAUSE INJURY OR DEATH

The plasma arc by itself is the heat source used for cutting. Accordingly, although the plasma arc has not been identified as a source of toxic fumes, the material being cut can be a source of toxic fumes or gases that deplete oxygen.

Fumes produced vary depending on the metal that is cut. Metals that may release toxic fumes include, but are not limited to, stainless steel, carbon steel, zinc (galvanized), and copper.

In some cases, the metal may be coated with a substance that could release toxic fumes. Toxic coatings include, but are not limited to, lead (in some paints), cadmium (in some paints and fillers), and beryllium.

Gases produced by plasma cutting vary based on the material to be cut and the method of cutting, but may include ozone, oxides of nitrogen, hexavalent chromium, hydrogen, and other substances if such are contained in or released by the material being cut.

Caution should be taken to minimize exposure to fumes produced by any industrial process. Depending upon the chemical composition and concentration of the fumes (as well as other factors, such as ventilation), there may be a risk of physical illness, such as birth defects or cancer.

It is the responsibility of the equipment and site owner to test the air quality in the area where the equipment is used and to ensure that the air quality in the workplace meets all local and national standards and regulations.

The air quality level in any relevant workplace depends on site-specific variables such as:

- Table design (wet, dry, underwater).
- Material composition, surface finish, and composition of coatings.
- Volume of material removed.

- Duration of cutting or gouging.
- Size, air volume, ventilation and filtration of the work area.
- Personal protective equipment.
- Number of welding and cutting systems in operation.
- Other site processes that may produce fumes.

If the workplace must conform to national or local regulations, only monitoring or testing done at the site can determine whether the site is above or below allowable levels.

To reduce the risk of exposure to fumes:

- Remove all coatings and solvents from the metal before cutting.
- Use local exhaust ventilation to remove fumes from the air.
- Do not inhale fumes. Wear an air-supplied respirator when cutting any metal coated with, containing, or suspected to contain toxic elements.
- Assure that those using welding or cutting equipment, as well as air-supplied respiration devices, are qualified and trained in the proper use of such equipment.
- Never cut containers with potentially toxic materials inside. Empty and properly clean the container first.
- Monitor or test the air quality at the site as needed.
- Consult with a local expert to implement a site plan to ensure safe air quality.



## A PLASMA ARC CAN CAUSE INJURY AND BURNS

### Instant-On Torches

Plasma arc comes on immediately when the torch switch is activated.

The plasma arc will cut quickly through gloves and skin.

- Keep away from the torch tip.
- Do not hold metal near the cutting path.
- Never point the torch toward yourself or others.



## ARC RAYS CAN BURN EYES AND SKIN

**Eye Protection** Plasma arc rays produce intense visible and invisible (ultraviolet and infrared) rays that can burn eyes and skin.

- Use eye protection in accordance with applicable national or local codes.
- Wear eye protection (safety glasses or goggles with side shields, and a welding helmet) with appropriate lens shading to protect your eyes from the arc's ultraviolet and infrared rays.

**Skin Protection** Wear protective clothing to protect against burns caused by ultraviolet light, sparks and hot metal.

- Gauntlet gloves, safety shoes and hat.
- Flame-retardant clothing to cover all exposed areas.
- Cuffless trousers to prevent entry of sparks and slag.
- Remove any combustibles, such as a butane lighter or matches, from your pockets before cutting.

**Cutting Area** Prepare the cutting area to reduce reflection and transmission of ultraviolet light:

- Paint walls and other surfaces with dark colors to reduce reflection.
- Use protective screens or barriers to protect others from flash and glare.
- Warn others not to watch the arc. Use placards or signs.

Arc current (amps)	Minimum protective shade number (ANSI Z49.1:2005)	Suggested shade number for comfort (ANSI Z49.1:2005)	OSHA 29CFR 1910.133(a)(5)	Europe EN168:2002
Less than 40 A	5	5	8	9
41 to 60 A	6	6	8	9
61 to 80 A	8	8	8	9
81 to 125 A	8	9	8	9
126 to 150 A	8	9	8	10
151 to 175 A	8	9	8	11
176 to 250 A	8	9	8	12
251 to 300 A	8	9	8	13
301 to 400 A	9	12	9	13
401 to 800 A	10	14	10	



## GROUNDING SAFETY

**Work Cable** Attach the work cable securely to the workpiece or the work table with good metal-to-metal contact. Do not connect it to the piece that will fall away when the cut is complete.

**Work Table** Connect the work table to an earth ground, in accordance with appropriate national or local electrical codes.

## Input Power

- Be sure to connect the power cord ground wire to the ground in the disconnect box.
- If installation of the plasma system involves connecting the power cord to the power supply, be sure to connect the power cord ground wire properly.
- Place the power cord's ground wire on the stud first, then place any other ground wires on top of the power cord ground. Fasten the retaining nut tightly.
- Tighten all electrical connections to avoid excessive heating.

## COMPRESSED GAS EQUIPMENT SAFETY

- Never lubricate cylinder valves or regulators with oil or grease.
- Use only correct gas cylinders, regulators, hoses and fittings designed for the specific application.
- Maintain all compressed gas equipment and associated parts in good condition.
- Label and color-code all gas hoses to identify the type of gas in each hose. Consult applicable national or local codes.



## GAS CYLINDERS CAN EXPLODE IF DAMAGED

Gas cylinders contain gas under high pressure. If damaged, a cylinder can explode.

- Handle and use compressed gas cylinders in accordance with applicable national or local codes.
- Never use a cylinder that is not upright and secured in place.
- Keep the protective cap in place over valve except when the cylinder is in use or connected for use.
- Never allow electrical contact between the plasma arc and a cylinder.
- Never expose cylinders to excessive heat, sparks, slag or open flame.
- Never use a hammer, wrench or other tool to open a stuck cylinder valve.



## NOISE CAN DAMAGE HEARING

Prolonged exposure to noise from cutting or gouging can damage hearing.

- Use approved ear protection when using plasma system.
- Warn others nearby about the noise hazard.



## A PLASMA ARC CAN DAMAGE FROZEN PIPES

Frozen pipes may be damaged or can burst if you attempt to thaw them with a plasma torch.



## PACEMAKER AND HEARING AID OPERATION

Pacemaker and hearing aid operation can be affected by magnetic fields from high currents.

Pacemaker and hearing aid wearers should consult a doctor before going near any plasma arc cutting and gouging operations.

To reduce magnetic field hazards:

- Keep both the work cable and the torch lead to one side, away from your body.
- Route the torch leads as close as possible to the work cable.
- Do not wrap or drape the torch lead or work cable around your body.
- Keep as far away from the power supply as possible.

## ADDITIONAL SAFETY INFORMATION

1. ANSI Standard Z49.1, *Safety in Welding and Cutting*, American Welding Society, 550 LeJeune Road, P.O. Box 351020, Miami, FL 33135
2. ANSI Standard Z49.2, *Fire Prevention in the Use of Cutting and Welding Processes*, American National Standards Institute, 1430 Broadway, New York, NY 10018
3. ANSI Standard Z87.1, *Safe Practices for Occupation and Educational Eye and Face Protection*, American National Standards Institute, 1430 Broadway, New York, NY 10018
4. AWS F4.1, *Recommended Safe Practices for the Preparation for Welding and Cutting of Containers and Piping That Have Held Hazardous Substances*, American Welding Society, 550 LeJeune Road, P.O. Box 351040, Miami, FL 33135
5. AWS F5.2, *Recommended Safe Practices for Plasma Arc Cutting*, American Welding Society, 550 LeJeune Road, P.O. Box 351040, Miami, FL 33135
6. CGA Pamphlet P-1, *Safe Handling of Compressed Gases in Cylinders*, Compressed Gas Association, 1235 Jefferson Davis Highway, Arlington, VA 22202
7. CSA Standard W117.2, *Code for Safety in Welding and Cutting*, Canadian Standards Association Standard Sales, 178 Rexdale Boulevard, Rexdale, Ontario M9W 1R3, Canada
8. NFPA Standard 51B, *Cutting and Welding Processes*, National Fire Protection Association, 470 Atlantic Avenue, Boston, MA 02210
9. NFPA Standard 70-1978, *National Electrical Code*, National Fire Protection Association, 470 Atlantic Avenue, Boston, MA 02210
10. OSHA, *Safety and Health Standards*, 29FR 1910 U.S. Government Printing Office, Washington, D.C. 20402
11. AWS Safety and Health Fact Sheets, American Welding Society 550 LeJeune Road, P.O. Box 351040, Miami, FL 33135  
[www.aws.org/technical/facts/](http://www.aws.org/technical/facts/)

## SYMBOLS AND MARKINGS

Your Hypertherm product may have one or more of the following markings on or near the data plate. Due to differences and conflicts in national regulations, not all marks are applied to every version of a product.



### S mark symbol

The S mark symbol indicates that the power supply and torch are suitable for operations carried out in environments with increased hazard of electrical shock per IEC 60974-1.



### CSA mark

Hypertherm products with a CSA mark meet the United States and Canadian regulations for product safety. The products were evaluated, tested, and certified by CSA-International. Alternatively the product may have a mark by one of the other Nationally Recognized Testing Laboratories (NRTL) accredited in both the United States and Canada, such as Underwriters Laboratories, Incorporated (UL) or TÜV.



### CE marking

The CE marking signifies the manufacturer's declaration of conformity to applicable European directives and standards. Only those versions of Hypertherm products with a CE marking located on or near the data plate have been tested for compliance with the European Low Voltage Directive and the European Electromagnetic Compatibility (EMC) Directive. EMC filters needed to comply with the European EMC Directive are incorporated within versions of the product with a CE marking.



### GOST-R mark

CE versions of Hypertherm products that include a GOST-R mark of conformity meet the product safety and EMC requirements for export to the Russian Federation.



### c-Tick mark

CE versions of Hypertherm products with a c-Tick mark comply with the EMC regulations required for sale in Australia and New Zealand.













### CCC mark

The China Compulsory Certification (CCC) mark indicates that the product has been tested and found compliant with product safety regulations required for sale in China.

## WARNING LABEL

This warning label is affixed to some power supplies. It is important that the operator and maintenance technician understand the intent of these warning symbols as described. The numbered text corresponds to the numbered boxes on the label.

		WARNING		AVERTISSEMENT	
					
Read and follow these instructions, employer safety practices, and material safety data sheets. Refer to ANS Z49.1, "Safety in Welding, Cutting and Allied Processes" from American Welding Society ( <a href="http://www.aws.org">http://www.aws.org</a> ) and OSHA Safety and Health Standards, 29 CFR 1910 ( <a href="http://www.osha.gov">http://www.osha.gov</a> ).		Plasma cutting can be injurious to operator and persons in the work area. Consult manual before operating. Failure to follow all these safety instructions can result in death.		Le coupage plasma peut être préjudiciable pour l'opérateur et les personnes qui se trouvent sur les lieux de travail. Consulter le manuel avant de faire fonctionner. Le non respect des ces instructions de sécurité peut entraîner la mort.	
		<b>1. Cutting sparks can cause explosion or fire.</b> 1.1 Do not cut near flammables. 1.2 Have a fire extinguisher nearby and ready to use. 1.3 Do not use a drum or other closed container as a cutting table.		<b>1. Les étincelles de coupage peuvent provoquer une explosion ou un incendie.</b> 1.1 Ne pas couper près des matières inflammables. 1.2 Un extincteur doit être à proximité et prêt à être utilisé. 1.3 Ne pas utiliser un fût ou un autre contenant fermé comme table de coupage.	
		<b>2. Plasma arc can injure and burn; point the nozzle away from yourself. Arc starts instantly when triggered.</b> 2.1 Turn off power before disassembling torch. 2.2 Do not grip the workpiece near the cutting path. 2.3 Wear complete body protection.		<b>2. L'arc plasma peut blesser et brûler; éloigner la buse de soi. Il s'allume instantanément quand on l'amorce;</b> 2.1 Couper l'alimentation avant de démonter la torche. 2.2 Ne pas saisir la pièce à couper de la trajectoire de coupage. 2.3 Se protéger entièrement le corps.	
		<b>3. Hazardous voltage. Risk of electric shock or burn.</b> 3.1 Wear insulating gloves. Replace gloves when wet or damaged. 3.2 Protect from shock by insulating yourself from work and ground. 3.3 Disconnect power before servicing. Do not touch live parts.		<b>3. Tension dangereuse. Risque de choc électrique ou de brûlure.</b> 3.1 Porter des gants isolants. Remplacer les gants quand ils sont humides ou endommagés. 3.2 Se protéger contre les chocs en s'isolant de la pièce et de la terre. 3.3 Couper l'alimentation avant l'entretien. Ne pas toucher les pièces sous tension.	
		<b>4. Plasma fumes can be hazardous.</b> 4.1 Do not inhale fumes. 4.2 Use forced ventilation or local exhaust to remove the fumes. 4.3 Do not operate in closed spaces. Remove fumes with ventilation.		<b>4. Les fumées plasma peuvent être dangereuses.</b> 4.1 Ne pas inhaler les fumées 4.2 Utiliser une ventilation forcée ou un extracteur local pour dissiper les fumées. 4.3 Ne pas couper dans des espaces clos. Chasser les fumées par ventilation.	
		<b>5. Arc rays can burn eyes and injure skin.</b> 5.1 Wear correct and appropriate protective equipment to protect head, eyes, ears, hands, and body. Button shirt collar. Protect ears from noise. Use welding helmet with the correct shade of filter.		<b>5. Les rayons d'arc peuvent brûler les yeux et blesser la peau.</b> 5.1 Porter un bon équipement de protection pour se protéger la tête, les yeux, les oreilles, les mains et le corps. Boutonner le col de la chemise. Protéger les oreilles contre le bruit. Utiliser un masque de soudeur avec un filtre de nuance appropriée.	
		<b>6. Become trained.</b> Only qualified personnel should operate this equipment. Use torches specified in the manual. Keep non-qualified personnel and children away.		<b>6. Suivre une formation.</b> Seul le personnel qualifié a le droit de faire fonctionner cet équipement. Utiliser exclusivement les torches indiquées dans le manuel. Le personnel non qualifié et les enfants doivent se tenir à l'écart.	
		<b>7. Do not remove, destroy, or cover this label.</b> Replace if it is missing, damaged, or worn (PN 110584 Rev C).		<b>7. Ne pas enlever, détruire ni couvrir cette étiquette.</b> La remplacer si elle est absente, endommagée ou usée (PN 110584 Rev C).	

1. Cutting sparks can cause explosion or fire.
  - 1.1 Do not cut near flammables.
  - 1.2 Have a fire extinguisher nearby and ready to use.
  - 1.3 Do not use a drum or other closed container as a cutting table.
2. Plasma arc can injure and burn; point the nozzle away from yourself. Arc starts instantly when triggered.
  - 2.1 Turn off power before disassembling torch.
  - 2.2 Do not grip the workpiece near the cutting path.
  - 2.3 Wear complete body protection.
3. Hazardous voltage. Risk of electric shock or burn.
  - 3.1 Wear insulating gloves. Replace gloves when wet or damaged.
  - 3.2 Protect from shock by insulating yourself from work and ground.
  - 3.3 Disconnect power before servicing. Do not touch live parts.
4. Plasma fumes can be hazardous.
  - 4.1 Do not inhale fumes.
  - 4.2 Use forced ventilation or local exhaust to remove the fumes.
  - 4.3 Do not operate in closed spaces. Remove fumes with ventilation.
5. Arc rays can burn eyes and injure skin.
  - 5.1 Wear correct and appropriate protective equipment to protect head, eyes, ears, hands, and body. Button shirt collar. Protect ears from noise. Use welding helmet with the correct shade of filter.
6. Become trained. Only qualified personnel should operate this equipment. Use torches specified in the manual. Keep non-qualified personnel and children away.
7. Do not remove, destroy, or cover this label. Replace if it is missing, damaged, or worn.

## WARNING LABEL

This warning label is affixed to some power supplies. It is important that the operator and maintenance technician understand the intent of these warning symbols as described. The numbered text corresponds to the numbered boxes on the label.



1. Cutting sparks can cause explosion or fire.
  - 1.1 Do not cut near flammables.
  - 1.2 Have a fire extinguisher nearby and ready to use.
  - 1.3 Do not use a drum or other closed container as a cutting table.
2. Plasma arc can injure and burn; point the nozzle away from yourself. Arc starts instantly when triggered.
  - 2.1 Turn off power before disassembling torch.
  - 2.2 Do not grip the workpiece near the cutting path.
  - 2.3 Wear complete body protection.
3. Hazardous voltage. Risk of electric shock or burn.
  - 3.1 Wear insulating gloves. Replace gloves when wet or damaged.
  - 3.2 Protect from shock by insulating yourself from work and ground.
  - 3.3 Disconnect power before servicing. Do not touch live parts.
4. Plasma fumes can be hazardous.
  - 4.1 Do not inhale fumes.
  - 4.2 Use forced ventilation or local exhaust to remove the fumes.
  - 4.3 Do not operate in closed spaces. Remove fumes with ventilation.
5. Arc rays can burn eyes and injure skin.
  - 5.1 Wear correct and appropriate protective equipment to protect head, eyes, ears, hands, and body. Button shirt collar. Protect ears from noise. Use welding helmet with the correct shade of filter.
6. Become trained. Only qualified personnel should operate this equipment. Use torches specified in the manual. Keep non-qualified personnel and children away.
7. Do not remove, destroy, or cover this label. Replace if it is missing, damaged, or worn.



## **DRY DUST COLLECTION INFORMATION**

At some sites, dry dust can represent a potential explosion hazard.

The U.S. National Fire Protection Association's 2007 edition of NFPA standard 68, "Explosion Protection by Deflagration Venting," provides requirements for the design, location, installation, maintenance, and use of devices and systems to vent combustion gases and pressures after any deflagration event. Consult with the manufacturer or installer of any dry dust collection system for applicable requirements before you install a new dry dust collection system or make significant changes in the process or materials used with an existing dry dust collection system.

Consult your local "Authority Having Jurisdiction" (AHJ) to determine whether any edition of NFPA 68 has been "adopted by reference" in your local building codes.

Refer to NFPA68 for definitions and explanations of regulatory terms such as deflagration, AHJ, adopted by reference, the Kst value, deflagration index, and other terms.

Note 1 – Hypertherm's interpretation of these new requirements is that unless a site-specific evaluation has been completed to determine that all dust generated is not combustible, the 2007 edition of NFPA 68 requires the use of explosion vents designed to the worst-case Kst value (see annex F) that could be generated from dust so that the explosion vent size and type can be designed. NFPA 68 does not specifically identify plasma cutting or other thermal cutting processes as requiring deflagration venting systems, but it does apply these new requirements to all dry dust collection systems.

Note 2 – Users of Hypertherm manuals should consult and comply with all applicable federal, state, and local laws and regulations. Hypertherm does not, by the publication of any Hypertherm manual, intend to urge action that is not in compliance with all applicable regulations and standards, and this manual may never be construed as doing so.



## Section 1a

# SÉCURITÉ

---

*Dans cette section :*

Identifier les consignes de sécurité .....	1a-2
Suivre les instructions de sécurité .....	1a-2
Le coupage peut provoquer un incendie ou une explosion .....	1a-2
Les chocs électriques peuvent être fatals .....	1a-3
L'électricité statique peut endommager les cartes de circuits imprimés .....	1a-3
Les vapeurs toxiques peuvent provoquer des blessures ou la mort .....	1a-4
L'arc plasma peut provoquer des blessures ou des brûlures .....	1a-5
Les rayons de l'arc peuvent brûler les yeux et la peau .....	1a-5
Mise à la masse et à la terre .....	1a-6
Sécurité des bouteilles de gaz comprimé .....	1a-6
Les bouteilles de gaz comprimé peuvent exploser en cas de dommages .....	1a-6
Le bruit peut provoquer des problèmes auditifs .....	1a-7
Pacemakers et prothèses auditives .....	1a-7
Un arc plasma peut endommager les tuyaux gelés .....	1a-7
Symboles et marquage .....	1a-8
Étiquettes de sécurité .....	1a-9
Information sur le dépoussiérage .....	1a-11



## IDENTIFIER LES CONSIGNES DE SÉCURITÉ

Les symboles indiqués dans cette section sont utilisés pour identifier les risques éventuels. Si vous trouvez un symbole de sécurité, que ce soit dans ce manuel ou sur l'équipement, soyez conscient des risques de blessures et suivez les instructions correspondantes afin d'éviter ces risques.



## SUIVRE LES INSTRUCTIONS DE SÉCURITÉ

Lire attentivement toutes les consignes de sécurité dans le présent manuel et sur les étiquettes de sécurité se trouvant sur la machine.

- Les étiquettes de sécurité doivent rester lisibles. Remplacer immédiatement les étiquettes manquantes ou abîmées.
- Apprendre à faire fonctionner la machine et à utiliser correctement les commandes. Ne laisser personne utiliser la machine sans connaître son fonctionnement.
- Garder la machine en bon état. Des modifications non autorisées sur la machine peuvent engendrer des problèmes de sécurité et raccourcir la durée d'utilisation de l'équipement.

## DANGER AVERTISSEMENT ATTENTION

Hypertherm adopte les lignes directrices de l'American National Standards Institute relativement aux termes, aux symboles et à la signalisation de sécurité. Les signaux DANGER ou AVERTISSEMENT sont utilisés avec un symbole de sécurité, DANGER correspondant aux risques les plus sérieux.

- Les étiquettes de sécurité DANGER et AVERTISSEMENT sont situées sur la machine pour signaler certains dangers spécifiques.
- Les messages de sécurité DANGER précèdent les directives associées dans le manuel qui, si elles ne sont pas suivies scrupuleusement, entraînent des blessures graves voire mortelles.
- Les messages d'AVERTISSEMENT précèdent les instructions d'utilisation expliquées dans ce manuel et signalent les risques de blessures ou de mort au cas où ces instructions ne seraient pas suivies correctement.
- Les messages de sécurité ATTENTION précèdent les directives associées dans le manuel qui, si elles ne sont pas suivies scrupuleusement, peuvent entraîner des blessures secondaires ou endommager l'équipement.



## LE COUPAGE PEUT PROVOQUER UN INCENDIE OU UNE EXPLOSION

### Prévention des incendies

- Avant de commencer, s'assurer que la zone de coupage ne présente aucun danger. Conserver un extincteur à proximité.
- Éloigner toute matière inflammable à une distance d'au moins 10 m du poste de coupage.
- Tremper le métal chaud ou le laisser refroidir avant de le manipuler ou avant de le mettre en contact avec des matériaux combustibles.
- Ne jamais couper des récipients pouvant contenir des matières inflammables avant de les avoir vidés et nettoyés correctement.
- Aérer toute atmosphère potentiellement inflammable avant d'utiliser un système plasma.
- Lors de l'utilisation d'oxygène comme gaz plasma, un système de ventilation par aspiration est nécessaire.

### Prévention des explosions

- Ne pas couper en présence de poussière ou de vapeurs.
- Ne pas couper de bouteilles, de tuyaux ou autres récipients fermés et pressurisés.
- Ne pas couper de récipients contenant des matières combustibles.



### AVERTISSEMENT

Risque d'explosion argon-hydrogène et méthane

L'hydrogène et le méthane sont des gaz inflammables et potentiellement explosifs. Conserver à l'écart de toute flamme les bouteilles et tuyaux contenant des mélanges à base d'hydrogène ou de méthane. Maintenir toute flamme et étincelle à l'écart de la torche lors de l'utilisation d'un plasma d'argon-hydrogène ou de méthane.



### AVERTISSEMENT

Détonation de l'hydrogène lors du coupage de l'aluminium

- Lors du coupage de l'aluminium sous l'eau, ou si l'eau touche la partie inférieure de la pièce d'aluminium, de l'hydrogène libre peut s'accumuler sous la pièce à couper et détonner lors du coupage plasma.
- Installer un collecteur d'aération au fond de la table à eau afin d'éliminer les risques de détonation de l'hydrogène. Se référer à l'annexe du manuel pour plus de renseignements sur les collecteurs d'aération.



## LES CHOCS ÉLECTRIQUES PEUVENT ÊTRE FATALS

Toucher une pièce électrique sous tension peut provoquer un choc électrique fatal ou des brûlures graves.

- La mise en fonctionnement du système plasma ferme un circuit électrique entre la torche et la pièce à couper. La pièce à couper et tout autre élément en contact avec cette pièce font partie du circuit électrique.
- Ne jamais toucher le corps de la torche, la pièce à couper ou l'eau de la table à eau pendant le fonctionnement du système plasma.

### Prévention des chocs électriques

Tous les systèmes plasma Hypertherm utilisent des hautes tensions pour le coupage (souvent de 200 à 400 V). On doit prendre les précautions suivantes quand on utilise le système plasma :

- Porter des bottes et des gants isolants et garder le corps et les vêtements au sec.
- Ne pas se tenir, s'asseoir ou se coucher sur une surface mouillée, ni la toucher quand on utilise le système plasma.
- S'isoler de la surface de travail et du sol en utilisant des tapis isolants secs ou des couvertures assez grandes pour éviter tout contact physique avec le travail ou le sol. S'il s'avère nécessaire de travailler dans ou près d'un endroit humide, procéder avec une extrême prudence.
- Installer un sectionneur avec fusibles appropriés, à proximité de la source de courant. Ce dispositif permet à l'opérateur d'arrêter rapidement la source de courant en cas d'urgence.
- En cas d'utilisation d'une table à eau, s'assurer que cette dernière est correctement mise à la terre.

- Installer et mettre à la terre l'équipement selon les instructions du présent manuel et conformément aux codes électriques locaux et nationaux.
- Inspecter fréquemment le cordon d'alimentation primaire pour s'assurer qu'il n'est ni endommagé, ni fendu. Remplacer immédiatement un cordon endommagé.  
**Un câble dénudé peut tuer.**
- Inspecter et remplacer les câbles de la torche qui sont usés ou endommagés.
- Ne pas saisir la pièce à couper ni les chutes lors du coupage. Laisser la pièce à couper en place ou sur la table de travail, le câble de retour connecté lors du coupage.
- Avant de vérifier, de nettoyer ou de remplacer les pièces de la torche, couper l'alimentation ou débrancher la prise de courant.
- Ne jamais contourner ou court-circuiter les verrouillages de sécurité.
- Avant d'enlever le capot du système ou de la source de courant, couper l'alimentation électrique. Attendre ensuite 5 minutes pour que les condensateurs se déchargent.
- Ne jamais faire fonctionner le système plasma sans que les capots de la source de courant ne soient en place. Les raccords exposés de la source de courant sont extrêmement dangereux.
- Lors de l'installation des connexions, attacher tout d'abord la prise de terre appropriée.
- Chaque système plasma Hypertherm est conçu pour être utilisé uniquement avec des torches Hypertherm spécifiques. Ne pas utiliser des torches inappropriées qui pourraient surchauffer et présenter des risques pour la sécurité.



## L'ÉLECTRICITÉ STATIQUE PEUT ENDOMMAGER LES CARTES DE CIRCUITS IMPRIMÉS

On doit prendre les précautions qui s'imposent quand on manipule les circuits imprimés.

- On doit ranger les cartes de circuits imprimés dans des contenants antistatiques.
- On doit porter un bracelet antistatique quand on manipule les cartes de circuits imprimés.



## LES VAPEURS TOXIQUES PEUVENT PROVOQUER DES BLESSURES OU LA MORT

L'arc plasma est lui-même la source de chaleur utilisée pour le coupage. Par conséquent, bien que l'arc plasma n'ait pas été reconnu comme une source de vapeurs toxiques, le matériau coupé peut être une source de vapeurs ou de gaz toxiques qui épuisent l'oxygène.

Les vapeurs produites varient selon le métal coupé. Les métaux qui peuvent dégager des vapeurs toxiques comprennent, entre autres, l'acier inoxydable, l'acier au carbone, le zinc (galvanisé) et le cuivre.

Dans certains cas, le métal peut être revêtu d'une substance susceptible de dégager des vapeurs toxiques. Les revêtements toxiques comprennent entre autres, le plomb (dans certaines peintures), le cadmium (dans certaines peintures et enduits) et le béryllium.

Les gaz produits par le coupage plasma varient selon le matériau à couper et la méthode de coupage, mais ils peuvent comprendre l'ozone, les oxydes d'azote, le chrome hexavalent, l'hydrogène et autres substances présentes dans le matériau coupé ou en émanent.

On doit prendre les précautions qui s'imposent pour réduire au minimum l'exposition aux vapeurs produites par tout processus industriel. Selon la composition chimique et la concentration des vapeurs (ainsi que d'autres facteurs comme la ventilation), il peut y avoir un risque de maladie physique, comme des malformations ou le cancer.

Il incombe au propriétaire du matériel et du site de vérifier la qualité de l'air dans le secteur où l'on utilise le matériel et de s'assurer que la qualité de l'air sur les lieux de travail répond aux normes et réglementation locales et nationales.

Le niveau de qualité de l'air dans tout lieu de travail dépend des variables propres au site comme :

- Type de table (humide, sèche, sous l'eau).
- Composition du matériau, fini de la surface et composition des revêtements.
- Volume de matériau enlevé.
- Durée du coupage ou du gougeage.
- Dimensions, volume d'air, ventilation et filtration de la zone de travail.
- Équipement de protection individuelle.
- Nombre de systèmes de soudage et de coupage en fonctionnement.
- Autres procédés du site qui peuvent produire des vapeurs.

Si les lieux de travail doivent être conformes aux règlements nationaux ou locaux, seuls les contrôles ou les essais effectués au site peuvent déterminer si celui-ci se situe au-dessus ou au-dessous des niveaux admissibles.

Pour réduire le risque d'exposition aux vapeurs :

- Éliminer tout revêtement et solvant du métal avant le coupage.
- Utiliser la ventilation d'extraction locale pour éliminer les vapeurs de l'air.
- Ne pas inhaler les vapeurs. Porter un respirateur à adduction d'air quand on coupe des métaux revêtus d'éléments toxiques ou qui en contiennent ou sont susceptibles d'en contenir.
- S'assurer que les personnes qui utilisent un matériel de soudage ou de coupage ainsi que les dispositifs de respiration par adduction d'air sont qualifiés et ont reçu la formation sur la bonne utilisation d'un tel matériel.
- Ne jamais couper les contenants dans lesquels il peut y avoir des matériaux toxiques. En premier lieu, vider et nettoyer correctement le contenant.
- Contrôler ou éprouver la qualité de l'air au site selon les besoins.
- Consulter un expert local pour mettre en œuvre un plan du site afin d'assurer une qualité de l'air sûre.



## L'ARC PLASMA PEUT PROVOQUER DES BLESSURES OU DES BRÛLURES

### Torches à allumage instantané

L'arc plasma s'allume immédiatement après que la torche soit mise en marche.

L'arc plasma coupe facilement les gants et la peau.

- Rester éloigné de l'extrémité de la torche.
- Ne pas tenir de métal près de la trajectoire de coupe.
- Ne jamais pointer la torche vers soi ou d'autres personnes.



## LES RAYONS DE L'ARC PEUVENT BRÛLER LES YEUX ET LA PEAU

**Protection des yeux** Les rayons de l'arc plasma produisent de puissants rayons visibles ou invisibles (ultraviolets et infrarouges) qui peuvent brûler les yeux et la peau.

- Utiliser des lunettes de sécurité conformément aux codes locaux ou nationaux en vigueur.
- Porter des lunettes de protection (lunettes ou masque muni d'écrans latéraux et encore masque de soudure) avec des verres teintés appropriés pour protéger les yeux des rayons ultraviolets et infrarouges de l'arc.

**Protection de la peau** Porter des vêtements de sécurité pour se protéger contre les brûlures que peuvent causer les rayons ultraviolets, les étincelles et le métal brûlant :

- Gants à crispin, chaussures et casque de sécurité.
- Vêtements ignifuges couvrant toutes les parties exposées du corps.
- Pantalon sans revers pour éviter que des étincelles ou des scories puissent s'y loger.
- Avant le coupage, retirer de ses poches tout objet combustible comme les briquets au butane ou les allumettes.

**Zone de coupage** Préparer la zone de coupage afin de réduire la réverbération et la transmission de la lumière ultraviolette :

- Peindre les murs et autres surfaces de couleur sombre pour réduire la réflexion de la lumière.
- Utiliser des écrans et autres dispositifs de protection afin de protéger les autres personnes de la lumière et de la réverbération.
- Prévenir les autres personnes de ne pas regarder l'arc. Utiliser des affiches ou des panneaux.

Courant de l'arc (A)	Indice de protection minimum (ANSI Z49.1:2005)	Indice de protection suggéré pour assurer le confort (ANSI Z49.1:2005)	OSHA 29CFR 1910.133(a)(5)	Europe EN168:2002
Moins de 40 A	5	5	8	9
41 à 60 A	6	6	8	9
61 à 80 A	8	8	8	9
81 à 125 A	8	9	8	9
126 à 150 A	8	9	8	10
151 à 175 A	8	9	8	11
176 à 250 A	8	9	8	12
251 à 300 A	8	9	8	13
301 à 400 A	9	12	9	13
401 à 800 A	10	14	10	



## MISE À LA MASSE ET À LA TERRE

**Câble de retour** Bien fixer le câble de retour (ou de masse) à la pièce à couper ou à la table de travail de façon à assurer un bon contact métal-métal. Ne pas fixer le câble de retour à la partie de la pièce qui doit se détacher.

**Table de travail** Raccorder la table de travail à la terre, conformément aux codes de sécurité locaux ou nationaux appropriés.

### Alimentation

- S'assurer que le fil de terre du cordon d'alimentation est connecté à la terre dans le coffret du sectionneur.
- S'il est nécessaire de brancher le cordon d'alimentation à la source de courant lors de l'installation du système, s'assurer que le fil de terre est correctement branché.
- Placer tout d'abord le fil de terre du cordon d'alimentation sur le plot de mise à la terre puis placer les autres fils de terre par-dessus. Bien serrer l'écrou de retenue.
- S'assurer que toutes les connexions sont bien serrées pour éviter la surchauffe.

## SÉCURITÉ DES BOUTEILLES DE GAZ COMPRIMÉ

- Ne jamais lubrifier les robinets des bouteilles ou les régulateurs avec de l'huile ou de la graisse.
- Utiliser uniquement les bouteilles, régulateurs, tuyaux et accessoires appropriés et conçus pour chaque application spécifique.
- Entretenir l'équipement et les pièces d'équipement à gaz comprimé afin de les garder en bon état.
- Étiqueter et coder avec des couleurs tous les tuyaux de gaz afin d'identifier le type de gaz contenu dans chaque tuyau. Se référer aux codes locaux ou nationaux en vigueur.



## LES BOUTEILLES DE GAZ COMPRIMÉ PEUVENT EXPLOSER EN CAS DE DOMMAGES

Les bouteilles de gaz contiennent du gaz à haute pression. Si une bouteille est endommagée, elle peut exploser.

- Manipuler et utiliser les bouteilles de gaz comprimé conformément aux codes locaux ou nationaux.
- Ne jamais utiliser une bouteille qui n'est pas placée à la verticale et bien assujettie.
- Le capuchon de protection doit être placé sur le robinet sauf si la bouteille est en cours d'utilisation ou connectée pour utilisation.
- Éviter à tout prix le contact électrique entre l'arc plasma et une bouteille.
- Ne jamais exposer des bouteilles à une chaleur excessive, aux étincelles, aux scories ou aux flammes nues.
- Ne jamais utiliser des marteaux, des clés ou d'autres outils pour débloquer le robinet des bouteilles.



**LE BRUIT PEUT PROVOQUER  
DES PROBLÈMES AUDITIFS**

Une exposition prolongée au bruit du coupage ou du gougeage peut provoquer des problèmes auditifs.

- Utiliser un casque de protection homologué lors de l'utilisation du système plasma.
- Prévenir les personnes aux alentours des risques encourus en cas d'exposition au bruit.

**UN ARC PLASMA PEUT  
ENDOMMAGER LES  
TUYAUX GELÉS**

Les tuyaux gelés peuvent être endommagés ou éclater si l'on essaie de les dégeler avec une torche plasma.

**PACEMAKERS ET  
PROTHÈSES AUDITIVES**

Les champs magnétiques produits par les courants à haute tension peuvent affecter le fonctionnement des prothèses auditives et des pacemakers.

Les personnes portant ce type d'appareil doivent consulter un médecin avant de s'approcher d'un lieu où s'effectue le coupage ou le gougeage plasma.

Pour réduire les risques associés aux champs magnétiques :

- Garder loin de soi et du même côté du corps le câble de retour et le faisceau de la torche.
- Faire passer le faisceau de la torche le plus près possible du câble de retour.
- Ne pas s'enrouler le faisceau de la torche ou le câble de retour autour du corps.
- Se tenir le plus loin possible de la source de courant.

## SYMBOLES ET MARQUAGE

Votre produit Hypertherm peut comporter une ou plusieurs des marques suivantes sur sa plaque signalétique ou à proximité. En raison des différends et des conflits relatifs aux règlements nationaux, toutes les marques ne sont pas appliquées à chaque version d'un produit.



### Symbole marque S

Le symbole de marque S indique que la source de courant et la torche conviennent pour les travaux effectués dans les milieux à risque accru de choc électrique selon l'IEC 60974-1.



### Marque CSA

Les produits Hypertherm comportant la marque CSA répondent aux règlements des États-Unis et du Canada relatifs à la sécurité du produit. Les produits sont évalués, mis à l'essai et certifiés par la CSA-International. En outre, le produit peut porter une marque d'un des laboratoires d'essai reconnus sur le plan national (NRTL) accrédité aux États-Unis et au Canada comme les Underwriters Laboratories, Incorporated (UL) ou TÜV.



### Marque CE

La marque CE signifie la déclaration de conformité du fabricant aux directives et normes européennes applicables. Seules les versions des produits Hypertherm portant la marque CE placée sur la plaque signalétique ou à proximité ont été mises à l'essai de conformité à la directive européenne sur la basse tension et la compatibilité électromagnétique européenne (CEM). Les filtres CEM qui doivent se conformer à la directive CEM européenne sont intégrés aux versions du produit portant la marque CE.



### Marque GOST-R

Les versions CE des produits Hypertherm qui portent la marque de conformité GOST-R répondent aux exigences de sécurité du produit et de CEM en vue de l'exportation à la Fédération russe.



### Marque c-Tick

Les versions CE des produits Hypertherm portant la marque c-Tick sont conformes aux règlements CEM prescrits pour la vente en Australie et en Nouvelle-Zélande.











### Marque CCC

La marque de certification obligatoire en Chine (CCC) indique que le produit a été mis à l'essai et déclaré conforme aux règlements de sécurité du produit prescrits pour la vente en Chine.

## ÉTIQUETTE DE SÉCURITÉ

Cette étiquette est affichée sur la source de courant. Il est important que l'utilisateur et le technicien de maintenance comprennent la signification des symboles de sécurité. Les numéros de la liste correspondent aux numéros des images.

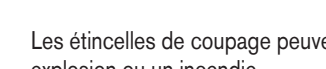
 Read and follow these instructions, employer safety practices, and material safety data sheets. Refer to ANS Z49.1, "Safety in Welding, Cutting and Allied Processes" from American Welding Society ( <a href="http://www.aws.org">http://www.aws.org</a> ) and OSHA Safety and Health Standards, 29 CFR 1910 ( <a href="http://www.osha.gov">http://www.osha.gov</a> ).		 <b>WARNING</b>		 <b>AVERTISSEMENT</b>	
		Plasma cutting can be injurious to operator and persons in the work area. Consult manual before operating. Failure to follow all these safety instructions can result in death.		Le coupage plasma peut être préjudiciable pour l'opérateur et les personnes qui se trouvent sur les lieux de travail. Consulter le manuel avant de faire fonctionner. Le non respect des ces instructions de sécurité peut entraîner la mort.	
		<b>1. Cutting sparks can cause explosion or fire.</b> 1.1 Do not cut near flammables. 1.2 Have a fire extinguisher nearby and ready to use. 1.3 Do not use a drum or other closed container as a cutting table.		<b>1. Les étincelles de coupage peuvent provoquer une explosion ou un incendie.</b> 1.1 Ne pas couper près des matières inflammables. 1.2 Un extincteur doit être à proximité et prêt à être utilisé. 1.3 Ne pas utiliser un fût ou un autre contenant fermé comme table de coupage.	
		<b>2. Plasma arc can injure and burn; point the nozzle away from yourself. Arc starts instantly when triggered.</b> 2.1 Turn off power before disassembling torch. 2.2 Do not grip the workpiece near the cutting path. 2.3 Wear complete body protection.		<b>2. L'arc plasma peut blesser et brûler; éloigner la buse de soi. Il s'allume instantanément quand on l'amorce;</b> 2.1 Couper l'alimentation avant de démonter la torche. 2.2 Ne pas saisir la pièce à couper de la trajectoire de coupage. 2.3 Se protéger entièrement le corps.	
		<b>3. Hazardous voltage. Risk of electric shock or burn.</b> 3.1 Wear insulating gloves. Replace gloves when wet or damaged. 3.2 Protect from shock by insulating yourself from work and ground. 3.3 Disconnect power before servicing. Do not touch live parts.		<b>3. Tension dangereuse. Risque de choc électrique ou de brûlure.</b> 3.1 Porter des gants isolants. Remplacer les gants quand ils sont humides ou endommagés. 3.2 Se protéger contre les chocs en s'isolant de la pièce et de la terre. 3.3 Couper l'alimentation avant l'entretien. Ne pas toucher les pièces sous tension.	
		<b>4. Plasma fumes can be hazardous.</b> 4.1 Do not inhale fumes. 4.2 Use forced ventilation or local exhaust to remove the fumes. 4.3 Do not operate in closed spaces. Remove fumes with ventilation.		<b>4. Les fumées plasma peuvent être dangereuses.</b> 4.1 Ne pas inhaler les fumées 4.2 Utiliser une ventilation forcée ou un extracteur local pour dissiper les fumées. 4.3 Ne pas couper dans des espaces clos. Chasser les fumées par ventilation.	
		<b>5. Arc rays can burn eyes and injure skin.</b> 5.1 Wear correct and appropriate protective equipment to protect head, eyes, ears, hands, and body. Button shirt collar. Protect ears from noise. Use welding helmet with the correct shade of filter.		<b>5. Les rayons d'arc peuvent brûler les yeux et blesser la peau.</b> 5.1 Porter un bon équipement de protection pour se protéger la tête, les yeux, les oreilles, les mains et le corps. Boutonner le col de la chemise. Protéger les oreilles contre le bruit. Utiliser un masque de soudeur avec un filtre de nuance appropriée.	
		<b>6. Become trained.</b> Only qualified personnel should operate this equipment. Use torches specified in the manual. Keep non-qualified personnel and children away.		<b>6. Suivre une formation.</b> Seul le personnel qualifié a le droit de faire fonctionner cet équipement. Utiliser exclusivement les torches indiquées dans le manuel. Le personnel non qualifié et les enfants doivent se tenir à l'écart.	
		<b>7. Do not remove, destroy, or cover this label.</b> Replace if it is missing, damaged, or worn (PN 110584 Rev C).		<b>7. Ne pas enlever, détruire ni couvrir cette étiquette.</b> La remplacer si elle est absente, endommagée ou usée (PN 110584 Rev C).	

1. Les étincelles de coupage peuvent provoquer une explosion ou un incendie.
  - 1.1 Ne pas couper près des matières inflammables.
  - 1.2 Un extincteur doit se trouver sur les lieux et prêt à être utilisé.
  - 1.3 Ne pas utiliser un fût ou un autre contenant fermé comme table de coupe.
2. L'arc plasma peut blesser et brûler ; ne jamais pointer la buse vers soi. L'arc s'amorce instantanément quand on appuie sur la gâchette.
  - 2.1 Couper l'alimentation avant de démonter la torche.
  - 2.2 Ne pas saisir la pièce près de la trajectoire de coupage.
  - 2.3 Se protéger entièrement le corps.
3. Tension dangereuse. Risque de choc électrique ou de brûlure.
  - 3.1 Porter des gants isolants. Remplacer les gants s'ils sont humides ou endommagés.
  - 3.2 Se protéger contre les chocs en s'isolant de la pièce et de la terre.
  - 3.3 Couper l'alimentation avant d'entretenir. Ne pas toucher les pièces sous tension.
4. Les fumées du plasma peuvent être dangereuses.
  - 4.1 Ne pas inhaler les fumées.
  - 4.2 Utiliser une ventilation forcée ou par aspiration à la source pour éliminer les fumées.
  - 4.3 Ne pas utiliser dans des espaces clos. Chasser les fumées avec la ventilation.
5. Les rayons d'arc peuvent brûler les yeux et blesser la peau.
  - 5.1 Porter un bon équipement de protection pour se protéger la tête, les yeux, les oreilles, les mains et le corps. Boutonner le col de la chemise. Se protéger les oreilles contre le bruit. Utiliser le masque de soudage avec le filtre ayant le bon indice de protection.
6. S'entraîner. Seul le personnel qualifié doit faire fonctionner cet équipement. Utiliser les torches prescrites dans le manuel. Tenir le personnel non qualifié et les enfants à l'écart.
7. Ne pas enlever, détruire ou couvrir cette étiquette. La remplacer si elle est manquante, endommagée ou usée.

## ÉTIQUETTE DE SÉCURITÉ

Cette étiquette est affichée sur la source de courant. Il est important que l'utilisateur et le technicien de maintenance comprennent la signification des symboles de sécurité. Les numéros de la liste correspondent aux numéros des images.



1. Les étincelles de coupage peuvent provoquer une explosion ou un incendie.
  - 1.1 Ne pas couper près des matières inflammables.
  - 1.2 Un extincteur doit se trouver sur les lieux et prêt à être utilisé.
  - 1.3 Ne pas utiliser un fût ou un autre contenant fermé comme table de coupe.
2. L'arc plasma peut blesser et brûler ; ne jamais pointer la buse vers soi. L'arc s'amorce instantanément quand on appuie sur la gâchette.
  - 2.1 Couper l'alimentation avant de démonter la torche.
  - 2.2 Ne pas saisir la pièce près de la trajectoire de coupage.
  - 2.3 Se protéger entièrement le corps.
3. Tension dangereuse. Risque de choc électrique ou de brûlure.
  - 3.1 Porter des gants isolants. Remplacer les gants s'ils sont humides ou endommagés.
  - 3.2 Se protéger contre les chocs en s'isolant de la pièce et de la terre.
  - 3.3 Couper l'alimentation avant d'entretenir. Ne pas toucher les pièces sous tension.
4. Les fumées du plasma peuvent être dangereuses.
  - 4.1 Ne pas inhaler les fumées.
  - 4.2 Utiliser une ventilation forcée ou par aspiration à la source pour éliminer les fumées.
  - 4.3 Ne pas utiliser dans des espaces clos. Chasser les fumées avec la ventilation.
5. Les rayons d'arc peuvent brûler les yeux et blesser la peau.
  - 5.1 Porter un bon équipement de protection pour se protéger la tête, les yeux, les oreilles, les mains et le corps. Boutonner le col de la chemise. Se protéger les oreilles contre le bruit. Utiliser le masque de soudage avec le filtre ayant le bon indice de protection.
6. S'entraîner. Seul le personnel qualifié doit faire fonctionner cet équipement. Utiliser les torches prescrites dans le manuel. Tenir le personnel non qualifié et les enfants à l'écart.
7. Ne pas enlever, détruire ou couvrir cette étiquette. La remplacer si elle est manquante, endommagée ou usée.

## **INFORMATION SUR LE DÉPOUSSIÉRAGE**

À certains endroits, la poussière peut représenter un risque d'explosion potentiel. À certains endroits, la poussière peut représenter un risque d'explosion potentiel.

La norme NFPA 68 de la National Fire Protection Association des É.-U. (édition 2007) « Explosion Protection by Deflagration Venting » établit les exigences relatives à la conception, à l'emplacement, à l'installation, à l'entretien et à l'utilisation de dispositifs et de systèmes pour évacuer à l'air libre les gaz de combustion et les pressions après une éventuelle déflagration. Communiquer avec le fabricant ou avec l'installateur pour tout système de dépoussiérage afin de connaître les exigences applicables avant d'installer un tel système neuf ou d'apporter des modifications importantes aux procédés ou aux matériaux utilisés à un système de dépoussiérage existant.

Consultez l'autorité compétente locale pour déterminer si une édition de la NFPA 68 a été adoptée par référence dans vos codes du bâtiment locaux.

Voir le document NFPA68 pour obtenir des définitions et des explications des termes réglementaires tels que « déflagration, autorité compétente, adopté par référence, valeur du pire cas, indice de déflagration » et autres termes.

Note 1 – L'interprétation d'Hypertherm de ces nouvelles exigences est que, sauf évaluation particulière du site, pour déterminer que toute la poussière produite n'est pas combustible, l'édition 2007 de la NFPA 68 exige l'utilisation d'événements d'explosion conçus pour la valeur du pire des cas (voir annexe F) qui pourrait provenir de la poussière de sorte que l'on puisse concevoir la dimension et le type d'événement d'explosion. La NFPA 68 ne stipule pas particulièrement le procédé de coupage plasma particulier ou autres procédés de coupage thermique comme le prescrivent ces nouveaux règlements à tous les systèmes de dépoussiérage.

Note 2 – Les utilisateurs des manuels d'Hypertherm doivent consulter tous les règlements et lois fédéraux et locaux applicables et s'y conformer. Hypertherm n'a pas l'intention, en publiant un manuel d'Hypertherm, de demander des mesures qui ne sont pas conformes aux règlements et normes applicables et ce manuel ne peut jamais être interprété dans ce sens.



## Sección 1b

# SEGURIDAD

---

*En esta sección:*

Reconocimiento de información de seguridad .....	1b-2
Siga las instrucciones de seguridad .....	1b-2
Los cortes pueden provocar incendios o explosiones .....	1b-2
El choque eléctrico puede provocar la muerte .....	1b-3
Electricidad estática puede dañar tablillas de circuito .....	1b-3
Humos tóxicos pueden causar lesiones o muerte .....	1b-4
El arco de plasma puede causar lesiones y quemaduras .....	1b-5
Los rayos del arco pueden producir quemaduras en los ojos y en la piel .....	1b-5
Seguridad de toma a tierra .....	1b-6
Seguridad de los equipos de gas comprimido .....	1b-6
Los cilindros de gas pueden explotar si están dañados .....	1b-6
El ruido puede deteriorar la audición .....	1b-7
Operación de marcapasos y de audífonos .....	1b-7
Un arco plasma puede dañar tubos congelados .....	1b-7
Símbolos y marcas .....	1b-8
Etiquetas de advertencia .....	1b-9
Información sobre la colección de polvo seco .....	1b-11



## RECONOCIMIENTO DE INFORMACIÓN DE SEGURIDAD

Los símbolos que se muestran en esta sección se utilizan para identificar los posibles peligros. Cuando vea un símbolo de seguridad en este manual o en su máquina, recuerde que existe la posibilidad de que se produzcan lesiones personales y siga las instrucciones correspondientes para evitar el peligro.



## SIGA LAS INSTRUCCIONES DE SEGURIDAD

Lea atentamente todos los mensajes de seguridad de este manual y las etiquetas de seguridad en su máquina.

- Mantenga las etiquetas de seguridad de su máquina en buen estado. Reemplace las etiquetas que se pierdan o se dañen inmediatamente.
- Aprenda a utilizar la máquina y a utilizar los controles de la manera correcta. No permita que sea utilizada por alguien que no conozca su funcionamiento.
- Mantenga su máquina en buenas condiciones de funcionamiento. La realización de modificaciones no autorizadas a la máquina puede comprometer la seguridad y la vida útil de la máquina.

## PELIGRO ADVERTENCIA PRECAUCIÓN

Hypertherm usa las directivas del Instituto Americano de Normas Nacionales (American National Standards Institute) para las palabras y símbolos que señalan seguridad. Las palabras PELIGRO y ADVERTENCIA se utilizan conjuntamente con un símbolo de seguridad. La palabra PELIGRO se utiliza para identificar los mayores peligros.

- Encontrará etiquetas de seguridad con las inscripciones PELIGRO y ADVERTENCIA en su máquina, junto a peligros específicos.
- Los mensajes de seguridad de PELIGRO preceden instrucciones relacionadas en el manual que resultarán en lesión grave o muerte si no se las sigue correctamente.
- En este manual, la palabra ADVERTENCIA va seguida de instrucciones que, si no se siguen correctamente, pueden provocar lesiones e inclusive la muerte.
- Los mensajes de seguridad de CUIDADO o PRECAUCIÓN preceden mensajes relacionados con instrucciones en el manual que puede resultar en lesiones menores, o daño a equipo, si no se siguen correctamente.



## LOS CORTES PUEDEN PROVOCAR INCENDIOS O EXPLOSIONES

### Prevención ante el fuego

- Asegúrese de que el área sea segura antes de proceder a cortar. Tenga a mano un extinguidor de incendios.
- Retire todos los materiales inflamables, colocándolos a por lo menos 10 metros del área de corte.
- Remoje los metales calientes o permita que se enfríen antes de que entren en contacto con materiales combustibles.
- Nunca corte depósitos que contengan materiales inflamables – primero es necesario vaciarlos y limpiarlos debidamente.
- Antes de realizar cortes en atmósferas potencialmente inflamables, asegúrese de ventilar bien.
- Al realizar cortes utilizando oxígeno como gas plasma, se requiere tener un sistema de ventilación de escape.

### Prevención ante explosiones

- No corte en atmósferas que contengan polvo o vapores explosivos.
- No corte depósitos o tubos a presión ni cualquier depósito cerrado.
- No corte depósitos que hayan contenido materiales combustibles.



### ADVERTENCIA

Peligro de explosión  
Argón-Hidrógeno y metano

El hidrógeno y el metano son gases inflamables que suponen un peligro de explosión. Mantenga el fuego lejos de los cilindros y las mangueras que contengan mezclas de hidrógeno o metano. Mantenga la llama y las chispas lejos de la antorcha al utilizar metano o argón-hidrógeno como plasma.



### ADVERTENCIA

Detonación de hidrógeno con  
el corte de aluminio

- Al cortar aluminio bajo agua o con agua en contacto con el lado inferior del aluminio, puede acumularse gas hidrógeno bajo la pieza a cortar y detonar durante la operación de corte por plasma.
- Instale un múltiple de aireación en el fondo de la mesa de agua para eliminar la posibilidad de la detonación del hidrógeno. Consulte la sección del apéndice de este manual para conocer detalles acerca del múltiple de aireación.





## EL CHOQUE ELÉCTRICO PUEDE PROVOCAR LA MUERTE

El contacto directo con piezas eléctricas conectadas puede provocar un electrochoque fatal o quemaduras graves.

- Al hacer funcionar el sistema de plasma, se completa un circuito eléctrico entre la antorcha y la pieza a cortar. La pieza a cortar es una parte del circuito eléctrico, como también cualquier cosa que se encuentre en contacto con ella.
- Nunca toque el cuerpo de la antorcha, la pieza a cortar o el agua en una mesa de agua cuando el sistema de plasma se encuentre en funcionamiento.

### Prevención ante el electrochoque

Todos los sistemas por plasma de Hypertherm usan alto voltaje en el proceso de corte (son comunes los voltajes CD de 200 a 400). Tome las siguientes precauciones cuando se utiliza el equipo de plasma:

- Use guantes y botas aislantes y mantenga el cuerpo y la ropa secos.
- No se siente, se pare o se ponga sobre cualquier superficie húmeda cuando esté trabajando con el equipo.
- Aíslese eléctricamente de la pieza a cortar y de la tierra utilizando alfombrillas o cubiertas de aislamiento secas lo suficientemente grandes como para impedir todo contacto físico con la pieza a cortar o con la tierra. Si su única opción es trabajar en una área húmeda o cerca de ella, sea muy cauteloso.
- Instale un interruptor de corriente adecuado en cuanto a fusibles, en una pared cercana a la fuente de energía. Este interruptor permitirá al operador desconectar rápidamente la fuente de energía en caso de emergencia.
- Al utilizar una mesa de agua, asegúrese de que ésta se encuentre correctamente conectada a la toma a tierra.

- Instale este equipo y conéctelo a tierra según el manual de instrucciones y de conformidad con los códigos locales y nacionales.
- Inspeccione el cordón de alimentación primaria con frecuencia para asegurarse de que no esté dañado ni agrietado. Si el cordón de alimentación primaria está dañado, reemplácelo inmediatamente. **Un cable pelado puede provocar la muerte.**
- Inspeccione las mangueras de la antorcha y reemplácelas cuando se encuentren dañadas.
- No toque la pieza ni los recortes cuando se está cortando. Deje la pieza en su lugar o sobre la mesa de trabajo con el cable de trabajo conectado en todo momento.
- Antes de inspeccionar, limpiar o cambiar las piezas de la antorcha, desconecte la potencia primaria o desenchufe la fuente de energía.
- Nunca evite o descuide los bloqueos de seguridad.
- Antes de retirar la cubierta de una fuente de energía o del gabinete de un sistema, desconecte la potencia primaria de entrada. Espere 5 minutos después de desconectar la potencia primaria para permitir la descarga de los condensadores.
- Nunca opere el sistema de plasma sin que las tapas de la fuente de energía estén en su lugar. Las conexiones expuestas de la fuente de energía presentan un serio riesgo eléctrico.
- Al hacer conexiones de entrada, conecte el conductor de conexión a tierra en primer lugar.
- Cada sistema de plasma Hypertherm está diseñado para ser utilizado sólo con antorchas Hypertherm específicas. No utilice antorchas diferentes, que podrían recalentarse y ser peligrosas.



## ELECTRICIDAD ESTÁTICA PUEDE DAÑAR TABLILLAS DE CIRCUITO

Use precauciones adecuadas cuando maneje tablillas impresas de circuito

- Almacene las tablillas PC en recipientes antiestáticos.
- Use la defensa de muñeca conectada a tierra cuando maneje tablillas PC.



## HUMOS TÓXICOS PUEDEN CAUSAR LESIONES O MUERTE

El arco plasma es por sí solo la fuente de calor que se usa para cortar. Según esto, aunque el arco de plasma no ha sido identificado como la fuente de humo tóxico, el material que se corta puede ser la fuente de humo o gases tóxicos que vacían el oxígeno.

El humo producido varía según el metal que está cortándose. Metales que pueden liberar humo tóxico incluyen, pero no están limitados a, acero inoxidable, acero al carbón, cinc (galvanizado), y cobre.

En algunos casos, el metal puede estar recubierto con una sustancia que podría liberar humos tóxicos. Los recubrimientos tóxicos incluyen, pero no están limitados a, plomo (en algunas pinturas), cadmio (en algunas pinturas y rellenos), y berilio.

Los gases producidos por el corte por plasma varían basándose en el material a cortarse y el método de cortar, pero pueden incluir ozono, óxidos de nitrógeno, cromo hexavalente, hidrógeno, y otras sustancias, si están contenidas dentro o liberadas por el material que se corta.

Se debe tener cuidado de minimizar la exposición del humo producido por cualquier proceso industrial. Según la composición química y la concentración del humo (al igual que otros factores, tales como ventilación), puede haber el riesgo de enfermedad física, tal como defectos de natiidad o cáncer.

Es la responsabilidad del dueño del equipo y instalación el comprobar la calidad de aire en el lugar donde se está usando el equipo para garantizar que la calidad del aire en el lugar de trabajo cumpla con todas las normas y reglamentos locales y nacionales.

El nivel de la calidad del aire en cualquier lugar de trabajo relevante depende en variables específicas al sitio tales como:

- Diseño de mesa (mojada, seca, bajo agua).
- La composición del material, el acabado de la superficie, y la composición de los recubrimientos.
- Volumen que se quita del material.
- La duración del corte o ranura.
- Tamaño, volumen del aire, ventilación y filtración del lugar de trabajo.
- Equipo de protección personal.
- Número de sistemas de soldar y cortar en la operación.
- Otros procesos del lugar que pueden producir humo.

Si el lugar de trabajo debe cumplir reglamentos nacionales o locales, solamente el monitoreo o las pruebas que se hacen en el lugar pueden determinar si el sitio está encima o debajo de los niveles permitidos.

Para reducir el riesgo de exposición a humo:

- Quite todos los recubrimientos y solventes del metal antes de cortar.
- Use ventilación extractora local para quitar humo del aire.
- No inhale el humo. Use un respirador con fuente propia de aire cuando corte cualquier metal recubierto con, o sospechado de contener, elementos tóxicos.
- Garantice que aquéllos usando equipo de soldar o cortar, al igual que aparatos de respiración con aire propio de aire, estén capacitados y entrenados en el uso apropiado de tal equipo.
- Nunca corte recipientes con materiales potencialmente tóxicos adentro. Primero, vacíe y limpie el recipiente adecuadamente.
- Monitoree o compruebe la calidad del aire en el sitio como fuera necesario.
- Consulte con un experto local para realizar un plan al sitio para garantizar la calidad de aire seguro.



**EL ARCO DE PLASMA PUEDE CAUSAR LESIONES Y QUEMADURAS**

**Antorchas de encendido instantáneo**

El arco de plasma se enciende inmediatamente después de activarse el interruptor de la antorcha.

El arco de plasma puede cortar a través de guantes y de la piel con rapidez.

- Manténgase alejado de la punta de la antorcha.
- No sostenga el metal junto al trayecto de corte.
- Nunca apunte la antorcha hacia Ud. mismo o hacia otras personas.



**LOS RAYOS DEL ARCO PUEDEN PRODUCIR QUEMADURAS EN LOS OJOS Y EN LA PIEL**

**Protección para los ojos** Los rayos del arco de plasma producen rayos intensos visibles e invisibles (ultravioleta e infrarrojo) que pueden quemar los ojos y la piel.

- Utilice protección para los ojos de conformidad con los códigos locales o nacionales aplicables.
- Colóquese protectores para los ojos (gafas o anteojos protectores con protectores laterales, y bien un casco de soldar) con lentes con sombreado adecuado para proteger sus ojos de los rayos ultravioleta e infrarrojos del arco.

**Protección para la piel** Vista ropa de protección para proteger la piel contra quemaduras causadas por la radiación ultravioleta de alta intensidad, por las chispas y por el metal caliente:

- Guantes largos, zapatos de seguridad y gorro.
- Ropa de combustión retardada y que cubra todas las partes expuestas.
- Pantalones sin dobladillos para impedir que recojan chispas y escorias.
- Retire todo material combustible de los bolsillos, como encendedores a butano e inclusive cerillas, antes de comenzar a cortar.

**Área de corte** Prepare el área de corte para reducir la reflexión y la transmisión de la luz ultravioleta:

- Pinte las paredes y demás superficies con colores oscuros para reducir la reflexión.
- Utilice pantallas o barreras protectoras para proteger a los demás de los destellos.
- Advierta a los demás que no debe mirarse el arco. Utilice carteles o letreros.

Corriente de arco (amps.)	El número de matiz protector mínimo (ANSI Z49.1:2005)	El número de matiz sugerido para comodidad (ANSI Z49.1:2005)	OSHA 29CFR 1910.133(a)(5)	Europa EN168:2002
Menos de 40 A	5	5	8	9
41 a 60 A	6	6	8	9
61 a 80 A	8	8	8	9
81 a 125 A	8	9	8	9
126 a 150 A	8	9	8	10
151 a 175 A	8	9	8	11
176 a 250 A	8	9	8	12
251 a 300 A	8	9	8	13
301 a 400 A	9	12	9	13
401 a 800 A	10	14	10	



## SEGURIDAD DE TOMA A TIERRA

**Cable de trabajo** La pinza del cable de trabajo debe estar bien sujeta a la pieza y hacer un buen contacto de metal a metal con ella o bien con la mesa de trabajo. No conecte el cable con la parte que va a quedar separada por el corte.

**Mesa de trabajo** Conecte la mesa de trabajo a una buena toma de tierra, de conformidad con los códigos eléctricos nacionales o locales apropiados.

### Potencia primaria de entrada

- Asegúrese de que el alambre de toma a tierra del cordón de alimentación está conectado al terminal de tierra en la caja del interruptor de corriente.
- Si la instalación del sistema de plasma supone la conexión del cordón de alimentación primaria a la fuente de energía, asegúrese de conectar correctamente el alambre de toma a tierra del cordón de alimentación primaria.
- Coloque en primer lugar el alambre de toma a tierra del cordón de alimentación primaria en el espárrago luego coloque cualquier otro alambre de tierra sobre el conductor de tierra del cable. Ajuste firmemente la tuerca de retención.
- Asegúrese de que todas las conexiones eléctricas están firmemente realizadas para evitar sobrecalentamientos.

## SEGURIDAD DE LOS EQUIPOS DE GAS COMPRIMIDO

- Nunca lubrique reguladores o válvulas de cilindros con aceite o grasa.
- Utilice solamente cilindros, reguladores, mangueras y conectores de gas correctos que hayan sido diseñados para la aplicación específica.
- Mantenga todo el equipo de gas comprimido y las piezas relacionadas en buen estado.
- Coloque etiquetas y códigos de color en todas las mangueras de gas para identificar el tipo de gas que conduce cada una. Consulte los códigos locales o nacionales aplicables.



## LOS CILINDROS DE GAS PUEDEN EXPLOTAR SI ESTÁN DAÑADOS

Los cilindros de gas contienen gas bajo alta presión. Un cilindro dañado puede explotar.

- Manipule y utilice los cilindros de gas comprimido de acuerdo con los códigos locales o nacionales aplicables.
- No use nunca un cilindro que no esté de pie y bien sujeto.
- Mantenga la tapa de protección en su lugar encima de la válvula, excepto cuando el cilindro se encuentre en uso o conectado para ser utilizado.
- No permita nunca el contacto eléctrico entre el arco de plasma y un cilindro.
- No exponga nunca los cilindros a calor excesivo, chispas, escorias o llamas.
- No emplee nunca martillos, llaves u otro tipo de herramientas para abrir de golpe la válvula del cilindro.



### **EL RUIDO PUEDE DETERIORAR LA AUDICIÓN**

La exposición prolongada al ruido propio de las operaciones de corte y ranurado puede dañar la audición.

- Utilice un método de protección de los oídos aprobado al utilizar el sistema de plasma.
- Advierta a las demás personas que se encuentren en las cercanías acerca del peligro que supone el ruido excesivo.

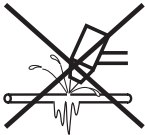

### **UN ARCO PLASMA PUEDE DAÑAR TUBOS CONGELADOS**

Se puede hacer daño a los tubos congelados, o se los puede reventar, si uno trata de descongelarlos con una antorcha por plasma.



### **OPERACIÓN DE MARCAPASOS Y DE AUDÍFONOS**

Los campos magnéticos producidos por las elevadas corrientes pueden afectar la operación de marcapasos y de audífonos.

Las personas que lleven marcapasos y audífonos deberán consultar a un médico antes de acercarse a sitios donde se realizan operaciones de corte y ranurado por plasma.

Para reducir los peligros de los campos magnéticos:

- Mantenga el cable de trabajo y la manguera de la antorcha a un lado, lejos del cuerpo.
- Dirija la manguera antorcha lo más cerca posible del cable de trabajo.
- No envuelva el cable de trabajo ni la manguera de la antorcha en su cuerpo.
- Manténgase tan lejos de la fuente de energía como sea posible.

## SÍMBOLOS Y MARCAS

Su producto de Hypertherm puede tener una o más de las marcas que siguen en, o cerca de la placa de datos. Debido a diferencias y conflictos en reglamentos nacionales, no todas las marcas se aplican a toda versión del producto.



### Símbolo de marca S

El símbolo de marca S indica que la fuente de energía y antorcha son aptas para operaciones que se llevan a cabo en entornos con peligro aumentado de choque o descarga eléctrica según IEC 60974-1.



### Marca CSA

Los productos de Hypertherm con la marca CSA cumplen con los reglamentos de Estados Unidos y Canadá para la seguridad del producto. Estos productos fueron evaluados, comprobados, y certificados por CSA-Internacional. Alternativamente, el producto puede tener la marca según uno de los otros Laboratorios de Prueba Reconocidos nacionalmente (NRTL siglas en inglés) acreditados en ambos Estados Unidos y Canadá, tales como Underwriters Laboratories, Incorporated (UL) ó TÜV.



### Marcas CE

Las marcas CE significan una declaración del fabricante de conformidad a las directivas y estándares aplicables Europeos. Sólo aquellas versiones del producto Hypertherm con la marca CE ubicada en o cerca de la placa de datos han sido comprobadas para cumplir con la Directiva Europea de Voltaje Bajo, la Compatibilidad Electromagnética Europea (EMC). Los filtros EMC que necesitan cumplir con la Directiva Europea EMC están incorporados dentro de las versiones del producto con la marca CE.



### Marca GOST-R

Las versiones de los productos Hypertherm CE que incluye la marca de conformidad GOST-R cumplen con la seguridad del productos y los requisitos EMC para exportarse a la Federación Rusa.



### Marca c-Tick

Las versiones CE de los productos Hypertherm con la marca c-Tick cumple con los reglamentos EMC requeridos para venta en Australia y Nueva Zelanda.



### Marca CCC

La marca de Certificación Obligatoria China (CCC en inglés) indica que el producto ha sido comprobado y se lo ha encontrado que cumple con los reglamentos de seguridad del producto requeridos para venta en China.

**ETIQUETA DE ADVERTENCIA**

Esta etiqueta de advertencia se encuentra adherida a la fuente de energía. Es importante que el operador y el técnico de mantenimiento comprendan el sentido de estos símbolos de advertencia según se describen. El texto numerado corresponde a los cuadros numerados de la etiqueta.

	Read and follow these instructions, employer safety practices, and material safety data sheets. Refer to ANS Z49.1, "Safety in Welding, Cutting and Allied Processes" from American Welding Society ( <a href="http://www.aws.org">http://www.aws.org</a> ) and OSHA Safety and Health Standards, 29 CFR 1910 ( <a href="http://www.osha.gov">http://www.osha.gov</a> ).	<b>WARNING</b>	<b>AVERTISSEMENT</b>
1		<b>1. Cutting sparks can cause explosion or fire.</b> 1.1 Do not cut near flammables. 1.2 Have a fire extinguisher nearby and ready to use. 1.3 Do not use a drum or other closed container as a cutting table.	<b>1. Les étincelles de coupage peuvent provoquer une explosion ou un incendie.</b> 1.1 Ne pas couper près des matières inflammables. 1.2 Un extincteur doit être à proximité et prêt à être utilisé. 1.3 Ne pas utiliser un fût ou un autre contenant fermé comme table de coupage.
2		<b>2. Plasma arc can injure and burn; point the nozzle away from yourself. Arc starts instantly when triggered.</b> 2.1 Turn off power before disassembling torch. 2.2 Do not grip the workpiece near this cutting path. 2.3 Wear complete body protection.	<b>2. L'arc plasma peut blesser et brûler; éloigner la buse de soi. Il s'allume instantanément quand on l'amorce;</b> 2.1 Couper l'alimentation avant de démonter la torche. 2.2 Ne pas saisir la pièce à couper de la trajectoire de coupage. 2.3 Se protéger entièrement le corps.
3		<b>3. Hazardous voltage. Risk of electric shock or burn.</b> 3.1 Wear insulating gloves. Replace gloves when wet or damaged. 3.2 Protect from shock by insulating yourself from work and ground. 3.3 Disconnect power before servicing. Do not touch live parts.	<b>3. Tension dangereuse. Risque de choc électrique ou de brûlure.</b> 3.1 Porter des gants isolants. Remplacer les gants quand ils sont humides ou endommagés. 3.2 Se protéger contre les chocs en s'isolant de la pièce et de la terre. 3.3 Couper l'alimentation avant l'entretien. Ne pas toucher les pièces sous tension.
4		<b>4. Plasma fumes can be hazardous.</b> 4.1 Do not inhale fumes. 4.2 Use forced ventilation or local exhaust to remove the fumes. 4.3 Do not operate in closed spaces. Remove fumes with ventilation.	<b>4. Les fumées plasma peuvent être dangereuses.</b> 4.1 Ne pas inhaler les fumées 4.2 Utiliser une ventilation forcée ou un extracteur local pour dissiper les fumées. 4.3 Ne pas couper dans des espaces clos. Chasser les fumées par ventilation.
5		<b>5. Arc rays can burn eyes and injure skin.</b> 5.1 Wear correct and appropriate protective equipment to protect head, eyes, ears, hands, and body. Button shirt collar. Protect ears from noise. Use welding helmet with the correct shade of filter.	<b>5. Les rayons d'arc peuvent brûler les yeux et blesser la peau.</b> 5.1 Porter un bon équipement de protection pour se protéger la tête, les yeux, les oreilles, les mains et le corps. Boutonner le col de la chemise. Protéger les oreilles contre le bruit. Utiliser un masque de soudeur avec un filtre de nuance appropriée.
6		<b>6. Become trained.</b> Only qualified personnel should operate this equipment. Use torches specified in the manual. Keep non-qualified personnel and children away. <b>7. Do not remove, destroy, or cover this label.</b> Replace if it is missing, damaged, or worn (PN 110584 Rev C).	<b>6. Suivre une formation.</b> Seul le personnel qualifié a le droit de faire fonctionner cet équipement. Utiliser exclusivement les torches indiquées dans le manuel. Le personnel non qualifié et les enfants doivent se tenir à l'écart. <b>7. Ne pas enlever, détruire ni couvrir cette étiquette.</b> La remplacer si elle est absente, endommagée ou usée (PN 110584 Rev C).

- |  |   |
|--|---|
| <p>1. Las chispas producidas por el corte pueden causar explosiones o incendios.</p> <p>1.1 Mantenga los materiales inflamables lejos del lugar de corte.</p> <p>1.2 Tenga a mano un extinguidor de incendios y asegúrese de que alguien esté preparado para utilizarlo.</p> <p>1.3 No corte depósitos cerrados.</p> <p>2. El arco de plasma puede causar quemaduras y lesiones.</p> <p>2.1 Apague la fuente de energía antes de desarmar la antorcha.</p> <p>2.2 No sostenga el material junto al trayecto de corte.</p> <p>2.3 Proteja su cuerpo completamente.</p> <p>3. Los electrochoques provocados por la antorcha o el cableado pueden ser fatales. Protéjase del electrochoque.</p> <p>3.1 Colóquese guantes aislantes. No utilice guantes dañados o mojados.</p> <p>3.2 Aislese de la pieza de trabajo y de la tierra.</p> | <p>3.3 Antes de trabajar en una máquina, desconecte el enchufe de entrada o la potencia primaria.</p> <p>4. La inhalación de los humos provenientes del área de corte puede ser nociva para la salud.</p> <p>4.1 Mantenga la cabeza fuera de los gases tóxicos.</p> <p>4.2 Utilice ventilación forzada o un sistema local de escape para eliminar los humos.</p> <p>4.3 Utilice un ventilador para eliminar los humos.</p> <p>5. Los rayos del arco pueden producir quemaduras en los ojos y en la piel.</p> <p>5.1 Utilice un sombrero y gafas de seguridad. Utilice protección para los oídos y abróchese el botón del cuello de la camisa. Utilice un casco de soldar con el filtro de sombreado adecuado. Proteja su cuerpo completamente.</p> <p>6. Antes de trabajar en la máquina o de proceder a cortar, capacítese y lea las instrucciones completamente.</p> <p>7. No retire las etiquetas de advertencia ni las cubra con pintura.</p> |
|--|---|

## ETIQUETA DE ADVERTENCIA

Esta etiqueta de advertencia se encuentra adherida a la fuente de energía. Es importante que el operador y el técnico de mantenimiento comprendan el sentido de estos símbolos de advertencia según se describen. El texto numerado corresponde a los cuadros numerados de la etiqueta.



1. Las chispas producidas por el corte pueden causar explosiones o incendios.
  - 1.1 Mantenga los materiales inflamables lejos del lugar de corte.
  - 1.2 Tenga a mano un extinguidor de incendios y asegúrese de que alguien esté preparado para utilizarlo.
  - 1.3 No corte depósitos cerrados.
2. El arco de plasma puede causar quemaduras y lesiones.
  - 2.1 Apague la fuente de energía antes de desarmar la antorcha.
  - 2.2 No sostenga el material junto al trayecto de corte.
  - 2.3 Proteja su cuerpo completamente.
3. Los electrochoques provocados por la antorcha o el cableado pueden ser fatales. Protéjase del electrochoque.
  - 3.1 Colóquese guantes aislantes. No utilice guantes dañados o mojados.
  - 3.2 Aíslese de la pieza de trabajo y de la tierra.
  - 3.3 Antes de trabajar en una máquina, desconecte el enchufe de entrada o la potencia primaria.
4. La inhalación de los humos provenientes del área de corte puede ser nociva para la salud.
  - 4.1 Mantenga la cabeza fuera de los gases tóxicos.
  - 4.2 Utilice ventilación forzada o un sistema local de escape para eliminar los humos.
  - 4.3 Utilice un ventilador para eliminar los humos.
5. Los rayos del arco pueden producir quemaduras en los ojos y en la piel.
  - 5.1 Utilice un sombrero y gafas de seguridad. Utilice protección para los oídos y abróchese el botón del cuello de la camisa. Utilice un casco de soldar con el filtro de sombreado adecuado. Proteja su cuerpo completamente.
6. Antes de trabajar en la máquina o de proceder a cortar, capacítase y lea las instrucciones completamente.
7. No retire las etiquetas de advertencia ni las cubra con pintura.



## **INFORMACIÓN SOBRE LA COLECCIÓN DE POLVO SECO**

En algunos sitios, el polvo seco puede representar un peligro potencial de explosión.

La edición del 2007 de "U.S. National Fire Protection Association" iniciales en inglés NFPA (La Asociación Americana Nacional de Protección Contra Incendios) del estándar 68 "Protección de Explosión por medio de Respiradero de Deflagración" proporciona requisitos para el diseño, ubicación, instalación, mantenimiento, y uso de aparatos y sistemas para dar salida a gases de combustión y presiones después de todo evento de deflagración. Consulte con el fabricante o instalador de cualquier sistema de colección de polvo seco para los requisitos aplicables antes de que instale un sistema nuevo de colección de polvo seco, o haga cambios significativos en el proceso o materiales que se usen con un sistema existente de colección de polvo seco.

Consulte su "Autoridad que Tenga Jurisdicción" (iniciales en inglés AHJ) local para determinar si cualquier edición de la NFPA 68 ha sido "adoptada por referencia" en los códigos de construcción locales.

Remítase a la NFPA 68 para definiciones y explicaciones de los términos reguladores como "deflagración, AHJ, adoptada por referencia, el valor Kst, índice de deflagración" y otros términos.

Nota 1 – La interpretación de Hypertherm de estos nuevos requisitos es que, a no ser que se haya completado una evaluación específica del sitio para determinar que todo polvo generado no es combustible, la edición del 2007 de la NFPA 68 requiere el uso de respiraderos de explosión diseñados para el peor caso del valor Kst (vea anexo F) que pudiera ser generado por el polvo, de manera que el tamaño y tipo del respiradero de explosión pueda diseñarse. La NFPA 68 no identifica específicamente corte por plasma u otros procesos de cortes termales como si requirieran sistemas de respiraderos de deflagración, pero en realidad aplica estos nuevos requisitos a todos los sistemas de colección de polvos secos.

Nota 2 – Los usuarios de los manuales de Hypertherm deberían consultar y cumplir con todas las leyes y reglamentos federales, estatales y locales aplicables. Hypertherm, al publicar todo manual de Hypertherm, no intenta urgir acción que no esté en cumplimiento con todos los reglamentos y normas, y este manual nunca debe interpretarse como si lo hiciera así.



## Section 2

# SPECIFICATIONS

---

*In this section:*

Power supply .....	2-2
Duty cycle .....	2-3
Dimensions and weight .....	2-3
T100 torches .....	2-4
Torch dimensions.....	2-5
T100 hand torch .....	2-5
T100M-2 machine torch.....	2-5
Symbols and markings.....	2-6
[S] mark .....	2-6
CE mark .....	2-6
IEC symbols.....	2-6

## SPECIFICATIONS

### Power supply

Rated open circuit voltage ( $U_0$ )	300 VDC		
Output characteristic* *Defined as a plot of output voltage versus output current	Drooping		
Rated output current ( $I_2$ )	30A – 100A		
Hypertherm Standard Rated Output Voltage ( $U_2$ )	160 VDC		
Duty cycle ( $X^*$ ) at 104°F (40°C) at rated conditions ( $U_1, I_1, U_2, I_2$ )  * $X = T_{on}/T_{base}$ , $T_{on}$ = time, minutes $T_{base}$ = 10 minutes	$U_1$ – Volts AC rms	X	
	200-208 VAC 3PH	60%	
	230-240 VAC 3PH	70%	
	380-415 VAC 3PH	80%	
	480 VAC 3PH 600 VAC 3PH	80%	
Operating temperature	14° to 104° F (-10° to 40° C)		
Rated AC phases (PH) and line frequency (Hz) Standard and CE Model	PH	Hz	
	3	50-60	
Rated input voltage ( $U_1$ ), rated input current ( $I_1$ ) and $I_{1eff}$ * at rated output $U_2$ and $I_2$ – cutting only.  * $I_{1eff} = (I_1) \sqrt{X}$ used to determine rating of power cord.	$U_1$ – Volts AC rms	$I_1$ -Amps rms	$I_{1eff}$
	200-208 VAC 3PH	53	41
	230-240 VAC 3PH	46	38
	380-415 VAC 3PH	27	24
	480 VAC 3PH 600 VAC 3PH	22 21	20 19
Power factor	$U_1$ – Volts AC rms	Harmonic power factor	Displacement power factor
	200-208 VAC 3PH	0.94	0.98
	230-240 VAC 3PH	0.94	0.98
	380-415 VAC 3PH	0.94	0.99
	480 VAC 3PH 600 VAC 3PH	0.94 0.78	0.99 0.99
$R_{sce}$ – Short Circuit Ratio–CE model only	$U_1$ – Volts AC rms, 3PH	$R_{sce}$	
	400 VAC 230 VAC	191 142	
	<i>This equipment conforms to IEC 61000-3-12, provided that <math>R_{sce} \min = 191</math> at 400VAC 3PH and 142 at 230 VAC 3PH.</i>		
IP code–Degree of protection provided by enclosure	<p>IP23CS*</p> <p>IP – “International Protection”</p> <p>2 – No ingress foreign objects <math>\geq 12.5\text{mm}</math> (0.5 in)</p> <p>3 – No harmful ingress spraying water</p> <p>C – AC line circuits protected against ingress of tool <math>\geq 2.5</math> mm dia. x 100 mm long (0.1 inch x 4.0 inch)</p> <p>S – fan stationary during water test</p> <p><b>*WARNING: DO NOT OPERATE IN THE RAIN</b></p>		
Toppling, tilting (with or without wheel kit)	Up to 15° incline.		
Gas type	Air Nitrogen		
Gas quality	Clean, moisture-free, oil-free		
Gas inlet pressure and flow	90 psig (6.1 bar) 550 scfh/9.2 scfm (260 l/min)		

## Duty cycle

Duty cycle is the percentage of time, during a 10 minute period, that the power supply can cut continuously. The diagram below depicts an 80% duty cycle.

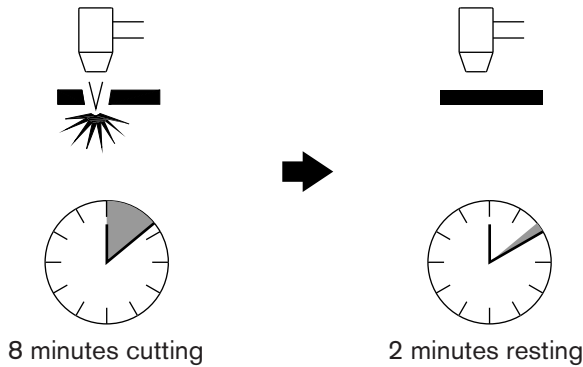

## Dimensions and weight

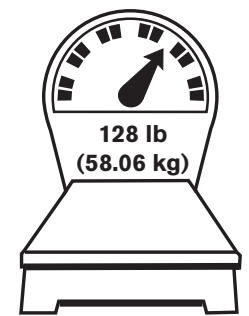

Weight of power supply  
without torch

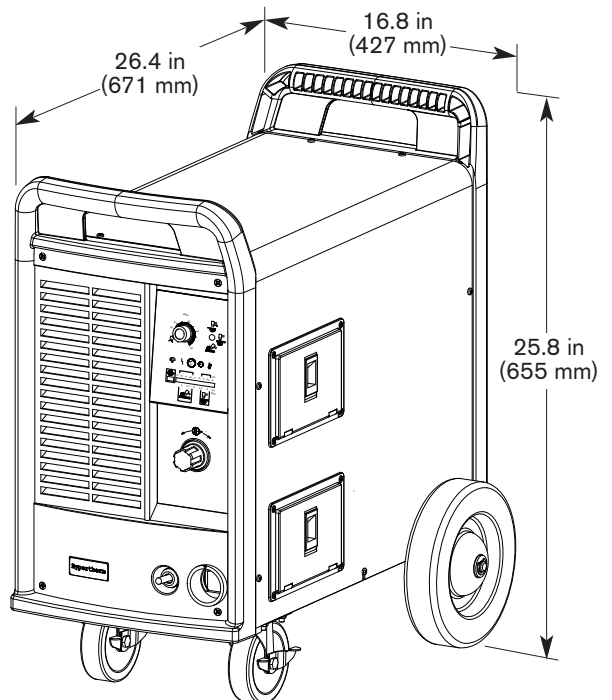

**T100 torches**

<b>Handheld cutting capacity at 100 amps</b>	
Recommended capacity	1-1/4 inch (32 mm) at 19 ipm (482 mm per min)
Maximum capacity	1-1/2 inch (38 mm) at 10 ipm (250 mm per min)
Severance capacity	1-3/4 inch (45 mm) at low speed
<b>Mechanized cutting capacity at 100 amps</b>	
Recommended pierce capacity	up to 1/2 inch (13 mm)
Maximum pierce capacity	3/4 inch (19 mm)
Severance with an edge start	1-3/4 inch (45 mm) at low speed
<b>Gouging capability</b>	
Metal removal rate on mild steel	24 pounds (10.8 kg) / hour
<b>Weight</b>	
T100	7.2 pounds (3.3 kg) with 25 ft (7.5 m) lead 13.9 pounds (6.3 kg) with 50 ft (15 m) lead 20.6 pounds (9.4 kg) with 75 ft (22.5 m) lead
T100M-2	8.3 pounds (3.8 kg) with 25 ft (7.5 m) lead 11.0 pounds (5.0 kg) with 35 ft (10.7 m) lead 15.0 pounds (6.8 kg) with 50 ft (15 m) lead 21.7 pounds (9.9 kg) with 75 ft (22.5 m) lead

## Torch dimensions

### T100 hand torch

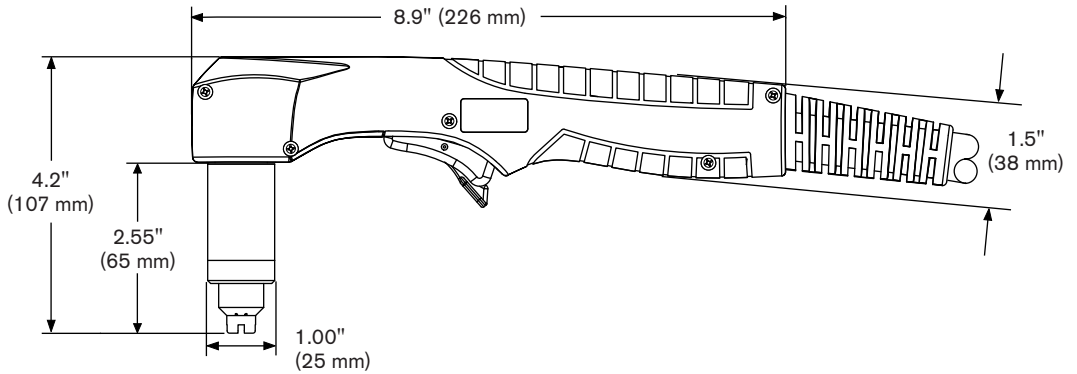

### T100M-2 machine torch

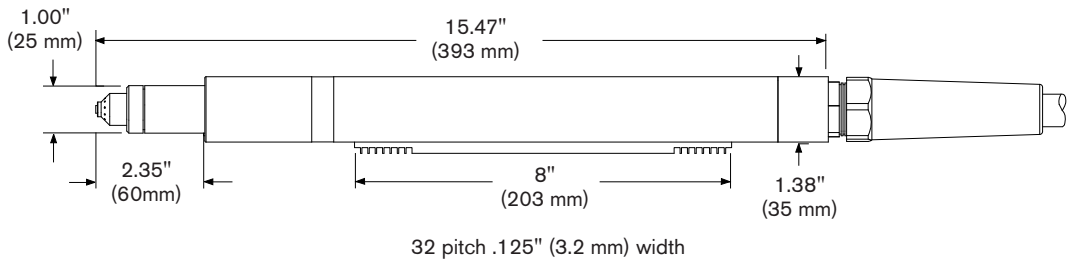

## Symbols and markings

### **S** mark







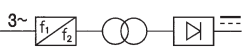

The **S** mark indicates that the power supply and torch are suitable for use in environments with increased hazard of electrical shock. The hand torches must have shielded consumable parts to maintain **S** mark compliance.

### **CE** mark

The CE mark (**CE**) constitutes a manufacturer's declaration of conformity to applicable European directives and standards. Only those versions of Hypertherm products with a CE mark located on or near the data plate have been tested for compliance with the European Low Voltage Directive and the European EMC Directive. EMC filters needed to comply with the European EMC Directive are incorporated within versions of the power supply with a CE mark.

### **IEC Symbols Used**

The following symbols may appear on the power supply data plate, control labels and switches.

	Direct current (DC)		An inverter-based power source
	Alternating current (AC)		Plasma torch in the TEST position (cooling and cutting gas exiting nozzle)
	Plasma torch cutting and gouging		Power is ON
	AC input power connection		Power is OFF
	The terminal for the external protective (earth) conductor		Volt/amp curve, "drooping" characteristic



## Section 3

### SETUP

---

*In this section:*

Upon receipt.....	3-2
Claims.....	3-2
Contents of box.....	3-2
Lifting the power supply.....	3-3
Locating the power supply.....	3-4
Power connection.....	3-4
Engine drives.....	3-5
Grounding.....	3-6
Power cords.....	3-6
Three-phase power cord and plug installation.....	3-7
Power cord installation.....	3-7
Torch installation.....	3-8
Plasma gas supply.....	3-10
Additional gas filtration.....	3-10
Gas supply installation.....	3-11
T100M-2 torch alignment.....	3-11
ON/OFF pendant connection.....	3-12
Machine interface connection.....	3-12
Arc voltage.....	3-13
Changing XFER (start machine motion) from dry contact closure to voltage signal.....	3-15

## Upon receipt

1. Check that all items on your order have been received. Contact your distributor if any items are missing or damaged.
2. If there is evidence of damage, refer to Claims, below. All communications regarding this equipment must include the model number and serial number located on the back of the power supply.
3. Read the *Safety* section of this manual before setting up and operating this Hypertherm system.

## Claims

Claims for damage during shipment: If your unit was damaged during shipment, you must file a claim with the carrier. Hypertherm will furnish you with a copy of the bill of lading upon request. If you need additional assistance, call the nearest Hypertherm office listed in the front of this manual.

Claims for defective or missing merchandise: If any component is missing or defective, contact your Hypertherm distributor. If you need additional assistance, call the nearest Hypertherm office listed in the front of this manual.

## Contents of the box

Check the items against the illustration.

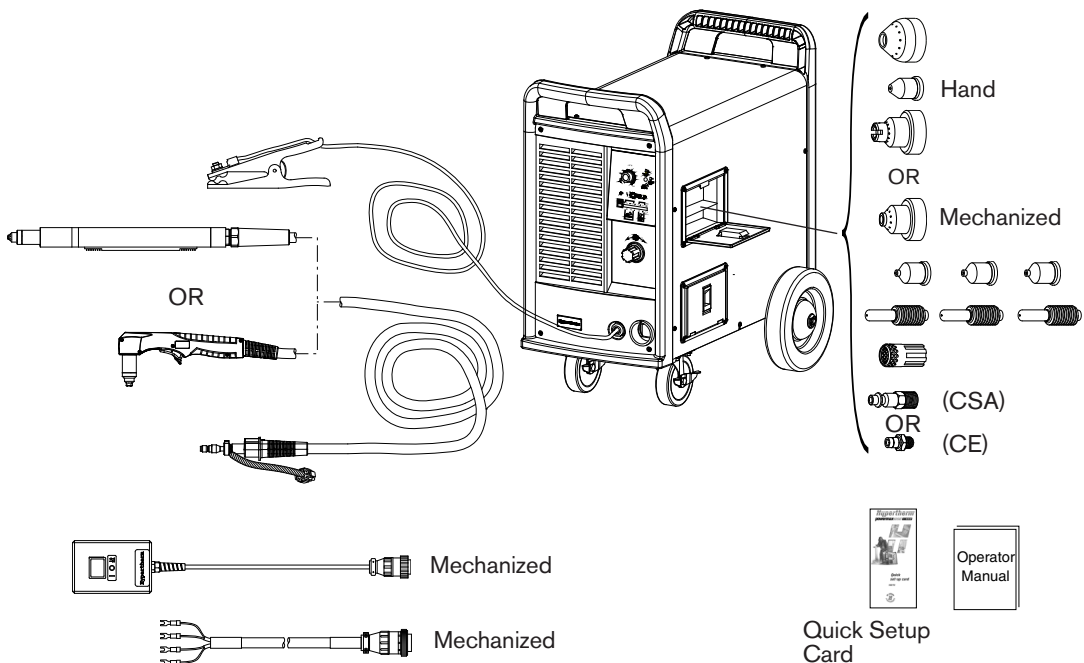

## Lifting the power supply

		<b>WARNING</b>
<ul style="list-style-type: none"> <li>• The system with torch weighs up to 150lb / 68 kg.</li> <li>• Always lift the power supply by <b>TWO</b> handles using two people or a hoist.</li> <li>• Do not lift the power supply by <b>ONE</b> handle.</li> <li>• The handle can break, resulting in injury and damage.</li> </ul>		

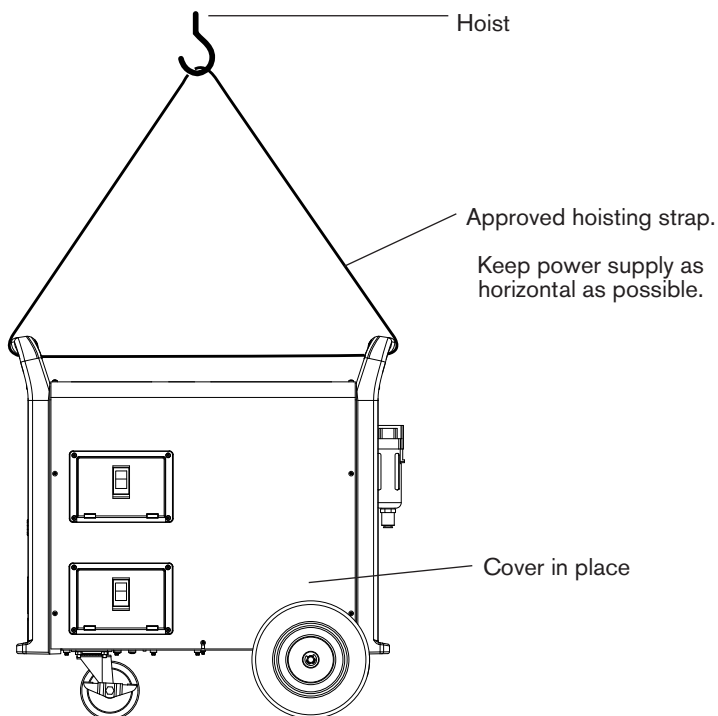
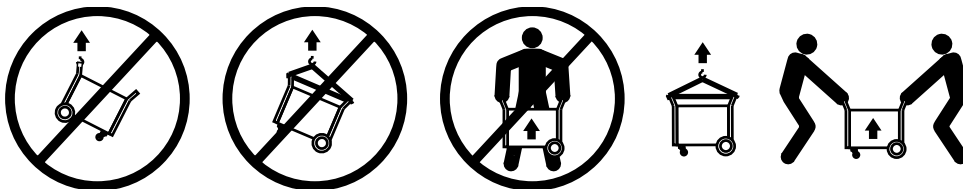

## Locating the power supply

Locate the Powermax1650 power supply with at least 10 inches (0.25 m) of open space at the front, back, and fan side of the power supply for proper ventilation.

## Power connection

The Powermax1650 is a universal power supply that configures itself to operate with AC voltages from 200 to 600 3PH (230-400 3PH for the CE model). Use a line disconnect switch for each power supply so that the operator can turn off the power supply quickly in an emergency. Locate the switch so it is easily accessible to the operator. The interrupt level of the switch must be equal to or exceed the continuous rating of the fuses. Use slow-blow fuses rated per local and national electrical codes.

<b>CSA model</b>	<b>Three-phase</b>				
Input voltage	200-208	230-240	400	480	600
Input current at 16kw output	53	46	27	22	21
Input current during arc stretch	75	72	42	34	33
Recommend fuse	80	80	50	40	40

<b>CE model</b>	<b>Three-phase</b>	
Input voltage	230	400
Input current at 16kw output	46	27
Input current during arc stretch	72	42
Recomended fuse	80	50

## Engine drives

When using an engine drive to power the Powermax1650:

- The engine drive must be dedicated to powering the plasma cutting system.
- Engine drive operation:
  1. Set the engine drive output to 3 phase-AC.
  2. Plug the Powermax1650 power cord into the power outlet.
  3. Set the engine drive to the maximum output (see table below).
- Use unshielded consumables if you experience difficulty cutting thicker material (CSA power supplies only).

### CSA power supplies

3-Phase, 50/60 hz, 200 – 600 VAC (480 VAC recommended for best performance)

### CE power supplies

3-Phase, 50/60 hz, 230 – 400 VAC (400 VAC recommended for best performance)

Engine drive rating	Powermax1650 output current	Performance
30 kw	100 A	Full arc stretch
22.5 kw	100 A 80 A	Limited arc stretch Full arc stretch
15 kw	80 A 60 A	Limited arc stretch Full arc stretch

## Grounding

To ensure personal safety and proper operation, and to reduce electromagnetic interference (EMI), the Powermax1650 must be properly grounded through the power cord according to local and national electrical codes. Three-phase service must be of the 4-wire type with a green or green/yellow wire for protective earth ground and must comply with local and national electrical requirements. Refer to Section 1, Grounding Safety.

## Power cords

Use a cord that is certified by local and national codes. The cord should be installed by a licensed electrician. Refer to the length requirements listed below.

		<b>Recommended extension cord gauge size AWG (mm<sup>2</sup>)</b>									
		<b>&lt; 10 ft &lt; 3 m</b>		<b>10-25 ft 3 – 7.5 m</b>		<b>25-50 ft 7.5 – 15 m</b>		<b>50-100 ft 15 – 30 m</b>		<b>100-150 ft 30 – 45 m</b>	
<b>CSA model</b>											
<b>Input voltage</b>	<b>Phase</b>	<b>AWG</b>	<b>mm<sup>2</sup></b>	<b>AWG</b>	<b>mm<sup>2</sup></b>	<b>AWG</b>	<b>mm<sup>2</sup></b>	<b>AWG</b>	<b>mm<sup>2</sup></b>	<b>AWG</b>	<b>mm<sup>2</sup></b>
200-208 VAC	3	6	(16)	6	(16)	6	(16)	4	(25)	2	(35)
230 VAC	3	6	(16)	6	(16)	6	(16)	4	(25)	2	(35)
400 VAC	3	8	(10)	8	(10)	8	(10)	8	(10)	8	(10)
480 VAC	3	10	(6)	10	(6)	10	(6)	10	(6)	10	(6)
600 VAC	3	10	(6)	10	(6)	10	(6)	10	(6)	10	(6)
<b>CE model</b>											
<b>Input voltage</b>	<b>Phase</b>	<b>mm<sup>2</sup></b>		<b>mm<sup>2</sup></b>		<b>mm<sup>2</sup></b>		<b>mm<sup>2</sup></b>		<b>mm<sup>2</sup></b>	
230 VAC	3	16		16		16		25		35	
400 VAC	3	10		10		10		10		10	

Note: The unit was tested with a 2 m power cord to verify EMC standard EN50199 compliance.

## Three-phase power cord and plug installation

The Powermax1650 power supplies are shipped with a 6 AWG 4-wire UL/CSA power cord on CSA units. A 10 mm<sup>2</sup>, 4-wire HAR power cord is provided on CE units. To operate the Powermax1650, use a plug that meets national or local electrical codes. The plug must be connected to the power cord by a licensed electrician.

### Power cord installation

1. Strip and prepare the power cord wires as shown below:

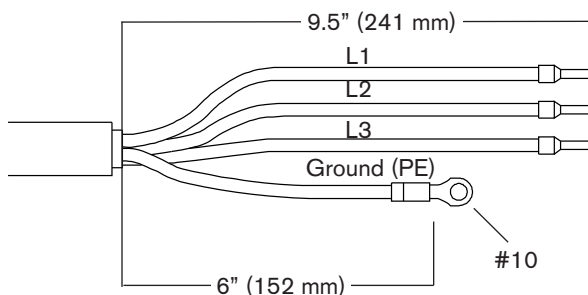

	CSA	CE
L1	Black	Black (U)
L2	White	Blue (V)
L3	Red	Brown (W)
Ground (PE)	Green	Green/Yellow

2. Connect the power cord to the power switch.

Note: On CE power supplies, L1, L2, and L3 are threaded through 2 ferrites before being attached at the switch.

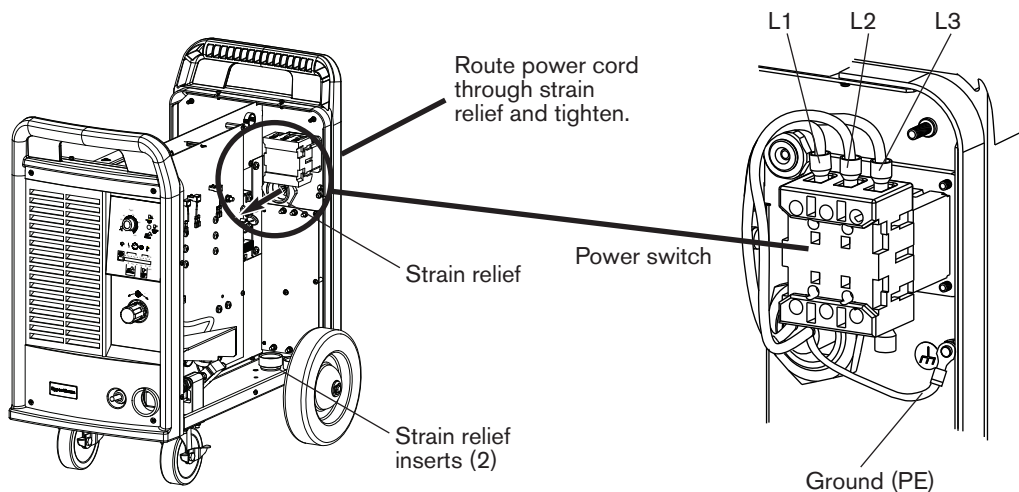

## Torch installation

1. Turn OFF the power.

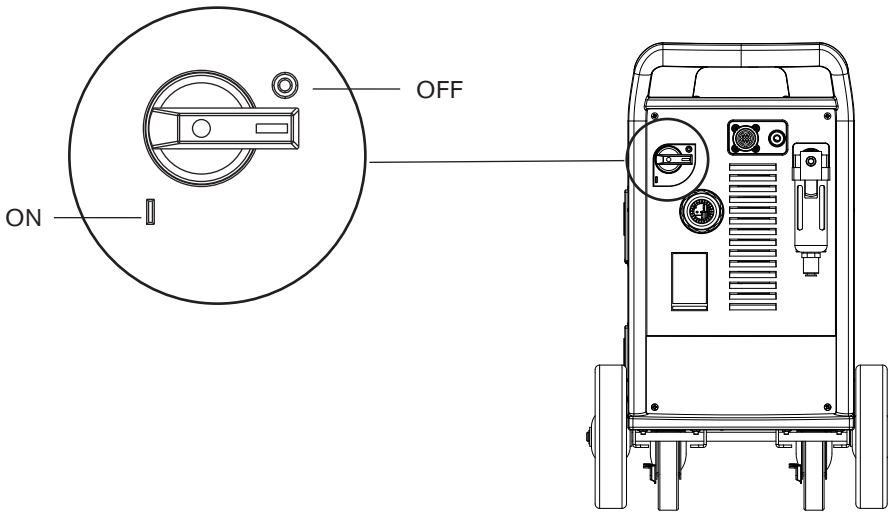

2. Remove the power cord from the power receptacle.

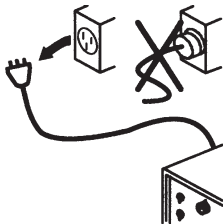

3. Open the Easy Torch Removal (ETR) door and route the lead through the end cap.

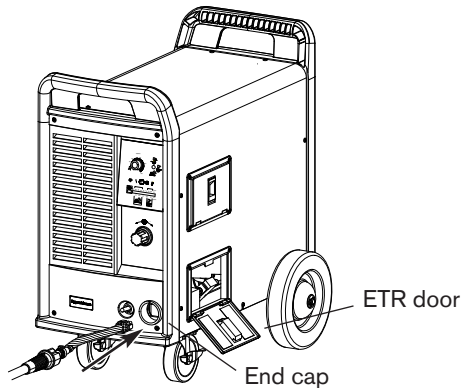



4. Align the marks on the strain relief.

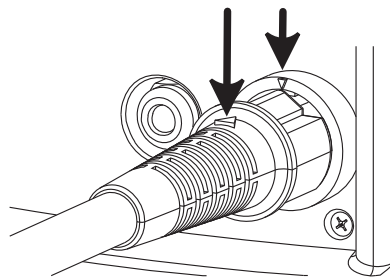

5. Pull back the quick-release collar and insert the lead's gas fitting.

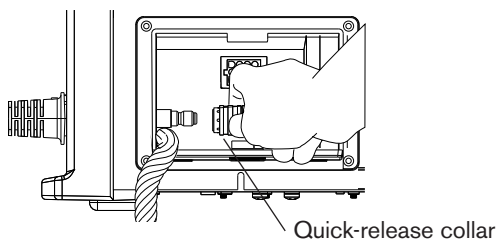

6. Slide the quick-release collar forward to lock the gas fitting in place. Make sure that the gas fitting is secure.

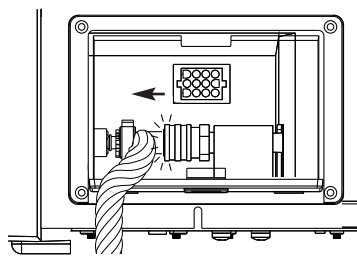

7. Make sure that the red dot on the connector is on top, then plug in the electrical connector.

Close the ETR door.

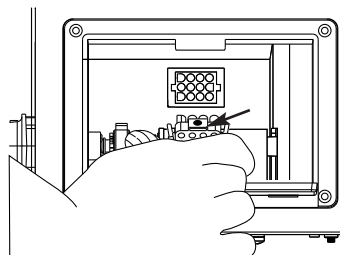

## Plasma gas supply

The gas supply for the Powermax1650 can be shop-compressed air or cylinder-compressed air. A high-pressure regulator must be used on either type of supply and must be capable of delivering gas to the filter on the power supply at 550 scfh/9.2 scfm (260 l/min), minimum flow rate, at a minimum pressure of 90 psig (6.1 bar).

Note: If the gas supply quality is poor, cut speeds decrease, cut quality deteriorates, cutting thickness capability decreases, and parts life shortens.



### **WARNING**

**Do not allow the gas supply pressure to exceed 120 psi (8.3 bar). The filter bowl may explode if this pressure is exceeded.**

## Additional gas filtration

Use Hypertherm filter kit (part number 128647) when site conditions introduce moisture, oil or other particulates into the air line. A 3-stage coalescing filtration system, as shown, should be used in extreme conditions.

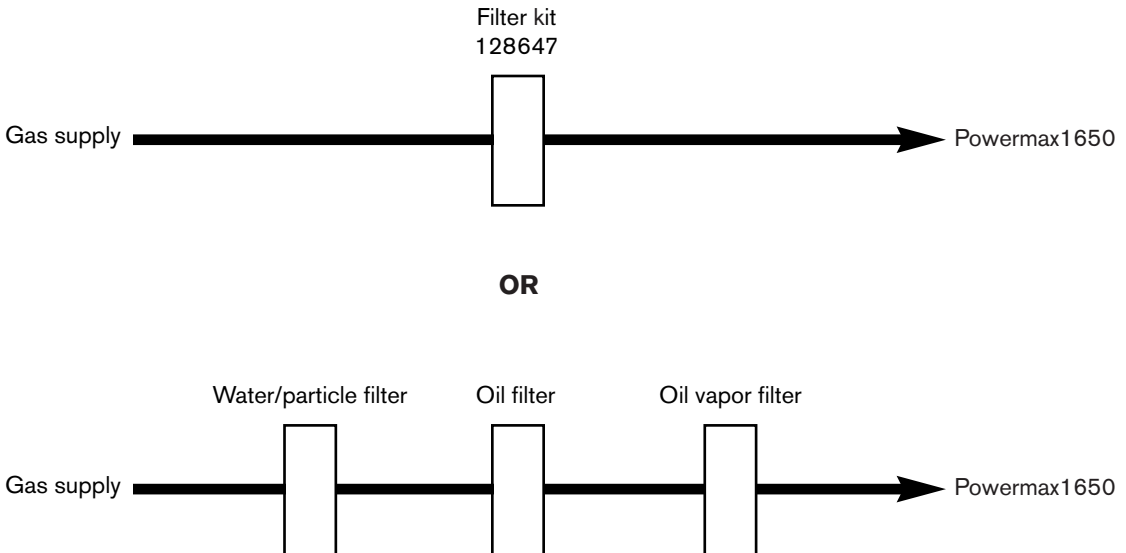

## Gas supply installation

Connect the air hose as follows:

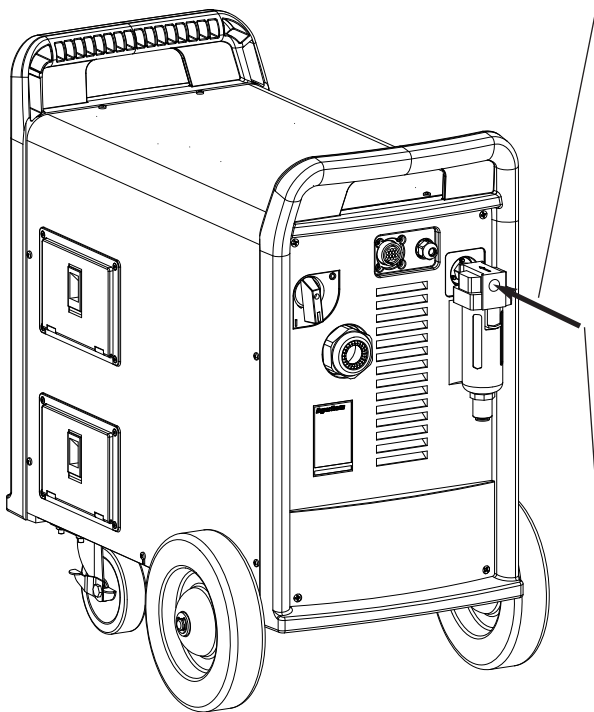

### 1. Air fitting

- For the standard model: Install a 1/4 NPT gas fitting on to the air filter inlet. The CE model provides a G1/4 adapter in the CE kit. Use liquid pipe sealant on the threads.

**CAUTION: Never use Teflon tape when installing the nipple or adapters. Bits of tape can break off and enter the air line and harm the pressure regulator, pressure switch, and valve.**

- Nipple/Adapter is found in the consumables box, located on the side of the power supply cover.

### 2. Air hose

- Use an inert gas hose with a 3/8 inch (9.5 mm) internal diameter. Connect it to the gas fitting installed in step 1.

Adjust the air pressure according to the procedure in Section 4, *Operation*.

## T100M-2 torch alignment

Mount the machine torch perpendicular to the workpiece in order to get a vertical cut. Use a square to align the torch at 0° and 90°.

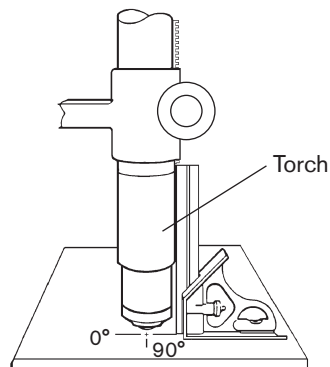

## ON/OFF pendant connection

For the machine torch (T100), inputs for arc start are available through the machine interface connection on the rear of the power supply. Plug the Hypertherm remote pendant (see Section 5, *Maintenance and parts*, for part numbers) into the connector on the rear panel.

	<h3 style="margin: 0;">WARNING</h3>
<p><b>The ON/OFF remote pendant will not operate when a hand torch is installed.</b></p>	

## Machine interface connection



Signals for arc transfer and start are available through the machine interface connection on the rear of the power supply. Plug the machine interface cable (Part number 023206) into the connector on the rear panel.

Powermax1650 power supplies sold as part of the PowermaxEdge® package include a machine interface cable with a voltage divider.

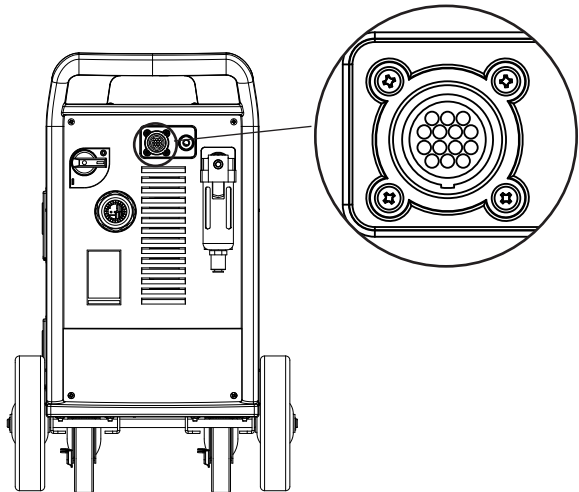
Refer to the following table when connecting the machine interface cable to the cutting machine.

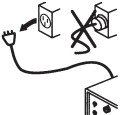

Signal	Start (start plasma)	XFER (start machine motion)
Type:	Input	Output
Notes:	Normally open, 18VDC open circuit voltage at START terminals. REquires dry contact closure to activate.	Normally open. Dry contact closure when the arc transfers. 120VAC/1A maximum at the machine interface relay or switching device (supplied by the customer).
Rear panel sockets	3, 4	12, 14
Cable wires	Green, black	Red, black

		<p><b>WARNING</b> <b>ELECTRIC SHOCK CAN KILL</b></p>
	<p><b>Disconnect electrical power before performing any maintenance. All work requiring removal of the power supply cover must be performed by a qualified technician.</b></p>	

## Arc voltage

If arc voltage is necessary for activating a torch height control, the customer must supply an 18 AWG (1.0 mm<sup>2</sup>), single pair, unshielded cable rated for 300V or greater. All work must be performed following applicable local and national codes.

1. Disconnect the power from the power supply.
2. Remove the screws that attach the power supply cover to the chassis. Remove the cover.
3. Route the cable through the strain relief at the rear of the power supply.

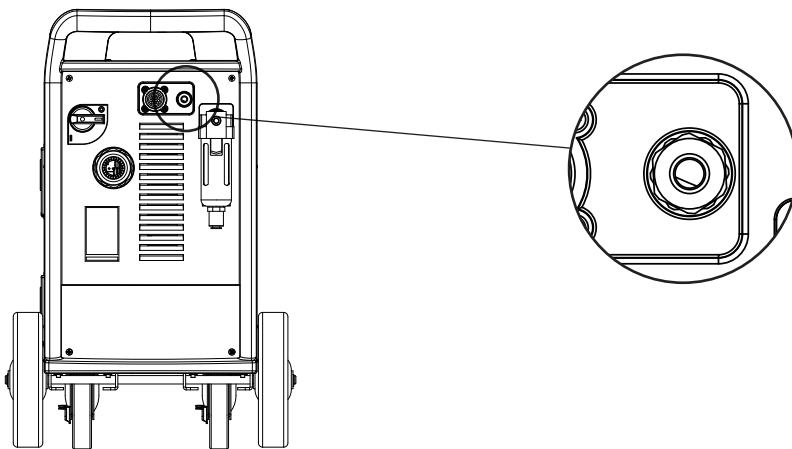

## SETUP

---

4. Find the power board. Use insulated type 1/4-inch faston terminal ends to connect to J15 and J16.

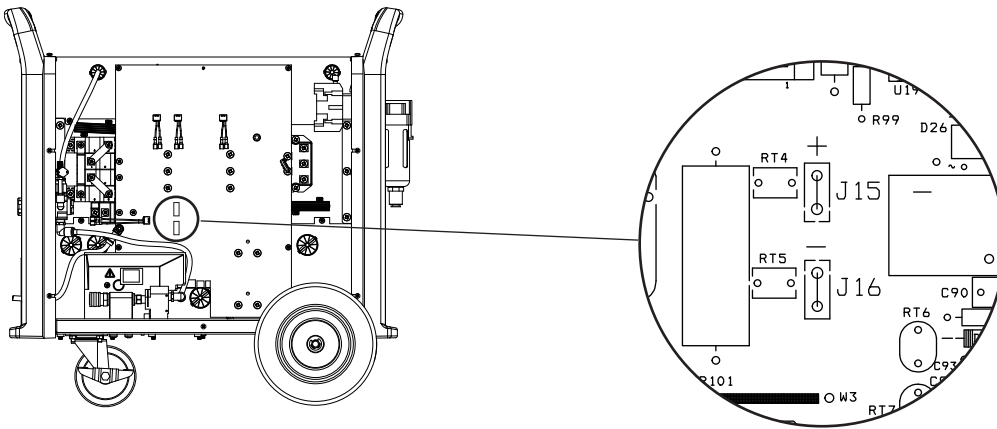

Signal: Arc voltage (torch height control)

Type: Output

Notes: Full arc voltage. No voltage divider. 300 VDC maximum. (Signal not available on rear panel connector.)

J15 +VDC

J16 -VDC

5. Tighten the strain relief.
6. Replace the cover

## Changing XFER (start machine motion) from dry contact closure to voltage signal

24 VDC (chassis ground reference) at 100ma max is available at J19 on the powerboard to drive an isolated/floating device such as a 24 VDC relay coil (240 ohms or greater) or a typical industrial isolated input module (which has an opto-coupler built-in). Shown below are typical connections for a high-side drive arrangement.

### Driving a relay coil

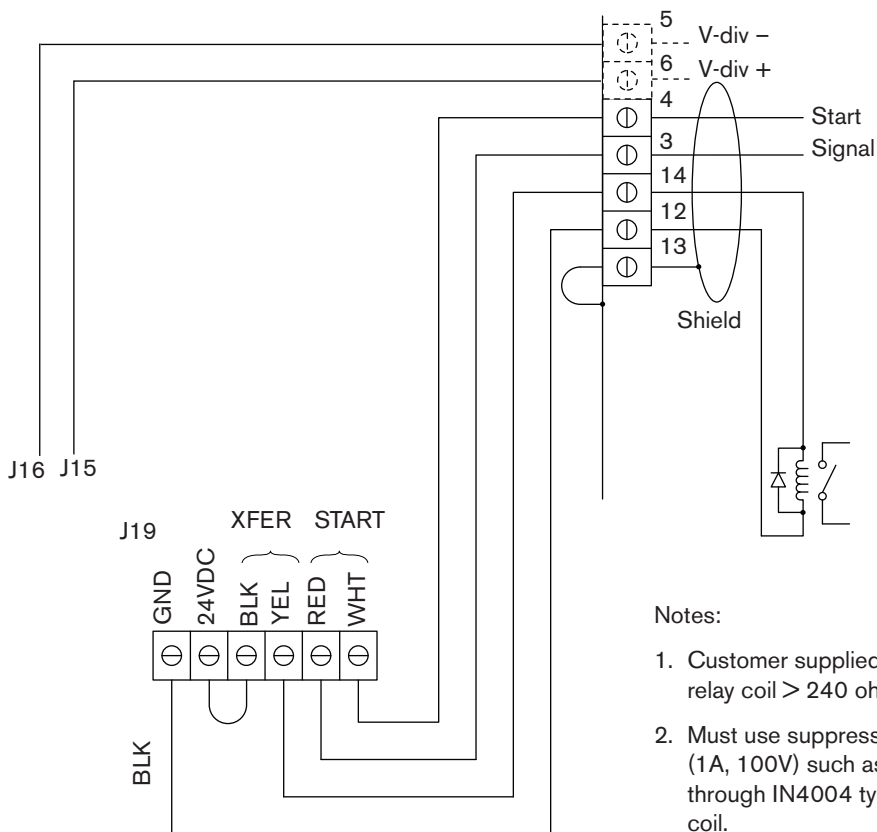

Move the black (BLK) wire to ground (GND) and add a jumper wire as shown.

#### Notes:

1. Customer supplied 24 VDC relay coil > 240 ohms.
2. Must use suppression diode (1A, 100V) such as IN4002 through IN4004 type across coil.
3. Pins 5 and 6 are used only on systems that include the PowermaxEDGE cable with voltage divider.

**Driving an industrial isolated input module**

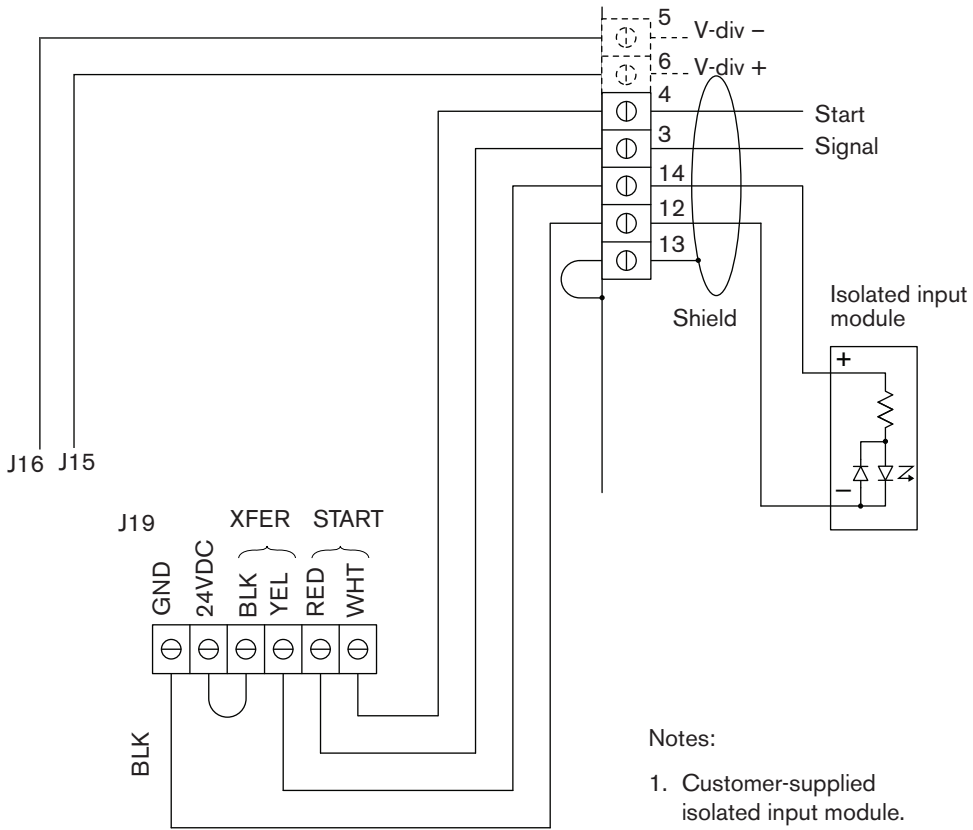

Move the black (BLK) wire to ground (GND) and add a jumper wire as shown.

- Notes:
1. Customer-supplied isolated input module.
  2. Pins 5 and 6 are used only on systems that include the PowermaxEDGE cable with voltage divider.





**Driving an industrial isolated input module with an external power source**

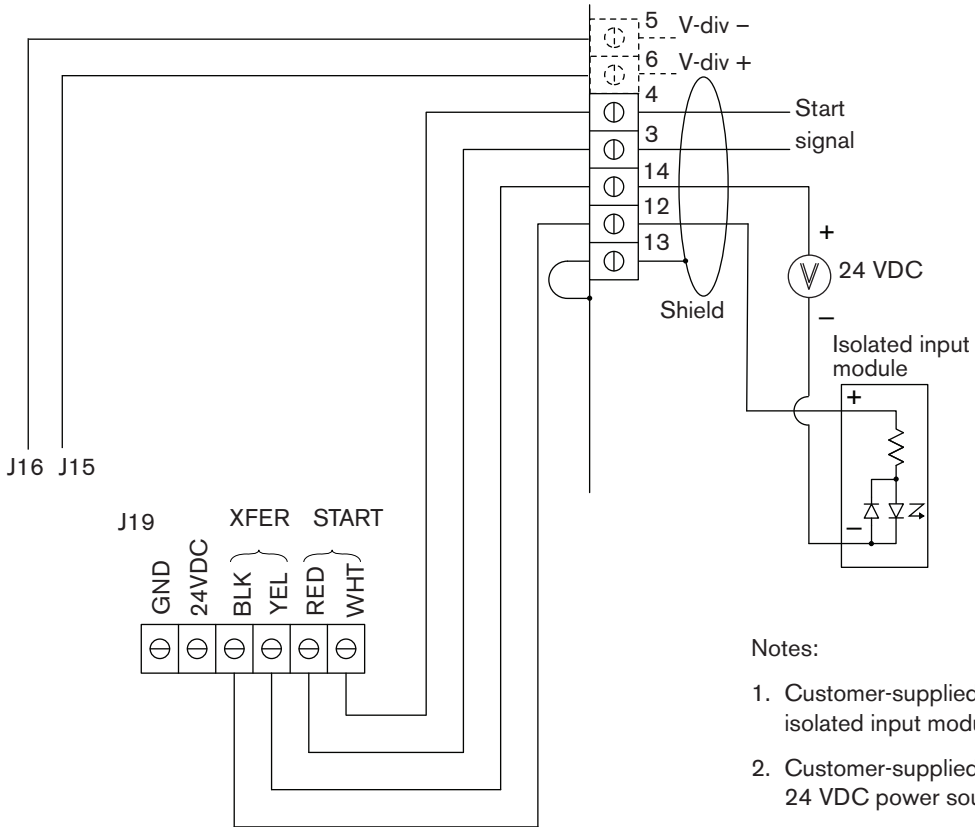

**Notes:**

1. Customer-supplied isolated input module.
2. Customer-supplied 24 VDC power source.
3. Pins 5 and 6 are used only on systems that include the PowermaxEDGE cable with voltage divider.

## Section 4

### OPERATION

---

*In this section:*

Controls and indicators .....	4-2
Indicator LEDs.....	4-2
Install the consumables .....	4-3
T100 consumable configurations.....	4-4
Shielded.....	4-4
Unshielded .....	4-4
FineCut.....	4-4
Gouging .....	4-5
T100M-2 consumable configurations .....	4-5
Shielded.....	4-5
FineCut.....	4-6
Ohmic sensing retaining caps.....	4-6
Unshielded .....	4-6
Set the mode switch.....	4-7
Turn ON the power .....	4-7
Check the indicator lights.....	4-7
Adjust the gas pressure and current setting .....	4-8
Hand torch operation .....	4-9
Safety trigger operation .....	4-9
Attach the work clamp .....	4-10
Start a cut from the edge of the workpiece .....	4-10
Hand torch cutting technique.....	4-11
Piercing .....	4-12
Gouging .....	4-13
Cut charts.....	4-14

## Controls and indicators

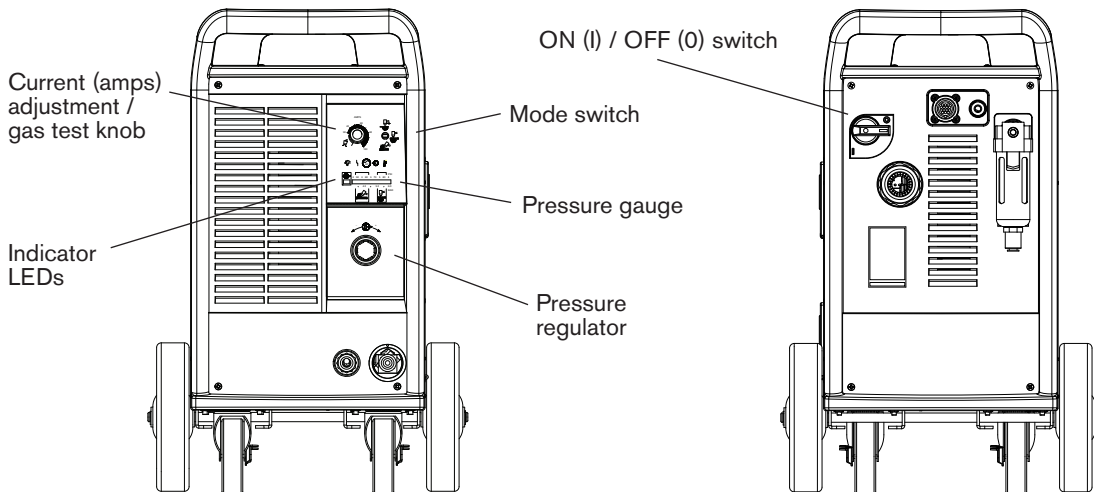

### Indicator LEDs



**Green power ON LED**

When illuminated, indicates that power is applied to the system and the power switch is ON (I).



**Gas pressure LED**

**Yellow:** When flashing, indicates that the gas pressure is below 65 psig (4.5 bar) for cutting, or 40 psig (2.8 bar) for gouging.

**Green:** When illuminated, indicates that there is acceptable gas pressure for torch operation.



**Yellow torch cap LED**

When illuminated, indicates that the retaining cap is loose or not installed.

**NOTE:** This condition must be corrected and the power turned OFF and then ON again to clear the LED.



**Yellow temperature LED**

When illuminated, indicates that the power supply temperature has exceeded its operating limit.



**Red fault LED**

When illuminated, indicates that a fault condition exists, which prevents system operation. A yellow LED should also be illuminated to identify the type of fault.



**Yellow line voltage LED**

When illuminated, indicates that line voltage is below 170 VAC, above 680 VAC, or missing a phase.

## Install the consumables

		<p><b>WARNING</b>  <b>Instant-On Torches</b>  <b>PLASMA ARC CAN CAUSE INJURY AND BURNS</b></p>
	<p>The plasma arc comes on immediately when the torch switch is activated. The plasma arc will quickly burn through gloves and skin. Make sure the power is OFF before changing the consumables.</p>	

The instructions for hand torches are shown below. If you are using a machine torch, you may need to install it on the cutting table prior to installing the consumables.

①

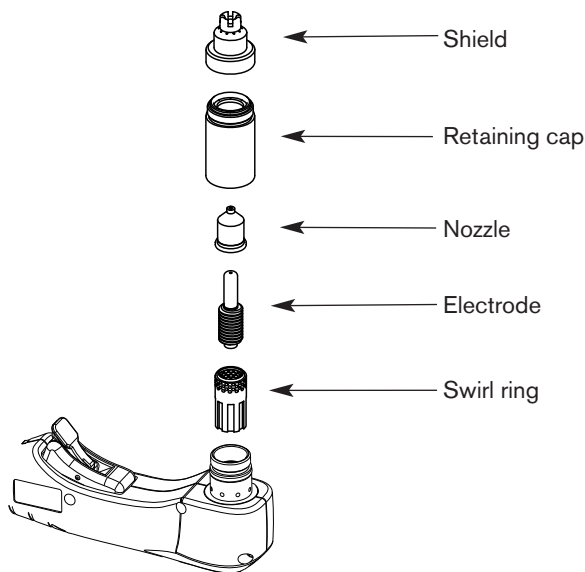

②

Note: Hand tighten only.

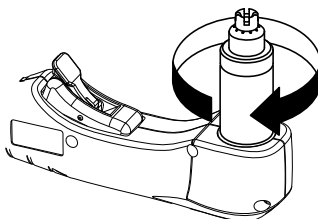

# T100 consumable configurations

## Shielded

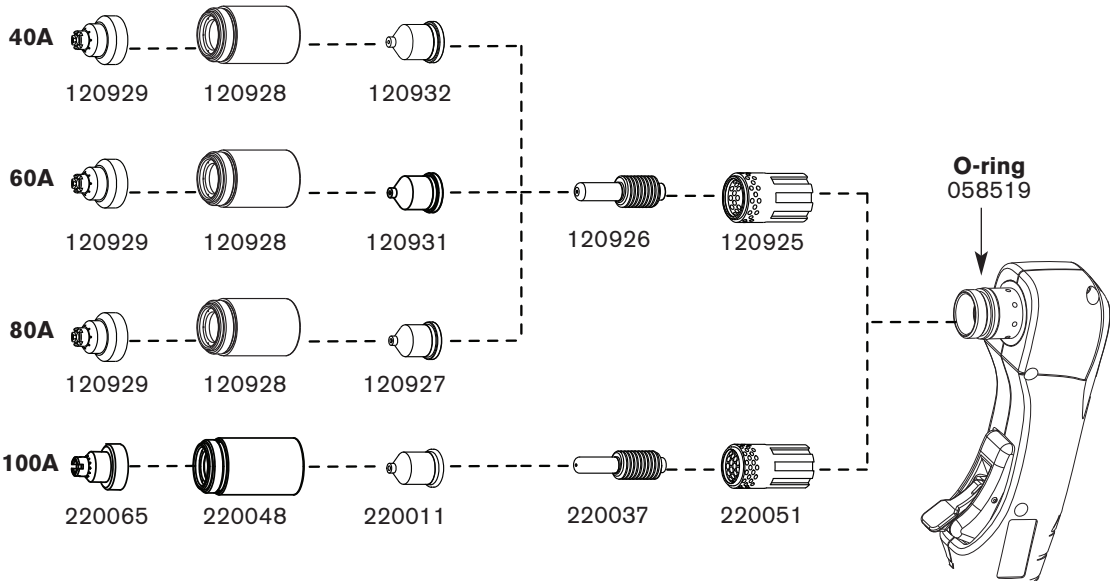

## Unshielded

The unshielded consumables available for the T100 hand torch (only for use with non-CE systems) are the same as those used for the T100M-2. See the illustrations later in this section.

## FineCut

### 30A – 50A

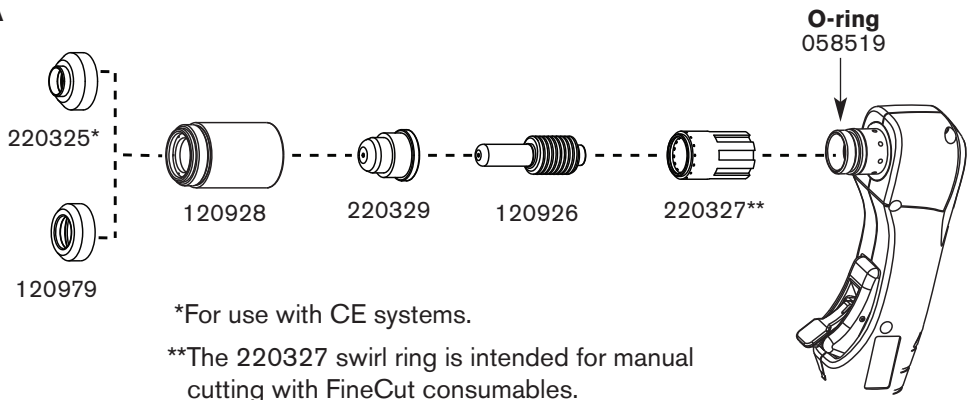

\*For use with CE systems.

\*\*The 220327 swirl ring is intended for manual cutting with FineCut consumables.

## Gouging

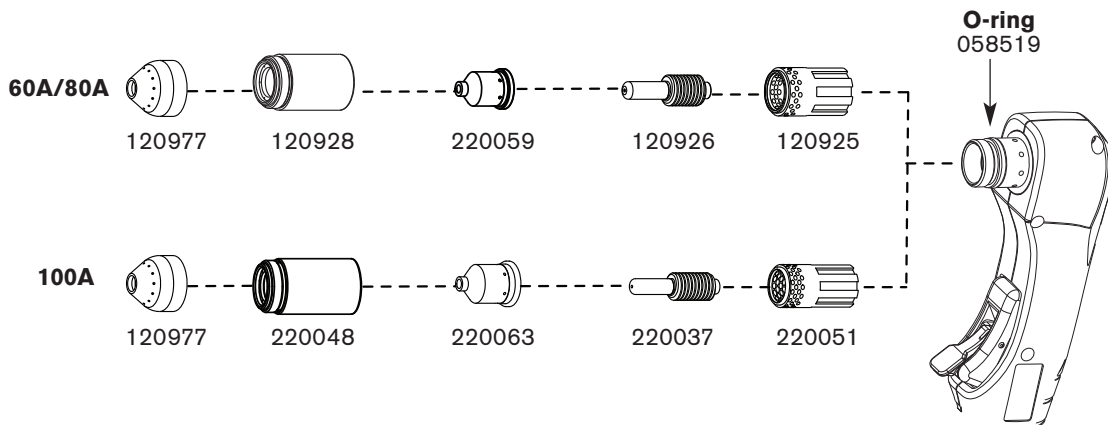

## T100M-2 consumable configurations

### Shielded

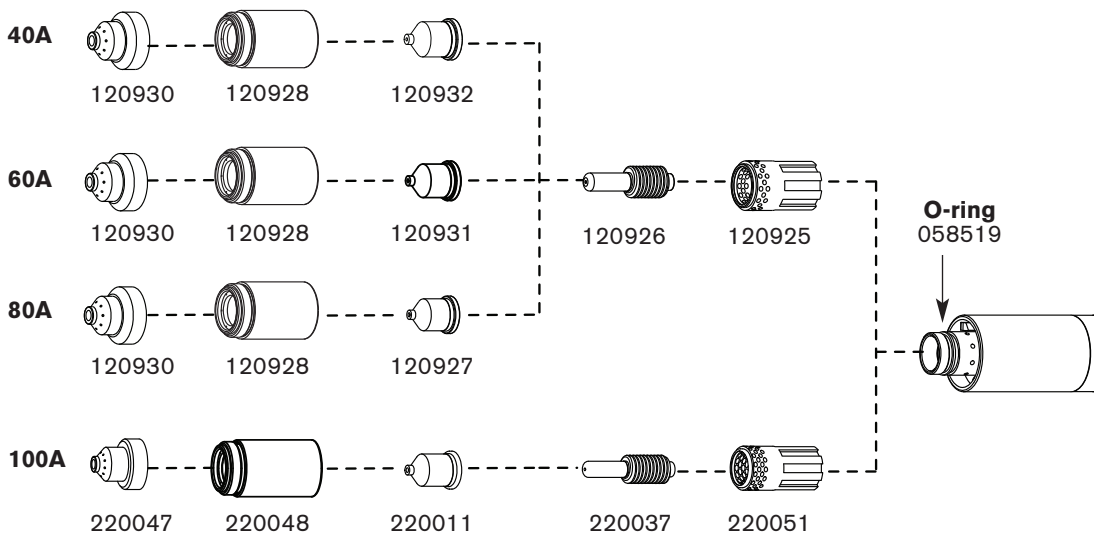

**FineCut**

**30A – 50A**

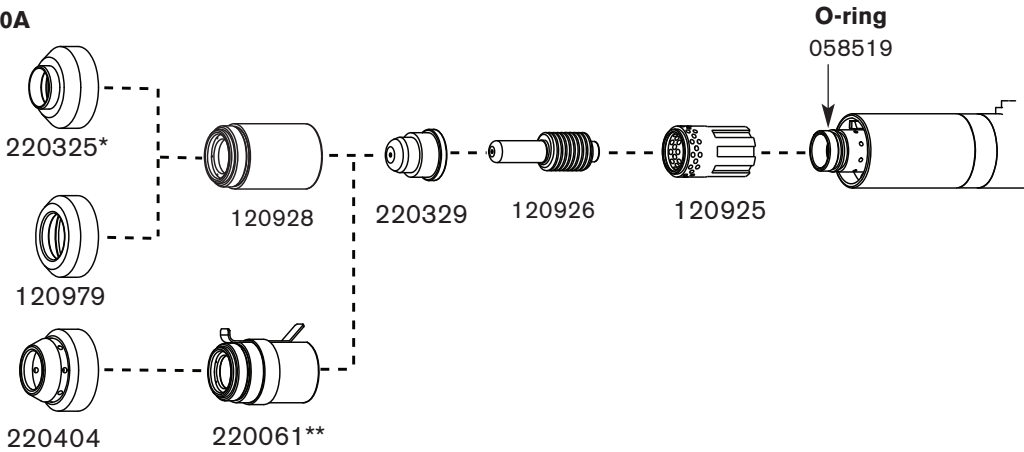

**Ohmic sensing retaining caps\*\***

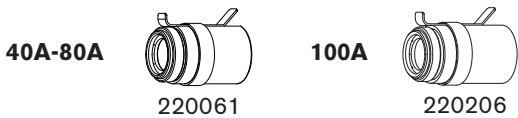

\* In CE countries, unshielded consumables may only be used in mechanized torch applications.

Maintain a torch-to-work distance of approximately 1/8 inch (3mm).

\*\* Use an ohmic sensing cap when a compatible torch height controller is installed.

**Unshielded\***

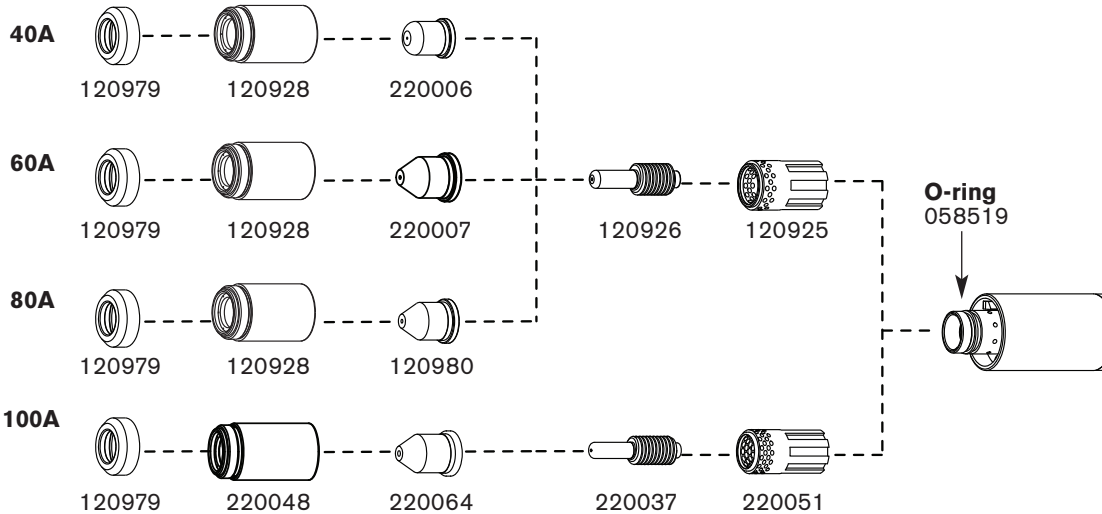



## Set the mode switch

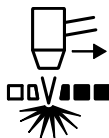

Use to cut expanded metal.  
Automatically reinitiates pilot.

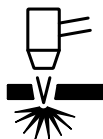

Use to cut plate/sheet metal.  
Optimum consumable life.



Use to gouge, or for non-transferred-arc operation.

## Turn ON the power

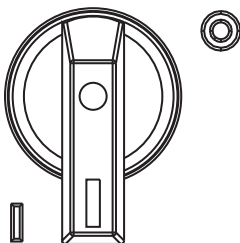

Position the power switch to ON ( I ) as shown.

Note: The cooling fan is automatic and will only operate when needed.

## Check the indicator lights



Check that the power ON lamp is illuminated.



Check that the gas pressure LED illuminates green.

Check that the remaining indicator lamps are NOT illuminated. See Section 5, *Maintenance and parts*, for details.



## Adjust the gas pressure and current setting

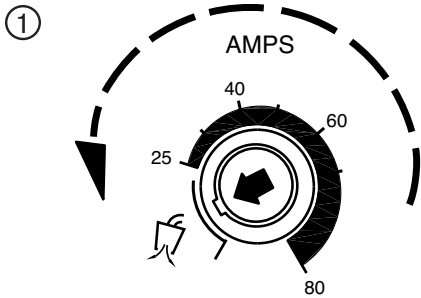

Set the current knob to gas test.

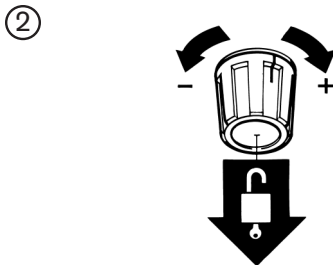

Pull the regulator knob to unlock it.

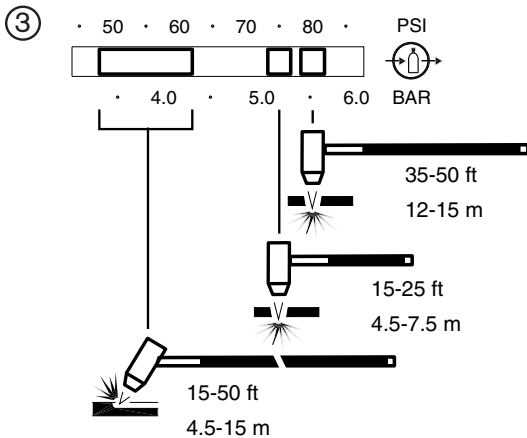

Set the pressure as shown above based on the cutting mode and torch lead length.

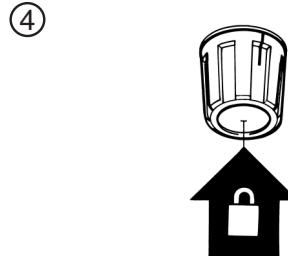

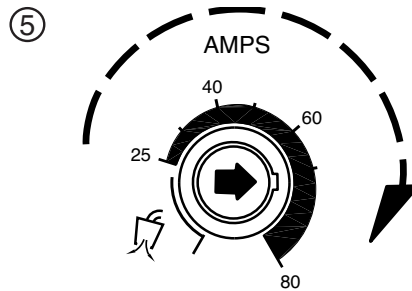

Push the regulator knob to lock it.



Set the cutting current (30 amps minimum).

## Hand torch operation

		<b>WARNING</b> Instant-On Torches <b>PLASMA ARC CAN CAUSE INJURY AND BURNS</b>
<p>The plasma arc comes on immediately when the torch switch is activated. The plasma arc will quickly burn through gloves and skin.</p> <ul style="list-style-type: none"><li>• Keep away from the torch tip.</li><li>• Do not hold the workpiece, and keep your hands clear of the cutting path.</li><li>• Never point the torch toward yourself or others.</li><li>• Never use with the pendant switch.</li></ul>		

## Safety trigger operation

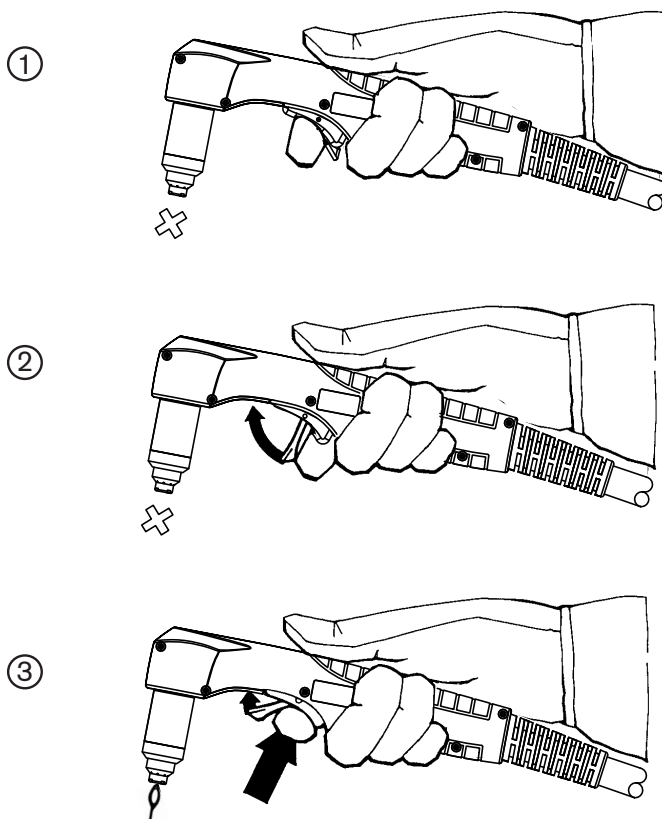

	<p><b>WARNING</b> <b>SPARKS AND HOT METAL CAN INJURE EYES AND BURN SKIN</b></p>
<p><b>When firing the torch at an angle, sparks and hot metal will spray out from the nozzle. Point the torch away from yourself and others.</b></p>	

**Attach the work clamp**

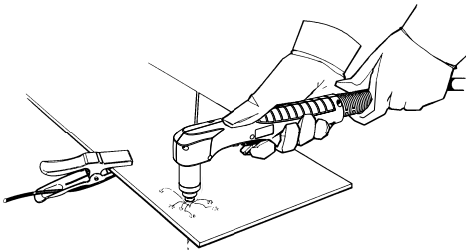

Attach the work clamp securely to the workpiece. Remove rust, paint or other coatings to ensure good electrical contact.

Attach the work clamp as close as possible to the area being cut, to reduce exposure to electromagnetic fields (EMF).

Do not attach the work clamp to the portion that will fall away.



**Start a cut from the edge of the workpiece**

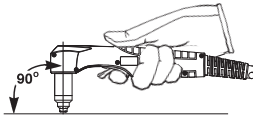

Hold the torch vertical at the edge of the workpiece.

Start cutting from the edge of the workpiece.

Pause at the edge until the arc has completely cut through the workpiece.

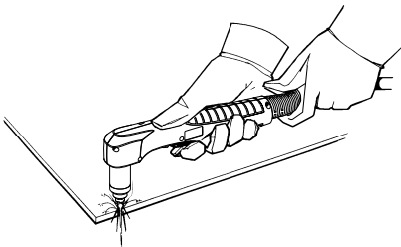

Then, proceed with the cut.

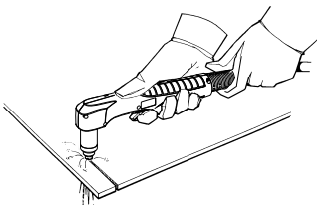

## Hand torch cutting technique

Firing the torch unnecessarily reduces nozzle and electrode life.



When cutting, make sure that sparks are exiting from the bottom of the workpiece.

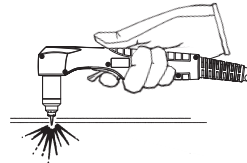

If sparks are spraying up from the workpiece, you are moving the torch too fast, or without sufficient power.

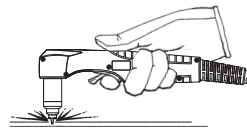

Hold the torch vertically and watch the arc as it cuts along the line.

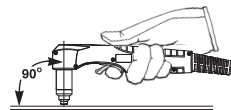

**Unshielded consumables:** Maintain a torch-to-work distance of approximately 3/16 in (4.8 mm).

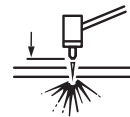

**Shielded consumables:** Do not push down on the torch when cutting. Drag the torch lightly across the workpiece to maintain a steady cut.



- It is easier to pull the torch through the cut than to push it.
- To cut thin material, reduce the amps until you get the best quality cut.
- For straight-line cuts, use a straight edge as a guide. To cut circles, use a template or the Hypertherm plasma cutting guide (part number 027668).
- Postflow – After the torch trigger switch is released, the gas will continue to flow for 30 seconds to cool the torch and consumables.

Note: The torch will restart if you activate the trigger switch during the postflow. To stop the postflow, activate and quickly release the torch trigger.

## OPERATION

### Piercing

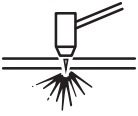

		<b>WARNING</b> <b>SPARKS AND HOT METAL CAN INJURE EYES AND BURN SKIN</b>
<b>When firing the torch at an angle, sparks and hot metal will spray out from the nozzle. Point the torch away from yourself and others.</b>		

Hold the torch so that the nozzle is within 1/8 in (3 mm) from the workpiece before firing the torch.

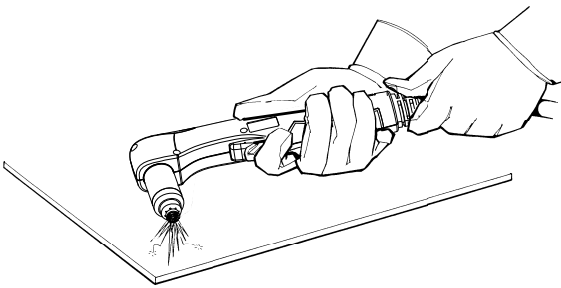

Fire the torch at an angle to the workpiece, then slowly rotate it to an upright position.

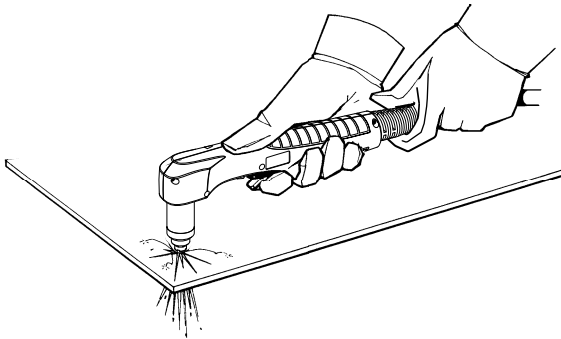

When sparks are exiting from the bottom of the workpiece, the arc has pierced through the material.

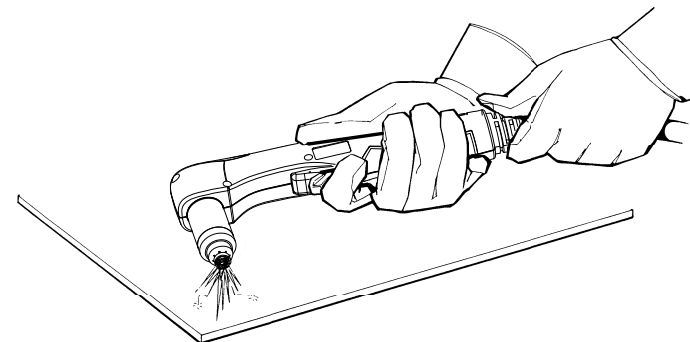

When the pierce is complete, proceed with the cut.

## Gouging



		<p><b>WARNING</b>  <b>SPARKS AND HOT METAL CAN INJURE EYES AND BURN SKIN</b></p>
<p><b>When firing the torch at an angle, sparks and hot metal will spray out from the nozzle. Point the torch away from yourself and others.</b></p>		

Hold the torch so that the nozzle is within 1/16 in (1.5 mm) from the workpiece before firing the torch.

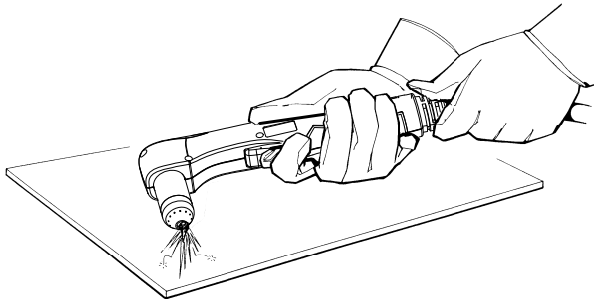

Hold the torch at a 45° angle to the workpiece. Pull the trigger to obtain a pilot arc. Transfer the arc to the work piece.

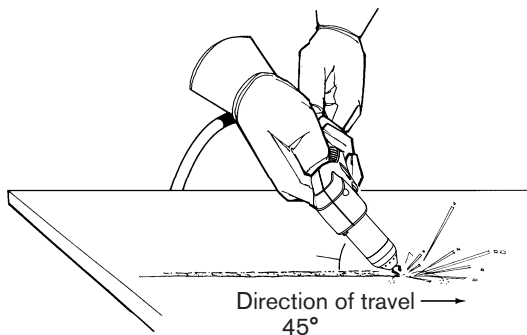

Maintain an approximate 45° angle to the workpiece.

Feed into the gouge.

Note: A heat shield is available for added hand and torch protection (part number 220049).

## Cut charts

### 100 amp mechanized shielded consumables

- Torch-to-work distance for the following cut chart is 1/8 in (3.2 mm) for all cuts.

Shield 220047      Retaining cap 220048      Nozzle 220011      Electrode 220037      Swirl ring 220051      T100M-2 torch

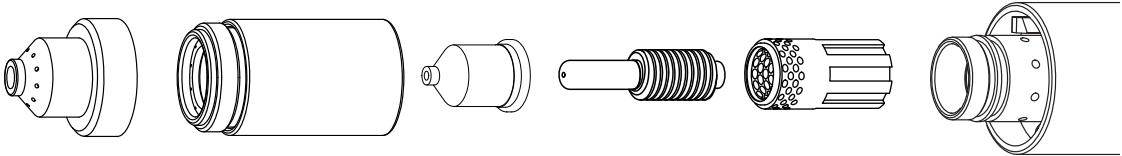

#### Mild steel

Arc current	Arc voltage	Pierce delay	Material thickness		Maximum travel speed		Optimum travel speed	
			Inches	mm	IPM	mm/min	IPM	mm/min
100	153	0.5	1/4"	6.4	208	5283	135	3429
	155	0.5	3/8"	9.5	119	3022	77	1955
	159	1.0	1/2"	12.7	88	2235	57	1447
	160	1.0	5/8"	15.9	61	1549	40	1016
	161	1.5	3/4"	19.0	47	1193	26	660
	163	NA	1	25.4	28	711	18	457
167	1 1/4"		31.8	19	482	12	305	

#### Stainless steel

Arc current	Arc voltage	Pierce delay	Material thickness		Maximum travel speed		Optimum travel speed	
			Inches	mm	IPM	mm/min	IPM	mm/min
100	154	0.5	1/4"	6.4	231	5867	150	3810
	156	0.5	3/8"	9.5	122	3099	79	2006
	161	1.0	1/2"	12.7	79	2006	52	1320
	162	1.0	5/8"	15.9	52	1320	34	863
	164	1.5	3/4"	19.0	39	990	25	635
	166	NA	1"	25.4	23	584	15	381
169	1 1/4"		31.8	14	355	9	228	

#### Aluminum

Arc current	Arc voltage	Pierce delay	Material thickness		Maximum travel speed		Optimum travel speed	
			Inches	mm	IPM	mm/min	IPM	mm/min
100	154	0.5	1/4"	6.4	253	6426	164	4165
	157	0.5	3/8"	9.5	142	3606	92	2336
	160	1.0	1/2"	12.7	108	2743	70	1778
	161	1.0	5/8"	15.9	77	1955	50	1270
	162	1.5	3/4"	19.0	57	1447	33	838
	165	NA	1"	25.4	33	838	21	533

Maximum travel speeds are the fastest speeds possible for cutting the material without regard to cut quality. Optimum travel speeds provide the best cut angle, least dross and best cut surface finish. **Remember that cut charts are intended to provide a good starting point for each different cut assignment.** Every cutting system requires "fine tuning" for each cutting application in order to obtain the desired cut quality.



## 80 amp mechanized shielded consumables

- Torch-to-work distance for the following cut chart is 1/16 in (1.5 mm) for all cuts.

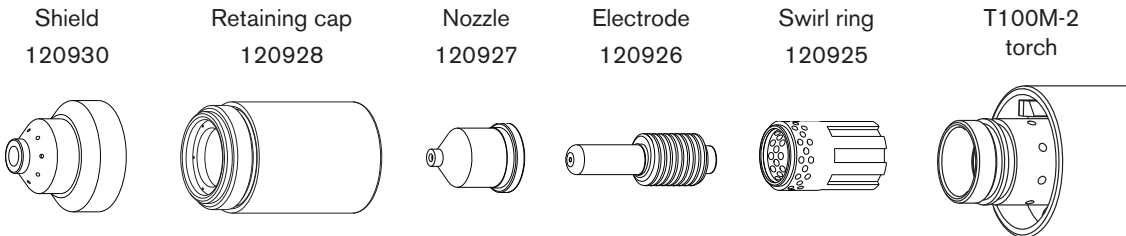

### Mild steel

Arc current	Arc voltage	Pierce delay	Material thickness		Maximum travel speed		Optimum travel speed	
			Inches	mm	IPM	mm/min	IPM	mm/min
80	132	0.25	<b>3/16"</b>	<b>4.8</b>	216	5486	140	3556
	134	0.50	<b>1/4"</b>	<b>6.4</b>	161	4089	105	2667
	137		<b>3/8"</b>	<b>9.5</b>	94	2388	61	1549
	140		<b>1/2"</b>	<b>12.7</b>	60	1524	39	991
	145	1.0	<b>5/8"</b>	<b>15.9</b>	40	1016	26	660
	148	N/A	<b>3/4"</b>	<b>19.0</b>	31	787	20	508
	150		<b>7/8"</b>	<b>22.2</b>	23	584	15	381
	156		<b>1"</b>	<b>25.4</b>	16	406	10	254

### Stainless steel

Arc current	Arc voltage	Pierce delay	Material thickness		Maximum travel speed		Optimum travel speed	
			Inches	mm	IPM	mm/min	IPM	mm/min
80	134	0.25	<b>3/16"</b>	<b>4.8</b>	216	5486	140	3556
	136	0.50	<b>1/4"</b>	<b>6.4</b>	158	4013	103	2616
	139	0.75	<b>3/8"</b>	<b>9.5</b>	83	2108	54	1372
	142		<b>1/2"</b>	<b>12.7</b>	50	1270	33	838
	145	1.0	<b>5/8"</b>	<b>15.9</b>	34	864	22	559
	150	N/A	<b>3/4"</b>	<b>19.0</b>	24	610	16	406
	153		<b>1"</b>	<b>25.4</b>	14	356	9	229

### Aluminum

Arc current	Arc voltage	Pierce delay	Material thickness		Maximum travel speed		Optimum travel speed	
			Inches	mm	IPM	mm/min	IPM	mm/min
80	134	0.25	<b>1/8"</b>	<b>3.2</b>	454	11532	295	7493
	139		<b>1/4"</b>	<b>6.4</b>	176	4470	114	2896
	143	0.75	<b>3/8"</b>	<b>9.5</b>	121	3073	60	1524
	146		<b>1/2"</b>	<b>12.7</b>	75	1905	37	940
	154	N/A	<b>3/4"</b>	<b>19.0</b>	37	940	19	483

Maximum travel speeds are the fastest speeds possible for cutting the material without regard to cut quality. Optimum travel speeds provide the best cut angle, least dross and best cut surface finish. **Remember that cut charts are intended to provide a good starting point for each different cut assignment.** Every cutting system requires "fine tuning" for each cutting application in order to obtain the desired cut quality.

# OPERATION

## 60 amp mechanized shielded consumables

- Torch-to-work distance for the following cut chart is 1/16 in (1.5 mm) for all cuts.

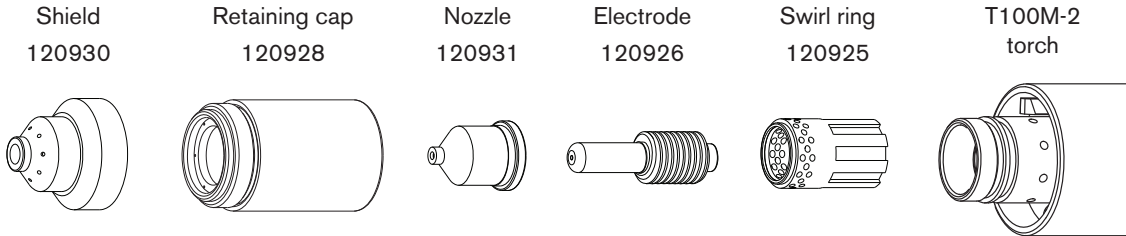

### Mild steel

Arc current	Arc voltage	Pierce delay	Material thickness		Maximum travel speed		Optimum travel speed	
			Inches	mm	IPM	mm/min	IPM	mm/min
60	134	0	<b>16 Ga</b>	<b>1.5</b>	627	15926	502	12751
	134		<b>10 Ga</b>	<b>3.4</b>	264	6706	211	5359
	138	0.25	<b>1/4"</b>	<b>6.4</b>	132	3353	86	2184
	141	0.75	<b>3/8"</b>	<b>9.5</b>	63	1600	41	1041
	141	1.50	<b>1/2"</b>	<b>12.7</b>	42	1067	27	686
	147		<b>5/8"</b>	<b>15.9</b>	31	787	20	512
	147		<b>3/4"</b>	<b>19.0</b>	22	559	14	363
153								

### Stainless steel

Arc current	Arc voltage	Pierce delay	Material thickness		Maximum travel speed		Optimum travel speed	
			Inches	mm	IPM	mm/min	IPM	mm/min
60	134	0	<b>16 Ga</b>	<b>1.5</b>	625	15875	406	10312
	136	0.25	<b>10 Ga</b>	<b>3.4</b>	244	6198	159	4039
	139	0.50	<b>1/4"</b>	<b>6.4</b>	110	2794	72	1829
	145	0.75	<b>3/8"</b>	<b>9.5</b>	53	1346	34	864
	146	2.00	<b>1/2"</b>	<b>12.7</b>	35	889	23	584
	149		<b>5/8"</b>	<b>15.9</b>	26	660	17	429
	149		<b>3/4"</b>	<b>19.0</b>	18	457	12	297
154								

### Aluminum

Arc current	Arc voltage	Pierce delay	Material thickness		Maximum travel speed		Optimum travel speed	
			Inches	mm	IPM	mm/min	IPM	mm/min
60	135	0	<b>1/16"</b>	<b>1.6</b>	666	16916	433	10995
	138	0.25	<b>1/8"</b>	<b>3.2</b>	400	10160	260	6604
	141		<b>1/4"</b>	<b>6.4</b>	145	3683	94	2388
	146	0.75	<b>3/8"</b>	<b>9.5</b>	74	1880	48	1219
	149	1.50	<b>1/2"</b>	<b>12.7</b>	51	1295	30	762
	153		<b>5/8"</b>	<b>15.9</b>	33	838	21	545

Maximum travel speeds are the fastest speeds possible for cutting the material without regard to cut quality. Optimum travel speeds provide the best cut angle, least dross and best cut surface finish. **Remember that cut charts are intended to provide a good starting point for each different cut assignment.** Every cutting system requires "fine tuning" for each cutting application in order to obtain the desired cut quality.

## 40 amp mechanized shielded consumables

- Torch-to-work distance for the following cut chart is 1/16 in (1.5 mm) for all cuts.

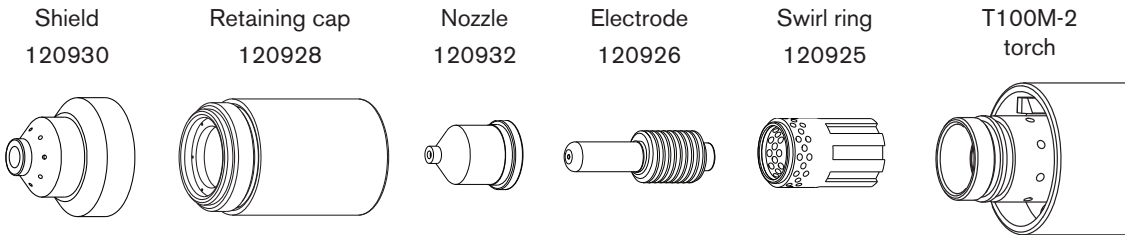

### Mild steel

Arc current	Arc voltage	Pierce delay	Material thickness		Maximum travel speed		Optimum travel speed	
			Inches	mm	IPM	mm/min	IPM	mm/min
25	147		<b>26 GA</b>	<b>0.5</b>	638	16205	415	10541
	148		<b>22 GA</b>	<b>0.8</b>	500	12700	325	8255
	149		<b>18 GA</b>	<b>1.3</b>	312	7925	203	5156
	152		<b>16 GA</b>	<b>1.5</b>	176	4470	114	2896
40	144	0.25	<b>14 GA</b>	<b>1.9</b>	640	16256	221	5613
	146	0.50	<b>10 GA</b>	<b>3.4</b>	151	3835	98	2489
	147	0.75	<b>3/16"</b>	<b>4.7</b>	97	2464	63	1600
	149	1.00	<b>1/4"</b>	<b>6.4</b>	74	1880	48	1219

### Stainless steel

Arc current	Arc voltage	Pierce delay	Material thickness		Maximum travel speed		Optimum travel speed	
			Inches	mm	IPM	mm/min	IPM	mm/min
25	139		<b>26 GA</b>	<b>0.5</b>	631	16027	410	10414
	139		<b>22 GA</b>	<b>0.8</b>	496	12598	322	8179
40	142	0.25	<b>18 GA</b>	<b>1.3</b>	592	15037	335	8509
	144	0.25	<b>16 GA</b>	<b>1.5</b>	374	9500	243	6172
	144	0.25	<b>14 GA</b>	<b>1.9</b>	221	5613	144	3658
	147	0.50	<b>10 GA</b>	<b>3.4</b>	107	2718	70	1778
	149	0.75	<b>3/16"</b>	<b>4.7</b>	67	1702	44	1118
	149	1.00	<b>1/4"</b>	<b>6.4</b>	47	1194	31	787

### Aluminum

Arc current	Arc voltage	Pierce delay	Material thickness		Maximum travel speed		Optimum travel speed	
			Inches	mm	IPM	mm/min	IPM	mm/min
25	150		<b>1/32"</b>	<b>0.8</b>	610	15494	397	10084
	152		<b>1/16"</b>	<b>1.5</b>	268	6807	174	4420
40	146	0.25	<b>3/32"</b>	<b>2.4</b>	293	7442	190	4826
	149	0.50	<b>1/8"</b>	<b>3.2</b>	204	5182	133	3378
	151	1.00	<b>1/4"</b>	<b>6.4</b>	76	1930	49	1245

Maximum travel speeds are the fastest speeds possible for cutting the material without regard to cut quality. Optimum travel speeds provide the best cut angle, least dross and best cut surface finish. **Remember that cut charts are intended to provide a good starting point for each different cut assignment.** Every cutting system requires "fine tuning" for each cutting application in order to obtain the desired cut quality.

# OPERATION

## FineCut consumables

- Torch-to-work distance for the following cut chart is 0.08 inches (2.032 mm) for mild steel and 0.010 inches (0.254 mm) for stainless steel.

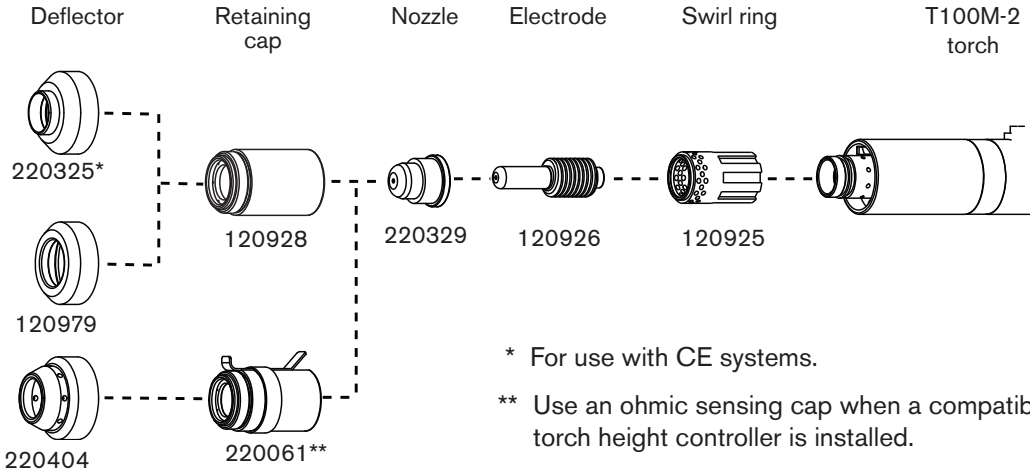

### Mild steel

Arc current	Arc voltage	Material thickness		Approximate travel speeds	
		Inches	mm	IPM	mm/min
50	76	<b>10 Ga</b>	<b>3.4</b>	90	2286
40	83	<b>10 Ga</b>	<b>3.4</b>	50	1270
45	77	<b>12 Ga</b>	<b>2.7</b>	120	3048
40	81	<b>12 Ga</b>	<b>2.7</b>	70	1778
	79	<b>14 Ga</b>	<b>1.9</b>	135	3810
	79	<b>16 Ga</b>	<b>1.5</b>	150	3810
	79	<b>18 Ga</b>	<b>1.2</b>	150	2540
	78	<b>20 Ga</b>	<b>0.9</b>	120	2540
30	80	<b>24 Ga</b>	<b>0.6</b>	150	3174

### Stainless steel

Arc current	Arc voltage	Material thickness		Approximate travel speeds	
		Inches	mm	IPM	mm/min
50	63	<b>10 Ga</b>	<b>3.4</b>	80	1905
40	73	<b>10 Ga</b>	<b>3.4</b>	60	1524
45	63	<b>12 Ga</b>	<b>2.7</b>	100	3174
40	72	<b>12 Ga</b>	<b>2.7</b>	80	1905
	65	<b>14 Ga</b>	<b>1.9</b>	150	3810
	64	<b>16 Ga</b>	<b>1.5</b>	150	3810
	64	<b>18 Ga</b>	<b>1.2</b>	150	3810
	65	<b>20 Ga</b>	<b>0.9</b>	150	3810
30	66	<b>24 Ga</b>	<b>0.6</b>	150	3810

## 100 amp mechanized unshielded consumables

- Torch-to-work distance for the following cut chart is 3/16 in (4.8 mm) for all cuts.

Deflector  
120979

Retaining cap  
220048

Nozzle  
220064

Electrode  
220037

Swirl ring  
220051

T100M-2  
torch

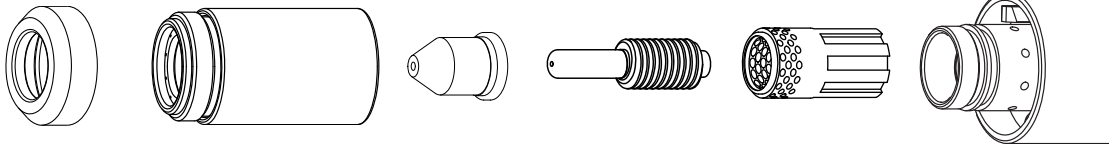

### Mild steel

Arc current	Arc voltage	Pierce delay	Material thickness		Maximum travel speed		Optimum travel speed	
			Inches	mm	IPM	mm/min	IPM	mm/min
100	136	0.5	1/4"	6.4	210	5334	137	3479
	139	0.5	3/8"	9.5	122	3098	79	2006
	142	1.0	1/2"	12.7	91	2311	59	1498
	146	1.0	5/8"	15.9	57	1447	37	939
	150	1.5	3/4"	19.0	43	1092	28	711
	155	NA	1"	25.4	26	660	17	431
160	1 1/4"		31.8	16	406	10	254	

### Stainless steel

Arc current	Arc voltage	Pierce delay	Material thickness		Maximum travel speed		Optimum travel speed	
			Inches	mm	IPM	mm/min	IPM	mm/min
100	136	0.5	1/4"	6.4	241	6121	157	3987
	139	0.5	3/8"	9.5	131	3327	85	2159
	142	1.0	1/2"	12.7	81	2057	53	1346
	146	1.0	5/8"	15.9	51	1295	33	838
	150	1.5	3/4"	19.0	33	838	22	558
	155	NA	1"	25.4	22	558	14	355
161	1 1/4"		31.8	11	279	7	177	

### Aluminum

Arc current	Arc voltage	Pierce delay	Material thickness		Maximum travel speed		Optimum travel speed	
			Inches	mm	IPM	mm/min	IPM	mm/min
100	137	0.5	1/4"	6.4	255	6477	166	4216
	139	0.5	3/8"	9.5	153	3886	99	2514
	142	1.0	1/2"	12.7	107	2717	70	1778
	147	1.0	5/8"	15.9	77	1955	50	1270
	150	1.5	3/4"	19.0	51	1295	33	838
	154	NA	1"	25.4	31	787	20	508

Maximum travel speeds are the fastest speeds possible for cutting the material without regard to cut quality. Optimum travel speeds provide the best cut angle, least dross and best cut surface finish. **Remember that cut charts are intended to provide a good starting point for each different cut application.** Every cutting system requires "fine tuning" for each cutting application in order to obtain the desired cut quality.

## OPERATION

### 40 to 60 amp mechanized unshielded consumables

- Torch-to-work distance for the following cut chart is 1/16 inch (1.5 mm) for all cuts.

Deflector  
120979

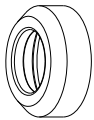

Retaining cap  
120928

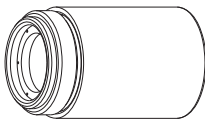

Nozzle  
220006



Electrode  
120926

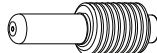

Swirl ring  
120925

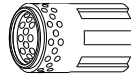

T100M-2  
torch

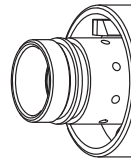

#### Mild steel

Arc current	Arc voltage	Pierce delay	Material thickness		Maximum travel speed		Optimum travel speed	
			Inches	mm	IPM	mm/min	IPM	mm/min
25	125		<b>26 GA</b>	<b>0.5</b>	550	13970	353	8966
	128		<b>22 GA</b>	<b>0.8</b>	484	12294	315	8001
	130		<b>18 GA</b>	<b>1.3</b>	238	6045	155	3937
	131		<b>16 GA</b>	<b>1.5</b>	167	4242	109	2769
40	129	0.25	<b>14 GA</b>	<b>1.9</b>	326	8280	212	5385

#### Stainless steel

Arc current	Arc voltage	Pierce delay	Material thickness		Maximum travel speed		Optimum travel speed	
			Inches	mm	IPM	mm/min	IPM	mm/min
25	127		<b>26 GA</b>	<b>0.5</b>	561	14249	365	9271
	127		<b>22 GA</b>	<b>0.8</b>	453	11506	295	7493
40	123	0.25	<b>18 GA</b>	<b>1.3</b>	500	12700	325	8255
	127	0.25	<b>16 GA</b>	<b>1.5</b>	367	9322	239	6071
	128	0.25	<b>14 GA</b>	<b>1.9</b>	220	5588	143	3632

#### Aluminum

Arc current	Arc voltage	Pierce delay	Material thickness		Maximum travel speed		Optimum travel speed	
			Inches	mm	IPM	mm/min	IPM	mm/min
25	125		<b>1/32"</b>	<b>0.8</b>	564	14326	366	9296
	127		<b>1/16"</b>	<b>1.5</b>	236	5994	153	3886
40	127	0.25	<b>3/32"</b>	<b>2.4</b>	261	6629	170	4318

Maximum travel speeds are the fastest speeds possible for cutting the material without regard to cut quality. Optimum travel speeds provide the best cut angle, least dross and best cut surface finish. **Remember that cut charts are intended to provide a good starting point for each different cut assignment.** Every cutting system requires "fine tuning" for each cutting application in order to obtain the desired cut quality.

## Section 5



# MAINTENANCE AND PARTS

---



*In this section:*

Routine maintenance.....	5-2
Inspect the consumables.....	5-3
Filter element replacement .....	5-4
Controls and indicators .....	5-5
Basic troubleshooting.....	5-6
System circuit diagram .....	5-9
Technical questions.....	5-10
Parts.....	5-10
Torch parts.....	5-10
Power supply parts.....	5-11
Accessories.....	5-11

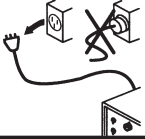
## Routine maintenance

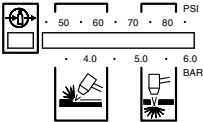
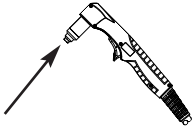
		<p><b>WARNING</b> <b>ELECTRIC SHOCK CAN KILL</b></p>
 <p><b>Disconnect the electrical power before performing any maintenance. All work requiring removal of the power supply cover must be performed by a qualified technician.</b></p>		

 <p><b>Each Use</b></p>	 <p>Check the gas pressure.</p>	 <p>Check the consumables for wear and proper installation.</p>
--	--	---

 <p><b>Each Week</b></p>	 <p>Check the torch cap-on safety switch: observe that red fault LED and yellow torch cap LED illuminate when cap is loosened.</p>
---	---



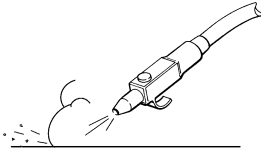
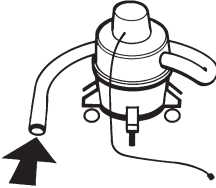

 <p><b>3 Months</b></p>	 <p>Replace damaged labels.</p>	 <p>Check the trigger for damage. Check the torch body for cracks or exposed wires.</p>
---	---	--

 <p>Replace power cord or plug if damaged.</p>	 <p>Replace torch lead if damaged.</p>	 <p>Check the pressure hose, filter element, and connections for leaks.</p>
---	---	---

 <p><b>6 Months</b></p>	  <p>Clean the inside of the power supply with air pressure or vacuum.</p>
--	--

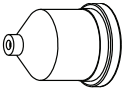

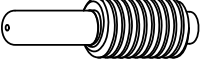
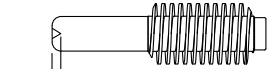
**Inspect the consumables**

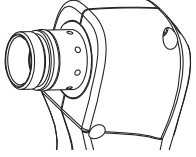
<b>Part</b>	<b>Check for</b>	<b>Action</b>
 <p><b>Nozzle</b> Center hole</p>	<p>Roundness of through hole</p>  <p>Good</p>  <p>Worn</p>	<p>Replace</p>
 <p><b>Electrode</b> Center surface</p>	 <p>Max. 1/32 inch (0.8 mm)</p> <p>Maximum pit depth 1/32 inch (0.8 mm)</p>	<p>Replace</p>
 <p><b>Swirl ring</b> External surfaces Central bore (I.D.) Gas holes</p>	<p>Damage or debris</p> <p>Does electrode slide easily?</p> <p>Blocked holes</p>	<p>Replace</p> <p>Replace</p> <p>Replace</p>
 <p><b>Torch o-ring</b> External surfaces</p>	<p>Damage or wear</p> <p>Dry surface</p>	<p>Replace</p> <p>Apply a thin film of silicone grease (part number 027055)</p>

## Filter element replacement

1. Disconnect the electrical power and the gas supply. Remove the filter bowl.
  - A. Pull down and hold the black release tab. (If you do not see the tab, check the back of the filter bowl.)
  - B. Rotate the filter bowl in either direction until it releases.
  - C. Pull the filter bowl down to remove it. The bowl has an o-ring around the top. Do not discard the o-ring.

If the o-ring shows signs of wear or otherwise needs replacement, verify that you have the correct o-ring for the filter. (Each filter has a label on one side of the filter body.)

- For AF30 filters, use part number 011105.
- For NAF3000 filters, use part number 011094.

2. Use a screwdriver to remove the filter element from the filter housing. Then install the new filter element.

Note: Do not allow the filter element to turn when loosening the screw.

3. Re-install filter bowl.

- A. Hold down the black tab and slide the filter bowl over the filter element.
- B. Align the marks on filter bowl and the filter body.
- C. Rotate the filter bowl until it locks in place.

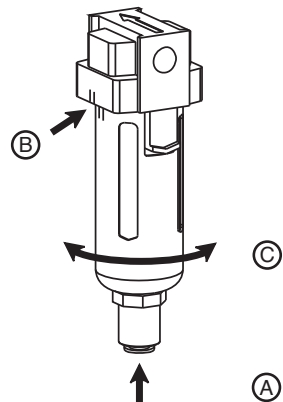
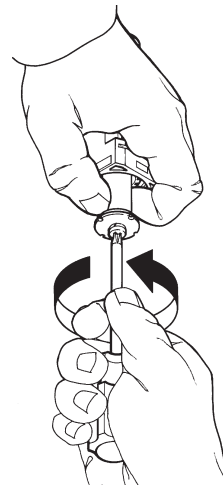
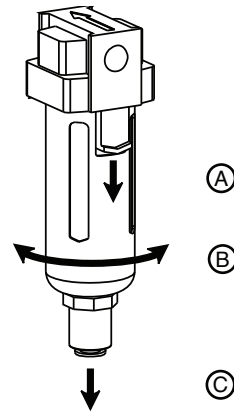

## Basic troubleshooting

### Problem

1. The ON/OFF power switch is set to I (ON), and the power ON (green) lamp is not illuminated.



Note: The fan turns on automatically. The fan may not be in operation when the power is ON.

### Cause / Solution

- 1.1 **The power cord is not plugged into the power receptacle.**  
Plug the power cord into the receptacle.
- 1.2 **The disconnect power switch is not set to ON or there is no power available to the disconnect power switch box.**  
Turn on the power at the main power panel or at the disconnect power switch box.

2. The power ON (green), low gas - pressure (yellow) is flashing and fault (Red) lamps are illuminated.



- 2.1 **The gas supply is turned OFF or not connected to the power supply.**  
Check that the gas is turned on and is connected to the power supply.

- 2.2 **The gas supply pressure is too low.**  
Set the incoming gas supply pressure to 90-120 psig / 6.2-8.3 bar. Check that there are no leaks in the gas supply line.

- 2.3 **Operating gas pressure is set too low for the selected mode.**  
Adjust the operating gas pressure. See Section 4 for pressure settings.

3. The power on, line voltage (yellow) and fault (red) lamps are illuminated.



- 3.1 **The line voltage is too low, too high, or a phase is missing.**  
Have a qualified technician check the incoming power.

## Basic troubleshooting (continued)

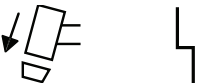
Problem	Cause / Solution
<p>4. The power ON (green), temperature (yellow) and fault (red) lamps are illuminated.</p>	<p><b>4.1 One of the internal thermostat switches has opened due to overheating or extremely low temperature.</b></p>
	<p>Leave the power supply ON to allow the fan to cool the power supply (overheating). Move the power supply to a warm location (extreme cold).</p>
<p>5. The power ON (green), torch parts loose or removed (yellow) and fault (red) lamps are illuminated.</p>	<p><b>5.1 The retaining cap is loose or removed from the torch.</b></p>
	<p>Turn off the power supply and tighten or install the torch consumables. See Section 4, <i>Installing the consumables</i>.</p>
<p>6. The arc does not transfer to the workpiece.</p>	<p><b>6.1 The work clamp is not connected to the workpiece, the work clamp is broken, or there is a loose connection within power supply.</b></p>
	<p>Connect or repair the work clamp.</p>
	<p><b>6.2 The work clamp is not making good metal-to-metal contact.</b></p>
	<p>Clean the area where the clamp contacts the workpiece.</p>
	<p><b>6.3 The torch is too far from the workpiece.</b></p>
	<p>Move the torch closer to the workpiece and start the torch again.</p>
	<p>See Section 4, <i>Torch operation</i>.</p>

## Basic troubleshooting (continued)

<b>Problem</b>	<b>Cause / Solution</b>
<b>7. The arc blows out, but re-ignites when the torch switch is pressed again.</b>	<p><b>7.1 <i>The consumable parts are worn or damaged.</i></b> Inspect and change the consumables, as necessary. See <i>Inspect the consumables</i>, in this section. See Section 4, <i>Torch operation</i>.</p> <p><b>7.2 <i>The gas pressure is incorrect.</i></b> Adjust the operating gas pressure. See Section 4, <i>Check and adjust the gas pressure</i>. Check that the gas supply pressure to the power supply is not less than 90 psig (6.1 bar) at a flow of 9.2 scfm (260 l/min).</p> <p><b>7.3 <i>The gas filter element outside the power supply is contaminated.</i></b> Replace the filter element. See <i>Air filter element replacement</i>, in this section.</p>
<b>8. The arc sputters and hisses.</b>	<p><b>8.1 <i>The gas filter element outside the power supply is contaminated.</i></b> Replace the filter element.</p> <p><b>8.2 <i>There is water in the air line.</i></b> Drain the air filter(s) and/or add additional air filtration to the power supply. See Section 3, <i>Additional gas filtration</i>.</p> <p><b>8.3 <i>Worn or incorrectly installed consumables.</i></b> Inspect the consumables. Replace them if necessary.</p>
<b>9. Cut quality is not good.</b>	<p><b>9.1 <i>Consumables are worn or the torch is being used incorrectly.</i></b> See <i>Inspect the consumables</i>, in this section. See Section 4, <i>Hand torch operation</i>.</p>

## Basic troubleshooting (continued)

<b>Problem</b>	<b>Cause / Solution</b>
<b>10. The power ON (green) and fault (red) lamps are flashing.</b>	<b>10.1 <i>Self-diagnostic failure.</i></b> The system needs repair.
<b>11. The power ON (green) and fault (red) lamps are illuminated after the power is turned on.</b>	<b>11.1 <i>The start signal is ON when the ON/OFF switch is activated.</i></b> Turn the start signal OFF. Turn the power OFF and then ON again.
<b>12. The power ON (green) and fault (red) lamps are illuminated for 10 seconds after the trigger is activated.</b>	<b>12.1 <i>The consumables are stuck or jammed.</i></b> Turn the power OFF and check the consumables.

# System circuit diagram

Designator	Component
D1	Input diode bridge
D2	Output diode bridge
L1	Boost inductor
L2	Output inductor
M1	Fan
PCB1	EMI filter board
PCB2	Power board
PCB3	Control board
PS1	Pressure sensor
Q1	Boost IGBT
Q2	Inverter IGBT
Q3	Pilot arc IGBT
S1	On/off switch
J1	Connector
TS1, TS2	Heatsink temperature sensor
TS3	Transformer temperature sensor
T2	Power transformer
V1	Solenoid valve

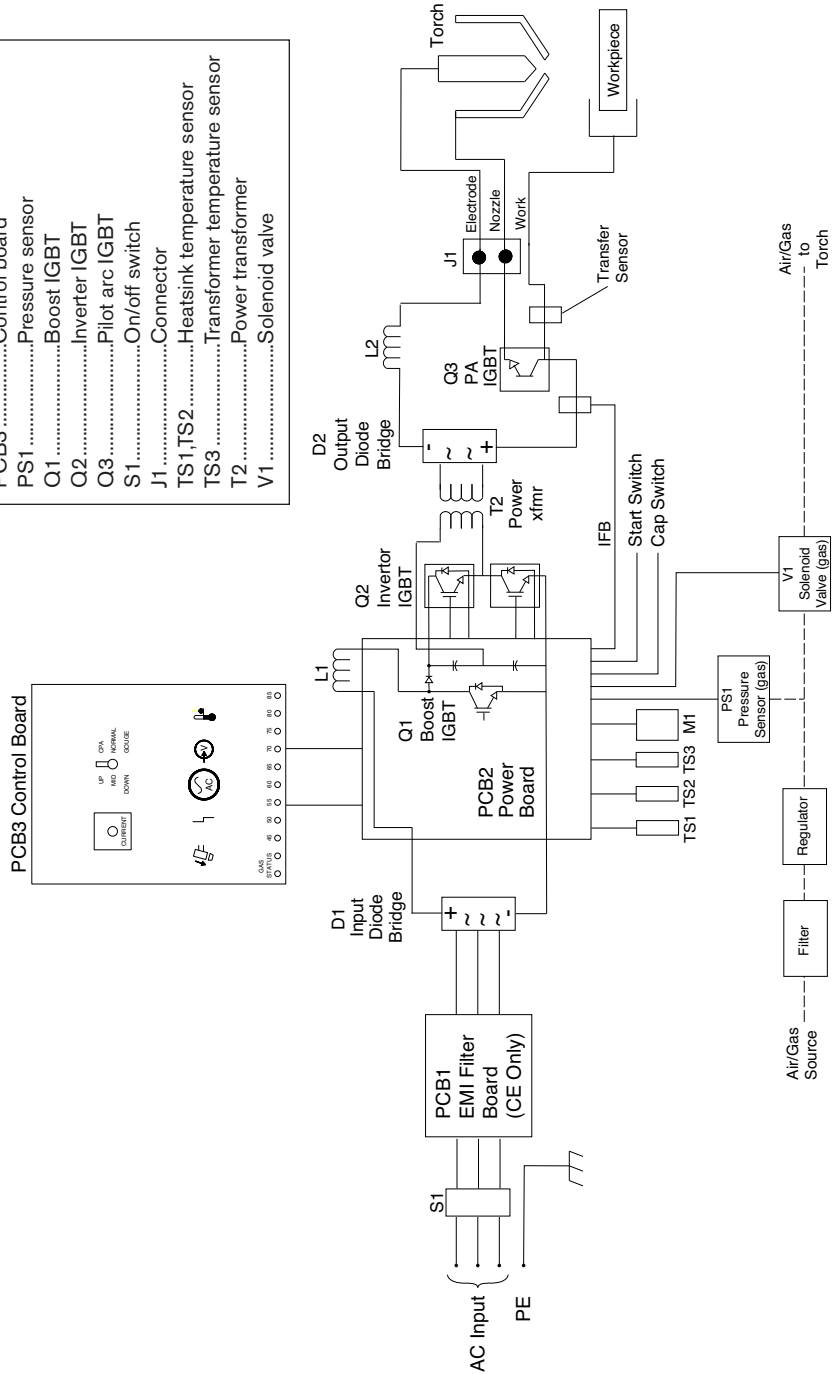

### Technical questions

If you are unable to fix a problem with your Powermax by following the steps in *Basic troubleshooting* in this section, or if you need further assistance:

1. Call your Hypertherm distributor or authorized Hypertherm repair facility.
2. Call the nearest Hypertherm Technical Service team listed in the front of this manual.

### Parts

#### Torch parts

059264	T100 hand torch assembly, 25 ft (7.5 m)
059270	T100 hand torch assembly, 50 ft (15 m)
059299	T100 hand torch assembly, 75 ft (22.9 m)
059315	T100M-2 machine torch assembly, 25 ft (7.5 m)
059324	T100M-2 machine torch assembly, 35 ft (10.7 m)
059325	T100M-2 machine torch assembly, 50 ft (15 m)
059326	T100M-2 machine torch assembly, 75 ft (22.9 m)
059333	T100M-2 machine torch, 35 mm (no gear rack), 25 ft (7.5 m)
059334	T100M-2 machine torch, 35 mm (no gear rack), 35 ft (10.7 m)
059335	T100M-2 machine torch, 35 mm (no gear rack), 50 ft (15 m)
059336	T100M-2 machine torch, 35 mm (no gear rack), 75 ft (22.9 m)
027055	Silicone grease, 1/4 oz. tube
015337	Quick disconnect nipple: 1/4 NPT steel (CSA)
015145	Adapter: 1/4 NPT x G1/4 BSPP brass (CE)
058519	Torch o-ring
128644	T100 hand torch handle replacement kit (5 screws included)
075586	T100 hand torch handle screw (5 required)
220061	Shield cap: T60M/T80M ohmic contact
220206	Shield cap: T100M-2 ohmic contact



**Power Supply Parts**

128740	Cover assembly, CSA (14 screws included)
128762	Cover assembly, CE (14 screws included)
075533	Cover screws (Individual cover screw)
128627 011092	Air filter bowl with fittings Replacement filter element
129654	ETR door assembly
129405	Consumable box
123654	20 ft ground clamp with cable and strain-relief
128750	Kit: Powermax1650 labels, CSA
128758	Kit: Powermax1650 labels, CE

**Accessories**

128788	Stationary mounting kit
128647 011092	Optional air filtration kit Replacement filter for optional air filtration kit
027668	Plasma cutting guide – deluxe
127102	Plasma cutting guide – basic
027684	Replacement bushing for the plasma cutting guide assembly
127100	Powermax1650 dust cover
123655	50 ft (15M) work cable with clamp and strain-relief
023206	CNC interface cable
220049	Gouging heat shield for hand torch
128650	On/off pendant for machine torch, 25 ft (7.5 m)
128651	On/off pendant for machine torch, 50 ft (15 m)
128652	On/off pendant for machine torch, 75 ft (22.9 m)
024548	Leather torch lead sheathing
128888	FineCut kit: Powermax1000/1250/1650
128889	FineCut kit: Powermax1000/1250/1650 CE
804470	Powermax1650 service manual

