

DELTA

Respiratory protection in hard hat working areas

Delta 90 SFA and Delta+ 90 XFA models provide head protection for welding and fabrication personnel working in extreme conditions, such as shipbuilding, heavy fabrication, mining and construction sites.

Delta respirator systems channel clean breathing air over the welder's face from either a rechargeable, Li-Ion battery powered filter pack or locally supplied breathing air source. The adjustable face seal, combined with the 'positive air pressure' design, creates a comfortable breathing zone certified to TH2 European standards, ensuring that 98% of contaminated air remains outside the breathing zone.

- Certified to EN 12941 TH2 and AS/NZS 1716
- Positive pressure design makes breathing effortless
- Li-Ion battery powered filter pack or regulated supplied air breathing system
- Mounting for optional high quality ear defenders



Welding helmets



Delta 90

Heavy duty hard hat and welder's visor meeting EN 397, EN 175, AS/NZS 1801 and AS/NZS 1337.1 (not certified for grinding operations). Includes SA 47 ADF lens.



Delta+ 90

Delta+ 90 XFA has a large and clear impact rated visor.

Note: If using Delta/Delta+ as standalone welding helmets the fabric face seal must be removed before use.

Respiratory protection



Optional ear defenders

Delta and Delta+ models connect with optional quality ear defenders.



Delta 90 SFA / Delta+ 90 XFA (PAPR)

Integrating head, face and respiratory protection for welding in designated head protection work areas. Features battery powered filter unit and ADF lens. (Page 23)



Delta 90 SFA / Delta+ 90 XFA (Airline)

Integrating head, face and respiratory protection for welding in designated head protection work areas. Features supplied air regulator and ADF lens specification. (Page 23)

Integrated head, face and respiratory protection for welders and fabricators

DELTA+ 90 XFA

+ FA Flow Control



Delta+ 90 XFA + FA Flow Control 9873320

Delta+ 90 XFA welding helmet, auto-darkening welding filter XA 47, air hose, FA Flow Control unit, Li-ion battery and charger, flow meter, comfort belt.

Spare parts

Delta+ 90 XFA welding helmet	9873069
Protection plate, 10 pcs	W007520
ADF welding filter XA 47 (shades 9-15, size 90 x 110)	SP9873063
Inner protection plate for SA 47 / XA 47 (104 x 54), 5 pcs	SP012952
Welding visor	W009234
Grinding visor	W009233
Fixing screws, 2 pcs	W007518
Headband	W007519
FA Flow Control unit with Li-ion battery	W013560
Filter cover for FA Flow Control	W013565
Basic filter, 2 pcs	W007490
Sealing ring for FA Flow Control	W007491
Pre-filter for FA Flow Control, 10 pcs	W007492
Odor filter for FA Flow Control, 10 pcs	W007494
Air hose	W007487
Hose protection cover	W007788
Li-ion battery, 4.4 Ah	W007507
Li-ion battery charger	W013564
Flow meter	W007488

Magnifying lenses

Diopter 1.0 (51 x 108 mm)	9873260
Diopter 1.5 (51 x 108 mm)	9873261
Diopter 2.0 (51 x 108 mm)	9873262
Diopter 2.5 (51 x 108 mm)	9873263

Accessories

Face seal	W007516
Protective head cover	W007827
Protective neck cover	W007828
Ear muffs, no 12	W007517
Comfort belt	W007489
Heavy duty comfort belt	W007789
Kemppi Tool bag	SP010090

W007520



SP9873063

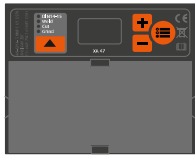

SP012952

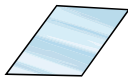

W009234

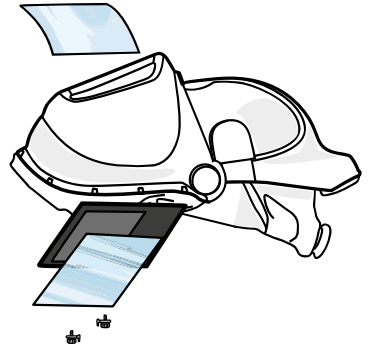
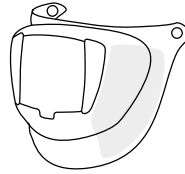

9873260

9873261

9873262

9873263

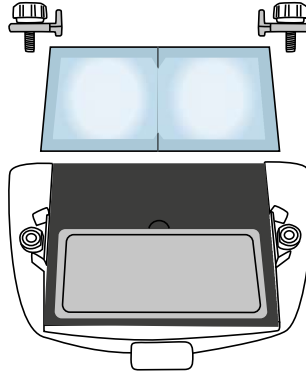

9873069

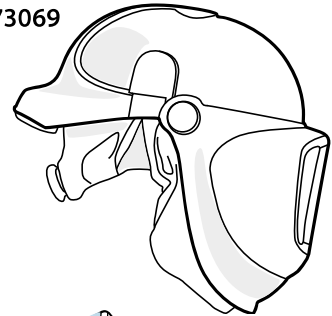

W007519

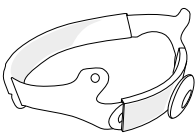

W009233

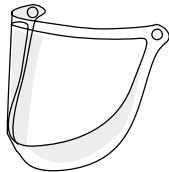

W007518



W009233

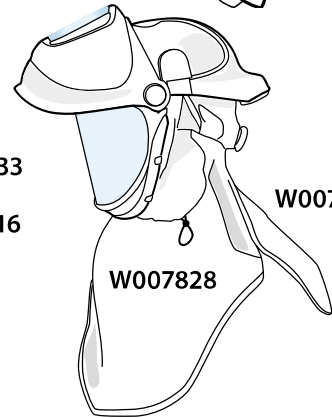

W007827

W007517



W007516

W007828

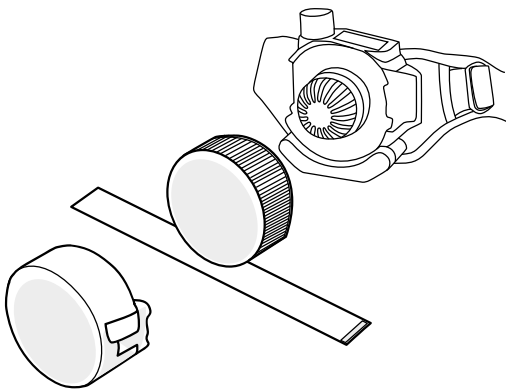

W013565

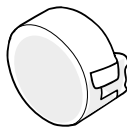

W007490

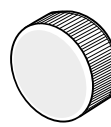

W007491

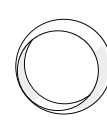

W007492
W007494

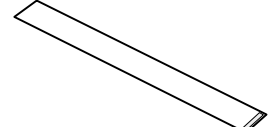

W007788

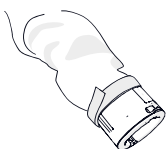

W007487

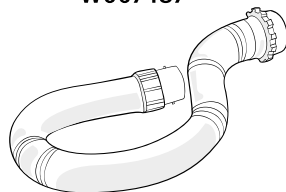

W007789

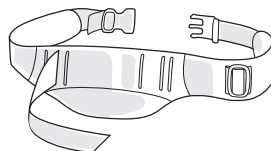

W007489

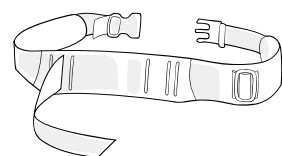

SP010090



W007488



W007507

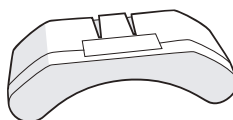

W013564

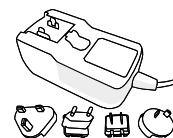

ORDERING CODES

DELTA+ 90 XFA

+ FA Pressure Flow Control



Delta+ 90 XFA + FA Pressure Flow Control 9873321

Delta+ 90 XFA welding helmet, auto-darkening welding filter XA 47, FA Pressure Flow Control unit, flow meter, belt for FA Pressure Flow Control, grinding visor.

Spare parts

Delta+ 90 XFA welding helmet	9873069
Protection plate, 10 pcs	W007520
ADF welding filter XA 47 (shades 9-15, size 90 x 110)	SP9873063
Inner protection plate for SA 47 / XA 47 (104 x 54), 5 pcs	SP012952
Welding visor	W009234
Grinding visor	W009233
Fixing screws, 2 pcs	W007518
Headband	W007519
FA Pressure Flow Control unit with pressure hose	W007515
Air hose	W007501
Hose protection cover	W007788
FA Pressure Flow Control unit	W007496
Silencer for FA Pressure Flow Control	W007498
Valve cap for FA Pressure Flow Control	W007499
Fitting for FA Pressure Flow Control	W007500
FA Pressure Conditioner unit	W007504
Filter for FA Pressure Conditioner	W007505
Flow meter	W007503

Magnifying lenses

Diopter 1.0 (51 x 108 mm)	9873260
Diopter 1.5 (51 x 108 mm)	9873261
Diopter 2.0 (51 x 108 mm)	9873262
Diopter 2.5 (51 x 108 mm)	9873263

Accessories

Face seal	W007516
Protective head cover	W007827
Protective neck cover	W007828
Ear muffs, no 12	W007517
Belt for FA Pressure Flow Control unit	W007502
Spiral hose, 10 m	W007506
Kemppi Tool bag	SP010090

W007520



SP9873063

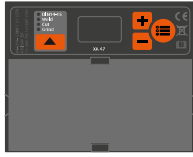

SP012952

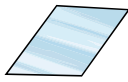

W009234

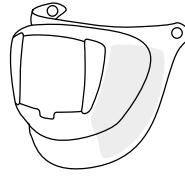

9873069

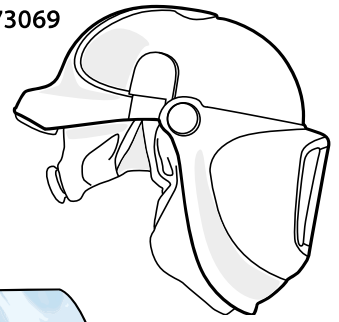

9873260

9873261

9873262

9873263

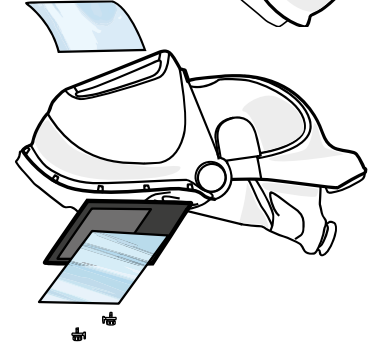
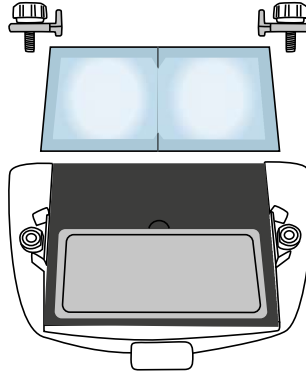

W007519

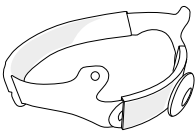

W009233

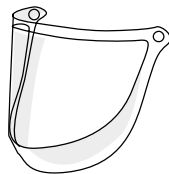

W007518



W009233

W007516

W007827

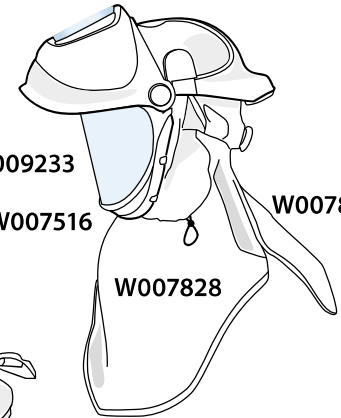

W007496

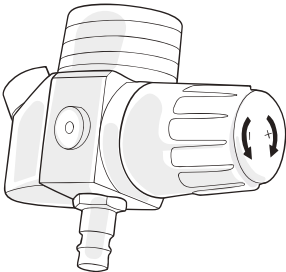

W007788

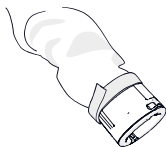

W007517

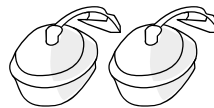

W007828

W007498



W007501

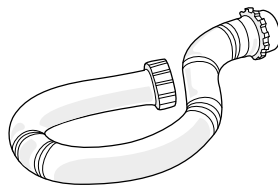

W007506

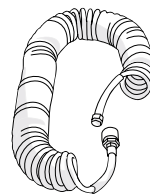

W007502

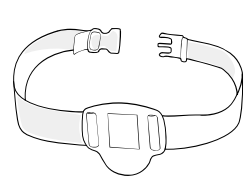

SP010090



W007499

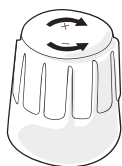

W007500

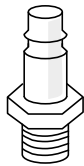

W007503

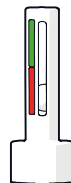

W007504

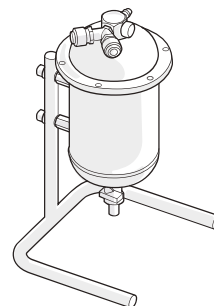

W007505

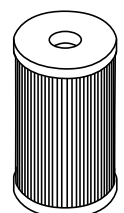

ORDERING CODES